

## APPENDIX 1

**Appendix 1.1: Authorized Strengths of US Infantry Regiments on selected dates 1861-1900**

	COL	LTC	MAJ	Adj	QM	Commissary Officer	Sgt Maj	QM Sgt	Commissary Sgt	Band (3)	Cook	Number Of Companies
1861 Old Army	1	1	2	*1	*1		1	1		2		10
1861 New Army (1)	1	1	3	*4	*4		3	3		27		24
1861 Volunteers (2)	1	1	1	*1	*1		1	1	1	26		10
1867	1	1	1	1	1		1	1	1	2		10
1874-75 (4)	1	1	1	1	1		1	1		3		10
1878	1	1	1	1	1		1	1		3		10
1880	1	1	1	1	1		1	1		3		10
1885	1	1	1	1	1		1	1		3		10
1896 (5)	1	1	1	1	1		1	1		3		8
1898 (war) (6)	1	1	3	4	4		6	4	1	27		12
1900 (6)	1	1	3	4	4	1	4	4	1	27	1	12

\*Detailed from the companies.

Notes:

(1) Staff members shown are total for the regimental headquarters and three battalions. Each battalion had a major, an adjutant, a quartermaster (who did not serve with the battalion unless it was detached from the regiment), a sergeant major and a quartermaster sergeant. All the adjutants and quartermasters were lieutenants. Each New Army battalion and each Volunteer regiment also had a hospital steward (not shown).

(2) Each volunteer regiment also included a surgeon and an assistant surgeon. Surgeons for Regular Army regiments were attached from the Medical Department.

(3) Bands reduced to two (three in the New Army regiments) principal musicians in September 1862.

(4) From 1874 each regiment included a chief musician as well as two principal musicians. The post (or posts) at which a regiment was stationed would furnish a commissary sergeant and a hospital steward. Each regiment also had one chaplain attached to it from the Chaplain Corps.

(5) By 1896 each infantry regiment had "skeletonized" two of its companies. The officers from these companies served as inspectors of militia units and taught "military science" at land grant colleges while the men were used to strengthen the remaining companies.

(6) An 1898 or 1900 regiment had three battalions with a major, an adjutant, a quartermaster, a sergeant major, a quartermaster sergeant, and four companies each. The regimental adjutant and quartermaster were captains. The battalion adjutants and quartermasters and commissary were lieutenants. Two sergeants major shown for the 1898 regiment were actually color sergeants who served as senior clerks in the regimental headquarters and carried the regimental colors on parade (or in battle).

Source: U.S. Army *Registers* for 1860-1898 (all published Washington DC by the Adjutant General).

**Appendix 1.2: Authorized Strengths of US Infantry Companies on selected dates 1861-1900**

	CPT	LT	1Sgt	QM Sgt	Sgt	Cpl	Music	Artificer	Wagoner	Cook	Pvt.	Total
1861 Old Army	1	2	1		3	4	2				*42	55
1861 New Army	1	2	1		4	8	2				82	100
1861 Volunteers	1	2	1		4	8	2		1		*64	83
1867	1	2	1	1	4	8	2	2	1		*50	72
1874-75	1	2	1		4	4	2	2	1		**46	63
1878	1	2	1		4	4	2	2	1		23	40
1880	1	2	1		4	4	2	2	1		34	51
1885	1	2	1		4	4	2	2	1		36	53
1896	1	2	1		4	4	2	2	1		51	68
1898 (war)	1	2	1	1	4	12	2	1	1		84	109
1900	1	2	1	1	4	12	2	1		2	#88	114

\* In June 1850 Congress authorized the President to increase the number of privates to 74 per company in any regiment serving on the western frontier or in other distant stations. The Act of July 22, 1861 directed Volunteer regiments to have a minimum of 64 and a maximum of 82 privates per company. By law, an 1867 regiment could have up to a maximum of 100 privates per company.

\*\* As of 1875 the number of privates per company was reduced to 40 in 13 infantry regiments; to 36 per company in two other regiments; and to 26 per company in the remaining 10 regiments.

# Companies serving in the Philippines were authorized a maximum of 105 privates.

Source: U.S. Army *Registers* for 1860-1898 (all published Washington DC by the Adjutant General).

### Appendix 1.3

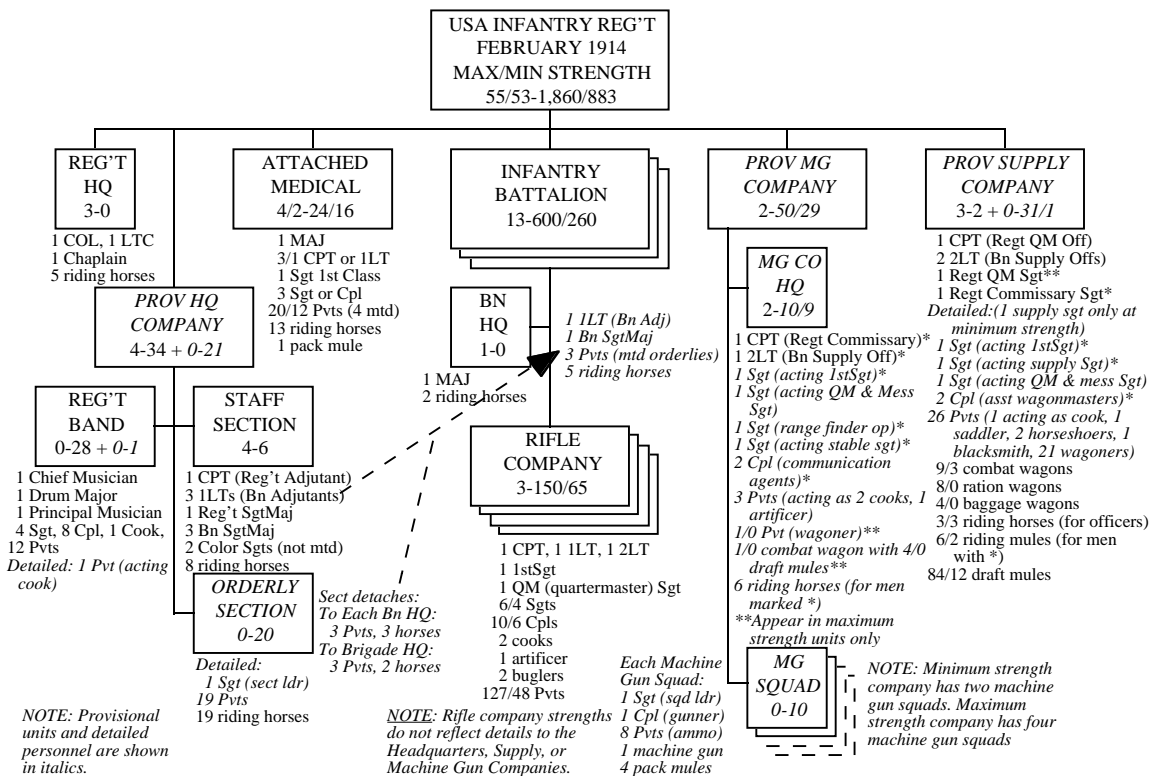

**Notes:**

**Small Arms:** All officers, sergeants major, first sergeants, color sergeants, quartermaster and commissary sergeants, company musicians and regimental band and machinegun company members carried pistols or revolvers. All other members of the regiment (except medical personnel, who were only “attached” and not members) carried rifles. The soldiers detailed to serve as mounted orderlies carried pistols in addition to their rifles.

**Minimum Strength Regiments:** With only 65 men a rifle company in one of these regiments was too small to detach many men to fill out the regiment’s provisional companies. Therefore the Army allowed each minimum strength regiment 50 or so additional men so it could staff the provisional headquarters and machinegun companies without dipping into their already weak rifle companies. For administrative purposes all these extra men were carried on the rifle companies’ muster rolls even though they were permanently detached from them. Thus a 65-man company might actually have 69 on its rolls to reflect those men that it had permanently detached (mainly to the machinegun company and the orderly section). However, these tables provided no additional men to drive the three combat wagons that the Army allowed for a minimum strength supply company.

Source: General Staff of the US Army, “Tables of Organization” (Washington DC 25 February 1914).

## APPENDIX 2

### Appendix 2.1

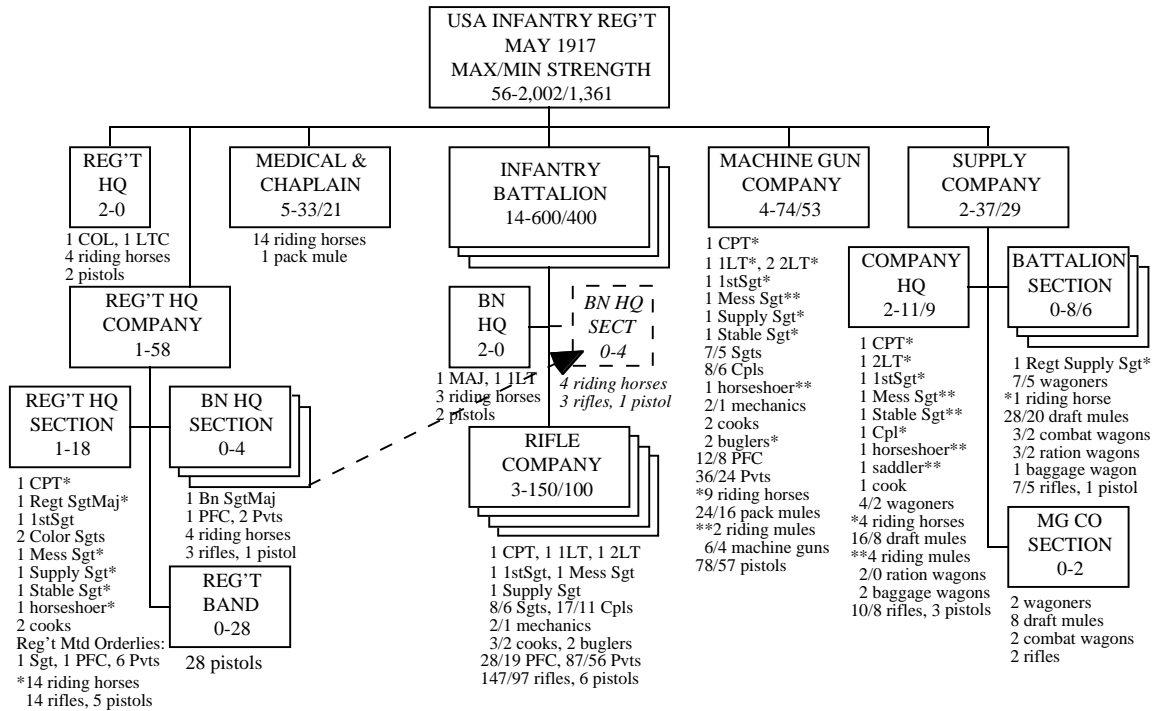

**Notes:**

**Rifle Companies:** Designed to form 16 (eight-man) squads at maximum strength or 10 at minimum strength. Approximately one quarter of all private soldiers are ranked as privates first class (PFC).

**Battalion headquarters:** The battalion adjutants (all ranking as first lieutenant) are now permanent members of their respective battalions and are no longer attachments from the regimental headquarters company. However, the enlisted members of each battalion headquarters (a sergeant major and three messenger/orderlies) are attached from the regimental headquarters company. Instead of a supply officer (as in 1914) each battalion had a regimental supply sergeant (who ranked with a sergeant major) to handle its logistics. The War Department probably made this change so as not to exceed Congressionally mandated limits on the number of officers per regiment while making a sufficient number of officers available to command the machinegun company. Like the battalion supply officer of 1914 a regimental supply sergeant was a member of the supply company and served with it in support of his respective battalion but would not be attached to it unless the battalion was serving away from the rest of the regiment.

**Machinegun Company:** Organized as two platoons with two or three machinegun squads in each. A second lieutenant commanded each platoon and the first lieutenant served as company reconnaissance officer (supervising range finding and selecting firing positions). A machinegun squad had a sergeant, a corporal, up to eight privates and four pack mules. One sergeant operated the company range finder. Two corporals served as (mounted) communication agents.

**Supply Company:** Maintained separate sections of vehicles and drivers for the machinegun company and each battalion. These sections were not normally attached to the units they supported (unless those units were operating away from the rest of the regiment) but operated under supply company control.

**Small Arms:** All officers, sergeants major, regimental supply sergeants, color sergeants, buglers, band members, machinegun company members, armed with pistols or revolvers. All others (except attached medical personnel and the chaplain, all officially unarmed) carried rifles.

**Source:** US War Department, *The United States Army in the World War Vol 1, Organization* (Washington DC, Center of Military History 1988, first printed 1948) War Dept Document No 571, May 3 1917, Tables 2 and 3; pp. 162-163.

## Appendix 2.2

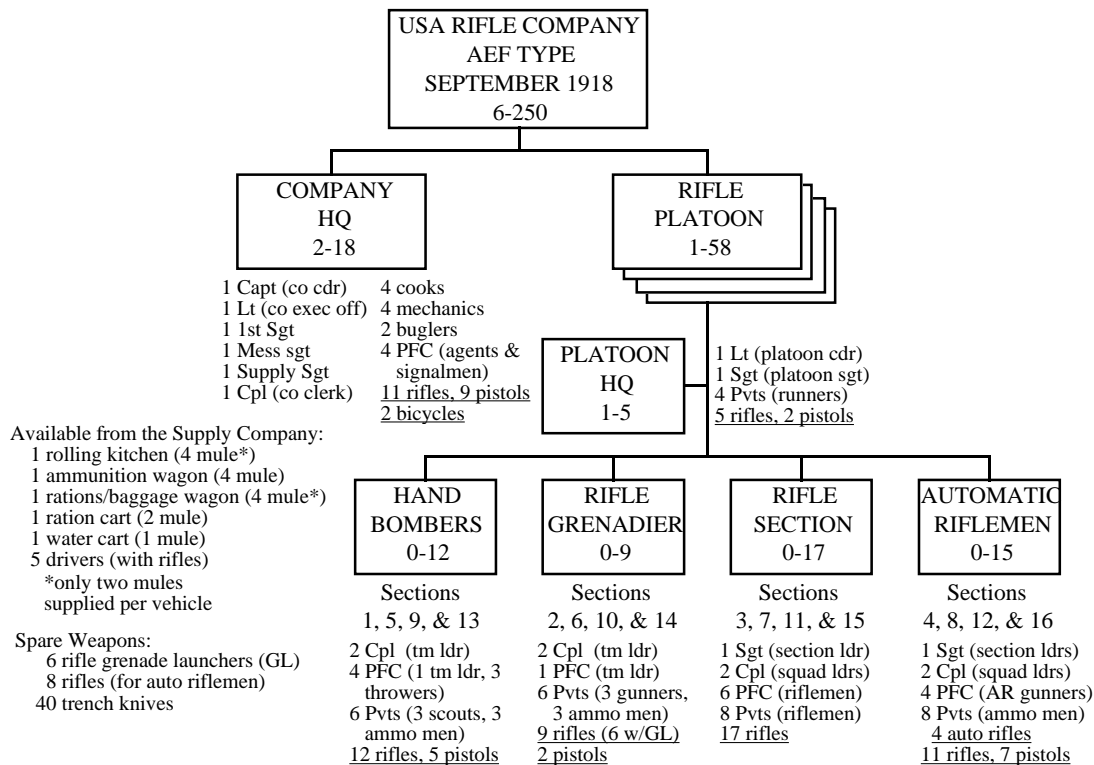

**Notes:**

**Company Headquarters:** The company commander, the first sergeant, two buglers and four PFC (agents and signalmen) are in the "Captain's Group." All others are in the service group.

**Rifle Platoon:** Composed of a headquarters and one hand bomber section, one rifle grenadier section, one rifle section and one automatic rifle section each. The platoon organized itself for combat by establishing two "half platoons" under the rifle and automatic section leaders, respectively. Each half platoon would have one squad from the rifle section, one squad from the automatic rifle section, and one or possibly two additional squads assembled from members of the hand bomber and rifle grenadier sections and platoon headquarters.

**Hand Bomber Section:** Organized as three teams with a leader, a thrower, a scout, and an ammunition bearer in each.

**Rifle Grenadier Section:** Organized as three teams with a leader (who was also a grenadier), a grenadier, and an ammunition bearer in each.

**Rifle Section:** Organized as a section leader and two eight-man rifle squads.

**Automatic Rifle Section:** Operated as a section leader and two squads. Each squad had a leader and two automatic rifle teams with a gunner and two ammunition bearers in each. Planning at first assumed that in most situations only one automatic rifle team per squad would actually carry its automatic rifle. The automatic rifleman in the other team would just carry a rifle and for this purpose eight spare rifles were maintained at company headquarters. However once the AEF entered combat on a large scale automatic rifle sections routinely used every available automatic weapon.

**Small Arms:** All officers, first sergeants, buglers, and cooks are armed with pistols. All platoon sergeants, the team leaders and two PFC throwers in the hand bomber section, the two corporal team leaders in the rifle grenadier section, and the section leader and two squad leaders in the automatic rifle section all carry pistols or revolvers in addition to their rifles. Automatic riflemen carry pistols when also armed with the automatic rifle. All others carry rifles only.

**Sources:** US War Department, *The United States Army in the World War Vol. 1, Organization* p. 347; *Manual of the Chief of Platoon of Infantry* pp. 27-38; and Henry H. Burdick "Development of the Half-Platoon as an Elementary Unit" *Infantry Journal* April 1919.

### Appendix 2.3

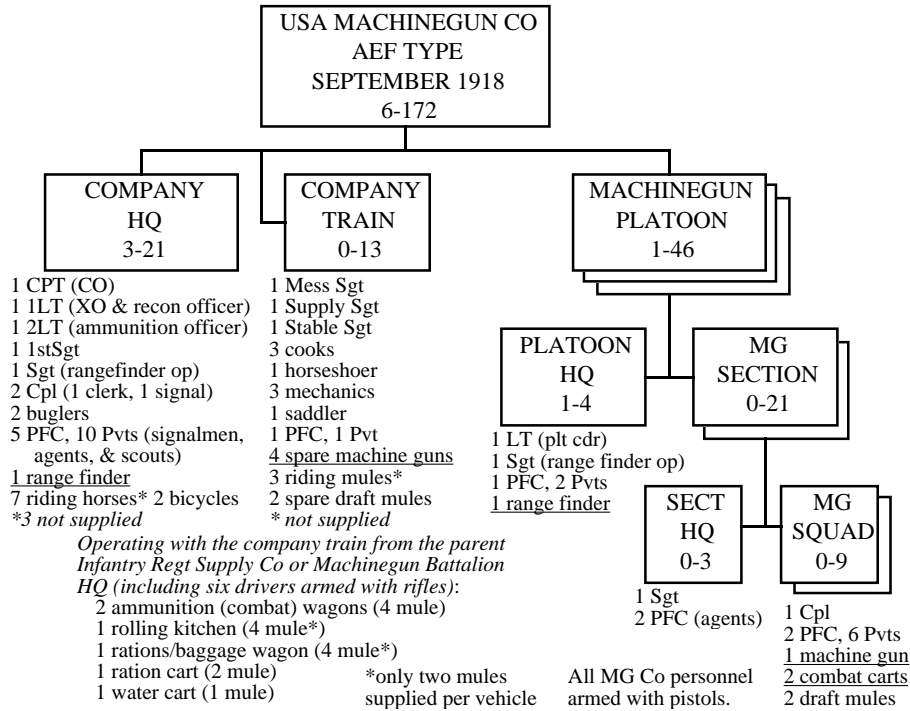

Notes:

Machinegun Sections: These are numbered 1 through 6, throughout the company.

Source: US War Department, *The United States Army in the World War Vol. 1, Organization*, p. 348.

## Appendix 2.4

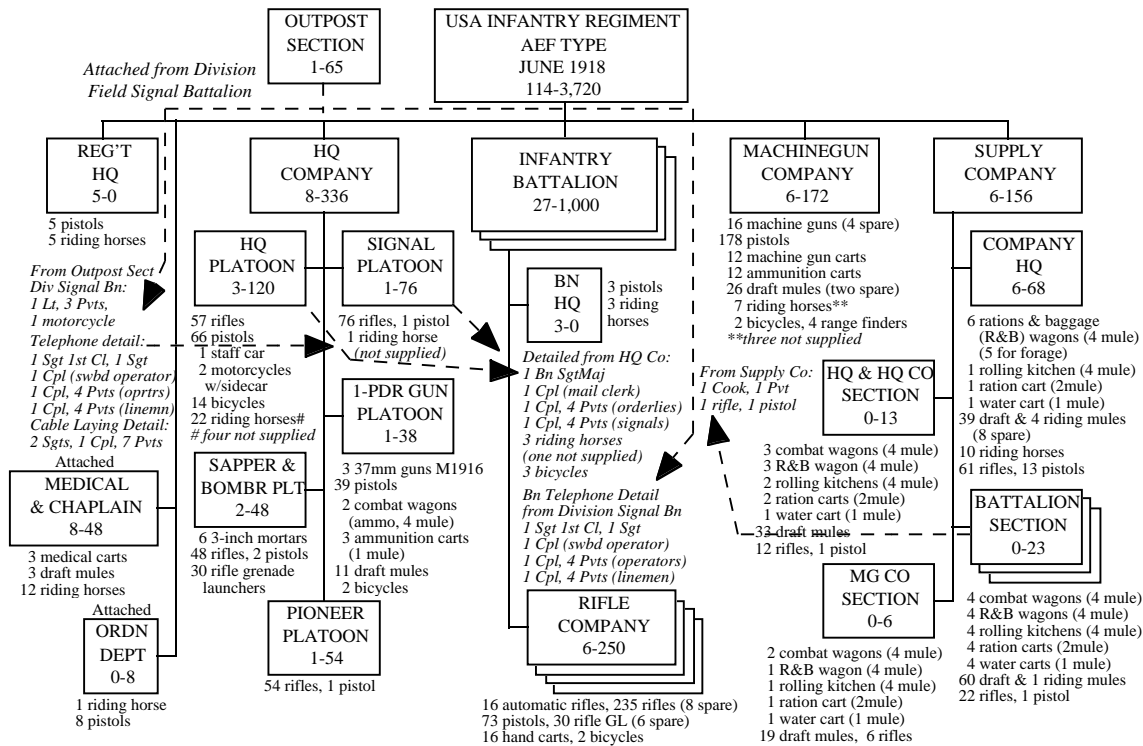

**Notes:**

**Regimental Headquarters:** One colonel, one lieutenant colonel, and three captains (personnel officer, operations and intelligence officer and regimental adjutant).

**Headquarters Company:**

**Headquarters Platoon:** The 1<sup>st</sup> Section (staff) had a captain (headquarters company commander), a lieutenant (intelligence officer), five sergeants major (one for personnel, one for the regiment and one for each battalion), the company first sergeant, two color sergeants, the company mess, supply and stable sergeants; two sergeants for personnel, three for intelligence and one in charge of mail; eight corporals (four regimental headquarters clerks, three battalion mail clerks and the headquarters company clerk), six cooks, a horseshoer, four mechanics, and six PFC (one chauffeur for the regimental headquarters' motorcar and five, of whom two have bicycles, for intelligence service). The 2<sup>nd</sup> Section (Orderlies) had one sergeant (mounted), three corporals (one per battalion), 25 privates and PFC (four per battalion) with two motorcycles, 12 bicycles, and a riding horse. The 3<sup>rd</sup> Section was the Band (with a second lieutenant and 49 band members).

**Signal Platoon:** Commanded by a second lieutenant (mounted), its 1<sup>st</sup> (Telephone) Section had three sergeants, eight corporals and 40 privates/PFC. The 2<sup>nd</sup> Section with one sergeant, one corporal and eight privates/PFC supported regimental headquarters. The 3<sup>rd</sup> Section of three corporals and 12 privates/PFC provided detachments for the three battalion headquarters.

**Sappers and Bombers Platoon:** Commanded by a first lieutenant assisted by a second lieutenant it had one sapper squad (a corporal and eight privates) and a bomber section with three sergeants, six corporals and 40 privates. This section could operate either six 3-inch Stokes mortars or 30 rifle grenade launchers.

**One-Pounder Gun Platoon:** Had a first lieutenant (with a bicycle), three privates/PFC (liaison agents, one with a bicycle), two wagon drivers, two escort (ammunition) wagons, and three gun squads with a one-pounder (37mm) gun, a one-mule cart, a sergeant, a corporal, and nine privates/PFC in each.

**Pioneer Platoon:** A second lieutenant, two sergeants and four squads with a corporal and 12 privates/PFC in each.

**Supply Company:**

**Company Headquarters:** Included the company commander (a captain) and, at first, three lieutenants. The number of lieutenants later increased to five since this permitted a lieutenant to act as supply officer for each battalion. Additionally, there were three regimental supply sergeants (acting as supply sergeants for the three battalions), a first sergeant, a mess sergeant, a stable sergeant, four supply sergeants (one for the company and three for the regiment), a sergeant wagon-master, a company clerk (corporal), three cooks, five horse-shoers, two saddlers, five "mechanics" (three worked as cobblers), nine wagon drivers and a labor or fatigue section with a sergeant, a corporal and 30 privates (10 PFC).

**Three Battalion Sections (each):** One corporal (assistant wagon-master), 20 wagon drivers and a cook and a cook's helper (private) to staff the supported battalion's officers' mess.

**Headquarters and Headquarters Company Section:** Had 11 wagon drivers, a cook and a cook's helper (private). The cook and cook's helper were to staff a regimental officer's mess. One rations and baggage wagon (with driver) was to carry regimental headquarters baggage. The other vehicles were for the headquarters company.

**Small Arms:** In the headquarters and supply companies officers, sergeants major, regimental supply sergeants, first sergeants, color sergeants, cooks, band members, and one-pounder gun platoon members carried pistols. All others carried rifles.

**Attached Medical and Chaplain:** Included one senior medical officer (a major), six junior medical officers (lieutenants or captains), a chaplain, a sergeant first class, four sergeants, and 43 privates. Internal organization was not officially prescribed but the detachment would normally operate as a regimental section and three battalion sections. A battalion section would have one or two medical officers, a sergeant and a dozen or so privates. One private drove the section's medical carts, eight served with the rifle companies and the rest were with the aid station. The regimental medical section would, among other things, provide two medics for the regimental machinegun company.

**Attached Ordnance:** An ordnance sergeant (mounted), a corporal, and six privates (two PFC) who maintained weapons. They operated with the supply company.

**Attached Outpost Section, Outpost Company, Division Field Signal Battalion:** Provided a 13-man telephone detail to the regimental headquarters and each battalion headquarters. Also provided a 10-man cable laying detail to the regimental headquarters. This was in addition to the 46-man telephone section in the regiment's own signal platoon.

**Source:** US War Department, *The United States Army in the World War Vol. 1, Organization*, pp. 344-346 and 362-63.

### Appendix 2.5

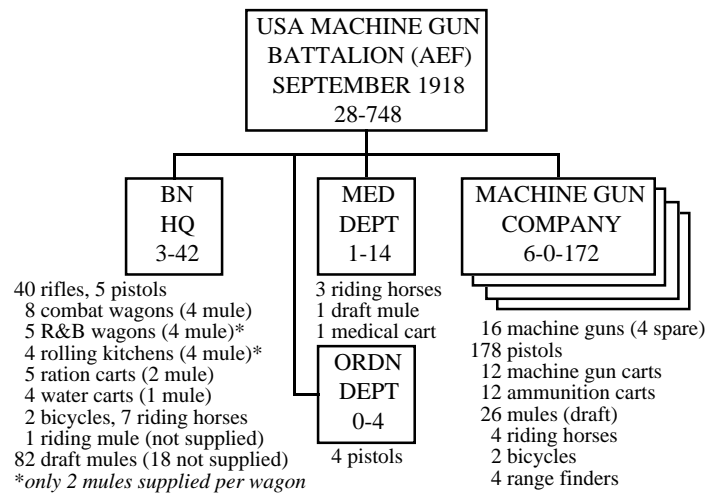

Notes:

**Battalion headquarters:** Includes the battalion commander (a major), an adjutant and a supply officer (both lieutenants), two sergeants major (one serving as battalion supply sergeant), a stable sergeant, a personnel sergeant, a corporal and six privates (agents and signalmen), a cook, two mounted orderlies, 26 drivers (for the wagons and carts), and two spare men. The officers and the two sergeants major carried pistols. All others had rifles.

**Ordnance Department:** A normal attachment of sergeant and three privates (mechanics/armorers).

**Medical Department:** An officer (mounted), a sergeant first class (mounted), a sergeant and 12 PFC (one mounted).

**Source:** US War Department, *The United States Army in the World War Vol. 1, Organization*, p. 350.

## Appendix 2.6

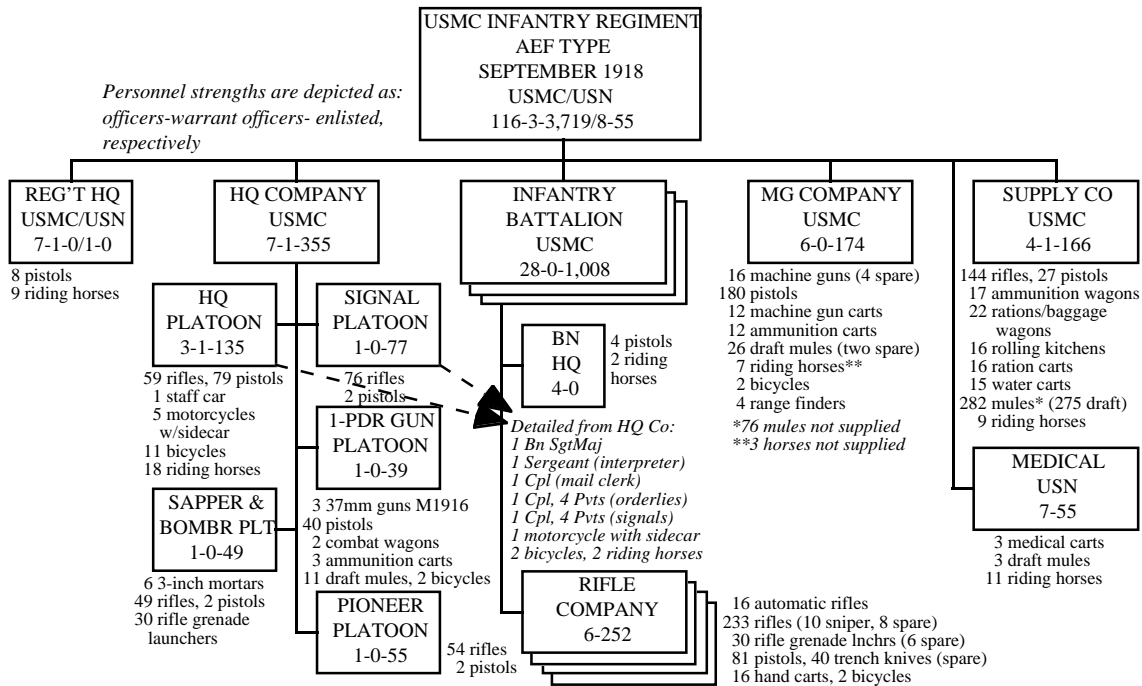

### Notes:

A Marine AEF regiment generally resembled its Army counterpart but differed in certain details some of which are noted below. Throughout the regiment, horseshoers, mechanics, saddlers, and wagon drivers ranked as technical corporals. Cooks only ranked as privates and did not occupy a special pay grade as they did in the Army. Color, mess, stable, and company supply sergeants were ranked as sergeants only without special status.

**Regimental Headquarters:** A colonel, a lieutenant colonel, two majors (regimental adjutant and operations and intelligence officer), a captain (personnel officer), a first lieutenant (assistant operations and intelligence officer), a second lieutenant (a late addition; his job description is unreadable in the original documents; he may have been a chemical or ordnance officer), a warrant officer (paymaster clerk assistant to the personnel officer), and the chaplain.

**Headquarters Platoon, Headquarters Company:** It included a regimental pay section with a captain (paymaster), a warrant officer (paymaster clerk), four paymaster sergeants, eight sergeants and four corporals. The lieutenant intelligence officer moved to the regimental headquarters but three sergeant interpreters were added for assignment to the battalions. The chauffeur of the regimental motorcar ranked as a technical corporal. There were only three, not five intelligence privates.

**Signal, Sapper and Bomber, One-Pounder Gun and Pioneer Platoons:** In addition to the same complement authorized by the Army, each of these platoons received a gunnery sergeant to act as platoon sergeant. Nine of the 14 privates first class in the telephone section of the signal platoon ranked as technical corporals.

**Supply Company:** The company included a warrant officer (quartermaster clerk) and six quartermaster sergeants (in lieu of the three regimental supply sergeants in Army regiments; one quartermaster sergeant was in each battalion section). Apparently only two sergeants were assigned to regimental supply duties (not three as in Army regiments).

**Ordnance Section:** In a Marine regiment they were part of the supply company, not an attachment. The Marine section included a gunnery sergeant, a corporal, two technical corporals, and four privates.

**Battalion Headquarters:** Each one includes a second lieutenant gas officer.

**Rifle Companies:** Two gas sergeants augmented company headquarters. Two of the company mechanics were specially trained and equipped as snipers. A sergeant team and section leader replaced the PFC team leader in each hand bomber and rifle grenadier section. Two riflemen in the rifle section (one ranking as a technical corporal) were trained and equipped as snipers (like the two mechanics in company headquarters). Gunnery sergeants served as platoon sergeants.

**Machinegun Company:** Two gas sergeants augmented company headquarters. Each platoon headquarters received a platoon sergeant (gunnery sergeant) in lieu of one private but retained its sergeant platoon guide and range finder.

**Attached (US Navy) Medical:** Similar to but slightly stronger than its Army counterpart, it included four men (probably one per battalion or regimental section) specially trained in podiatry.

**Source:** Tables of Organization Numbers 1 (infantry regiment) dated 1 August 1918 (but with handwritten notes of changes made in September) and 5 (rifle company) dated 1 September 1918. Copies of both are at the Marine Corps Historical Center at the Washington Navy Yard, Washington DC.



## Appendix 2.7

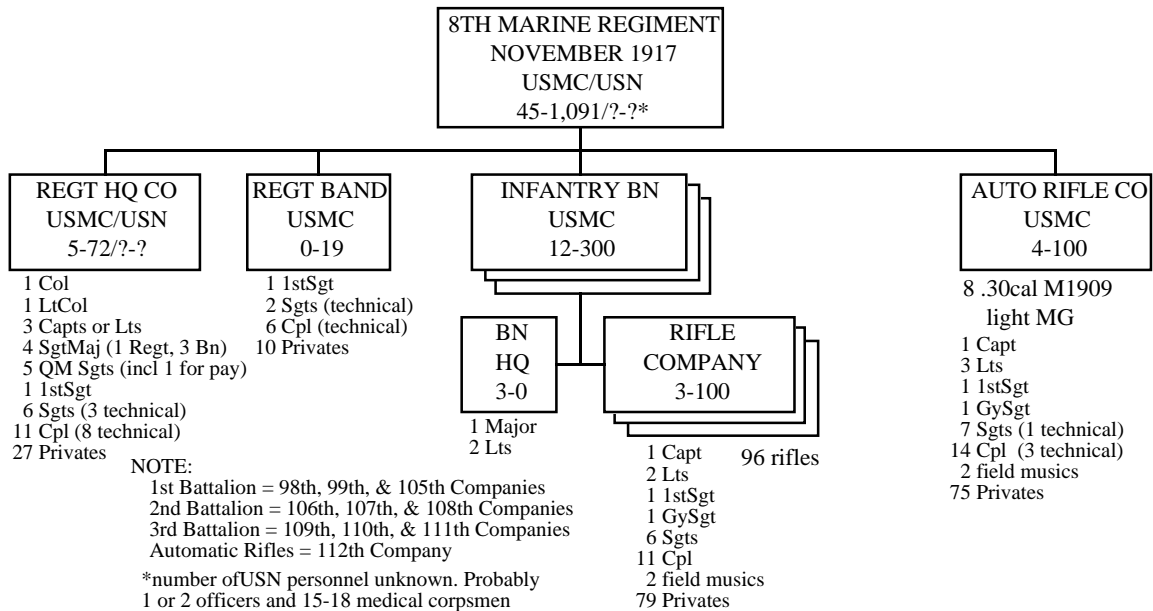

**NOTE:**

1st Battalion = 98th, 99th, & 105th Companies  
 2nd Battalion = 106th, 107th, & 108th Companies  
 3rd Battalion = 109th, 110th, & 111th Companies  
 Automatic Rifles = 112th Company  
 \*number of USN personnel unknown. Probably  
 1 or 2 officers and 15-18 medical corpsmen

**Notes:**

**Regimental Headquarters:** It would include an adjutant, a quartermaster and a paymaster, a sergeant major and a quartermaster sergeant for the regimental headquarters and each battalion and another quartermaster sergeant to assist the paymaster.

**Rifle Companies:** The company gunnery sergeant may have functioned as his parent company's supply and ordnance sergeant though he might also have commanded a platoon when the company organized for combat. One sergeant per company would probably have served as mess sergeant and another as supply sergeant. The rest would have been platoon or section leaders or guides. A full-strength company could form ten eight-man squads, led by corporals. Another per company would be company clerk. The privates would have included two cooks and several messengers or signalmen. All company members would have carried rifles except the officers, the first sergeant, gunnery sergeant, and the field musics (buglers).

**Automatic Rifle Company:** Most of the remarks pertaining to the rifle companies would apply here as well. Unlike a rifle company, the automatic rifle company would have included a reconnaissance officer. One sergeant would have served as stable sergeant for the animals needed to move the company's machineguns and their ammunition. There were most likely eight machinegun squads (led by corporals) forming two platoons with four squads, two sergeants, a corporal (for signals), and a corporal (technical) range finder operator in each. A sergeant (technical) would operate the company range finder

**Source:** Record Group (RG) 127 Entry 18 Box 345 Ellsdran File 2385-30 Memo for the Quartermaster 8 November 1917 (description of the Eighth Regiment) plus an undated strength summary, US National Archives Washington DC.

## APPENDIX 3

### Appendix 3.1

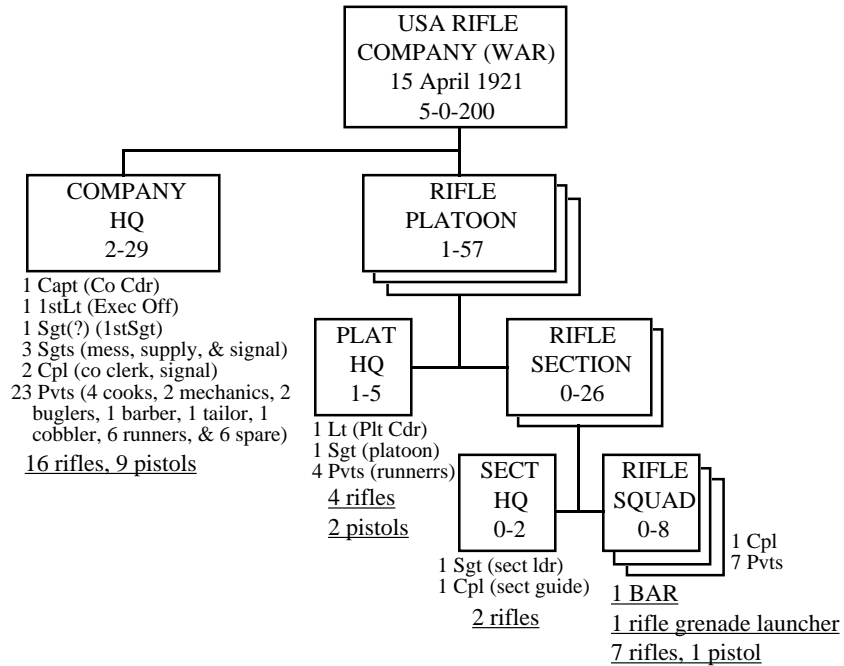

**Notes:**

**Company Headquarters:** Tactically splits into a captain's group (with the company commander, first sergeant, signal sergeant, signal corporal, two buglers, and six runners) and an administrative group (all other headquarters personnel).

**Small Arms:** Officers, the first sergeant, platoon sergeants, buglers, cooks, and automatic riflemen armed with pistols. Automatic riflemen also carry the Browning Automatic Rifle (BAR). All others armed with rifles.

**Enlisted Ranks:** The actual rank of the company first sergeant is not specified in the tables. That is because the first sergeant was the most senior non-commissioned officer in the company (regardless of his substantive rank). Since an infantry battalion sergeant major ranked only as a staff sergeant a rifle company first sergeant would have ranked no higher than that. In a rifle company up to 53 privates in the company could rank as PFC. Two cooks ranked as T-4 technicians (equivalent to sergeant). The other two cooks were T-5 (corporal equivalents). The mechanics and automatic riflemen were T-6 (same as PFC).

**Source:** War Department Table 28W, "Rifle Company, Infantry Regiment (War Strength)" April 15, 1921.

### Appendix 3.2

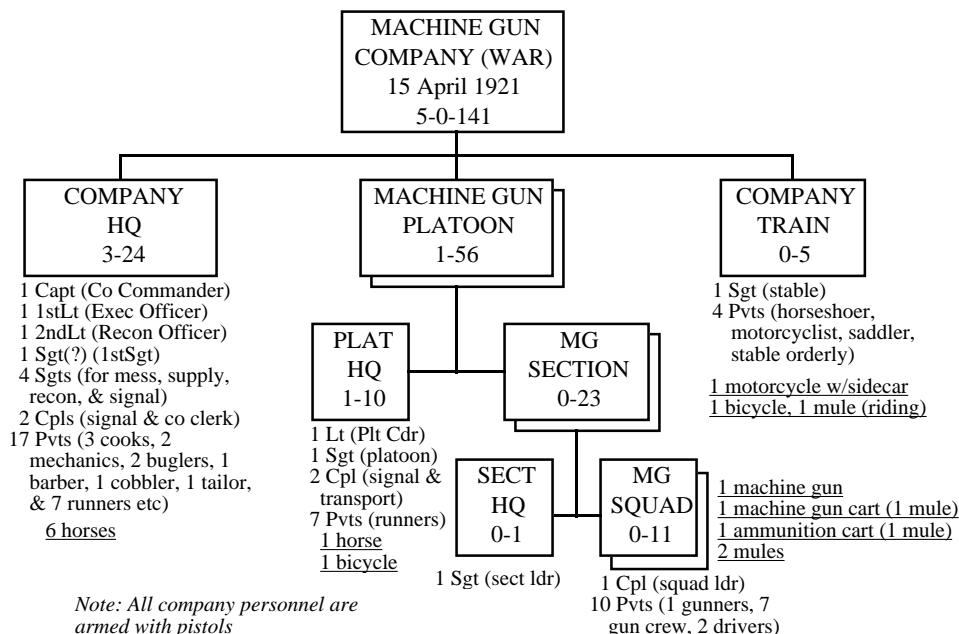

**Notes:**

**Transportation:** Riding horses were provided for all officers, the first sergeant and the two buglers. The stable sergeant rode a mule (sufficient to enable him to keep up with combat or field train vehicles). The bicycle belonging to the company train was actually used by one of the runners in company headquarters. One runner in each platoon headquarters was also equipped with a bicycle.

**Enlisted Ranks:** The actual rank of the company first sergeant is not specified in the tables. See the comments under Appendix 3.1 above. In a machinegun company up to 35 privates in the company could rank as PFC. One cook and the horse-shoer (farrier) ranked as T-4 technicians (equivalent to sergeant). The other two cooks and the saddler were T-5 (corporal equivalents). The mechanics, the motorcyclists and three of the machine-gunners were T-6.

**Source:** War Department Table 29W, "Machinegun Company, Infantry Regiment (War Strength)" April 15, 1921.

### Appendix 3.3

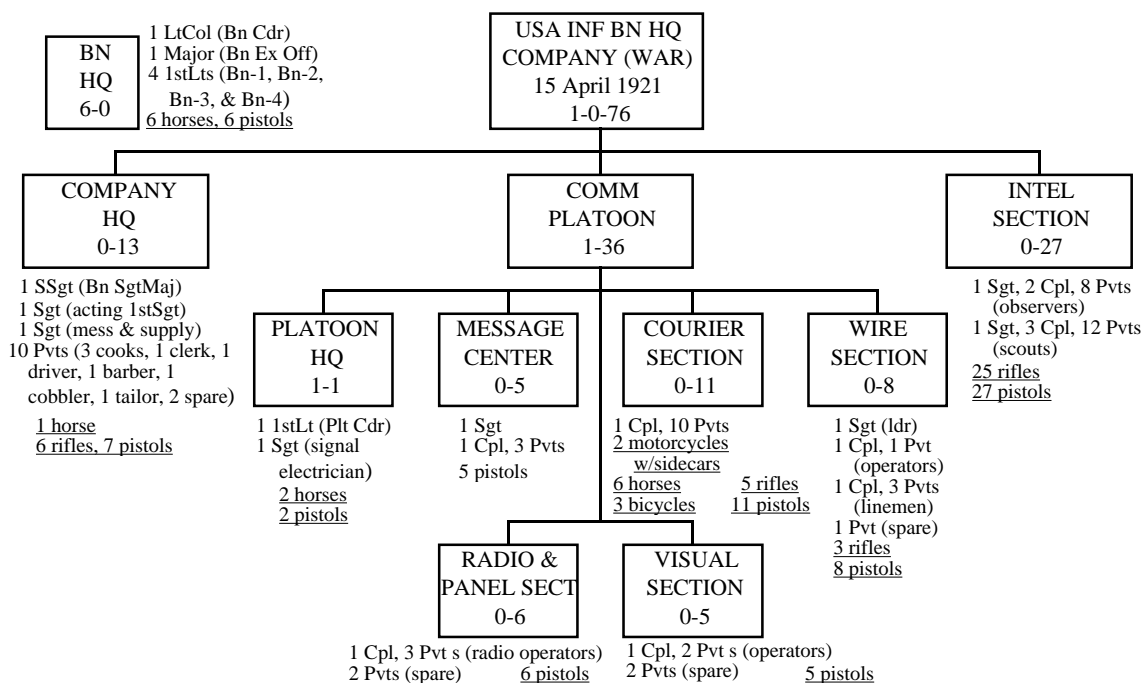

**Notes:**

**Small Arms:** All personnel armed with pistols except the barber, the clerk, one (T-5) cook, the tailor and two spare privates in the company headquarters. In the communication platoon, three linemen (privates) in the wire section and five messengers (those equipped with motorcycles or bicycles) in the courier section have rifles in addition to their pistols. All personnel in the intelligence section, except for the two sergeants also carry rifles in addition to their pistols.

**Transportation:** All officers, the staff sergeant (acting as sergeant major), the communication platoon sergeant and signal electrician, the courier section leader and five messengers. Bicycles are supplied for three messengers and motorcycles for two.

**Signal Equipment (Communication Platoon):** One radio set to communicate with regimental headquarters, an adjacent battalion or supporting artillery; one hand-packed reel cart, five miles of phone wire; two four-line switchboards; four EE-4 telephones (for official use) and one EE-5 telephone for service maintenance.

**Enlisted Ranks:** Up to 24 privates in the company could rank as PFC. The company clerk and two cooks ranked as T-4 technicians (equivalent to sergeant). One cook and the driver for the battalion commander's automobile (when one was available) were T-5 (corporal equivalents). Three scouts, four observers, and one switchboard operator (in the wire section) were T-6.

**Source:** War Department Table 29W, "Headquarters and Headquarters Company, Infantry Battalion (War Strength)" April 15, 1921.

### Appendix 3.4

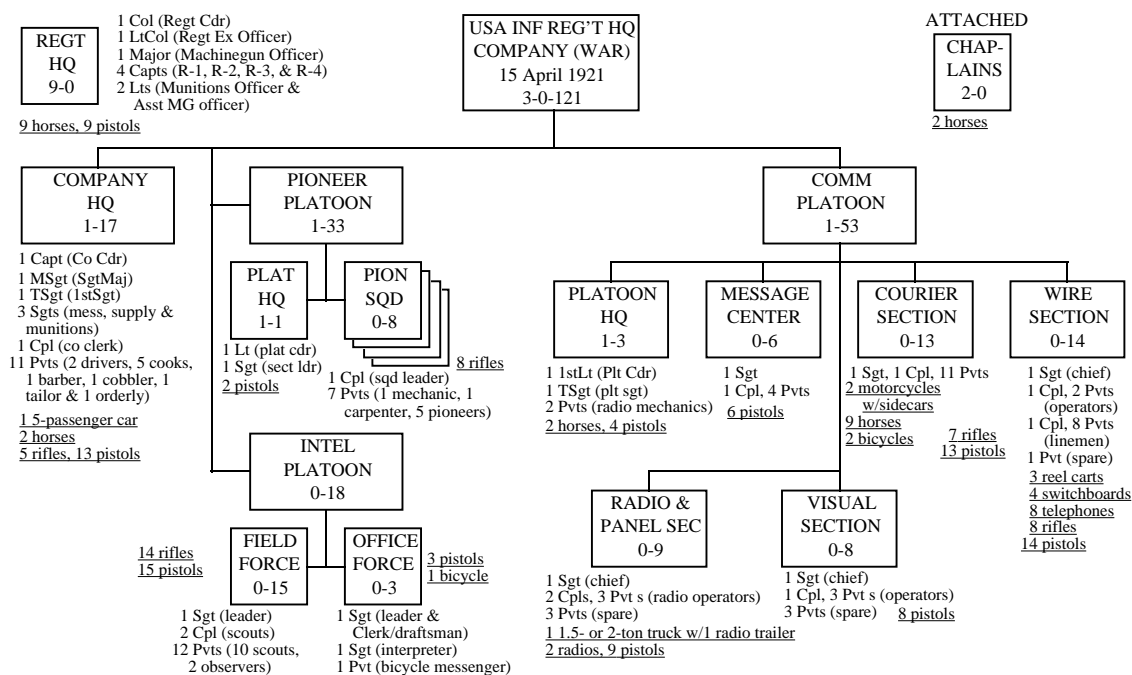

**Notes:**

**Small Arms:** All personnel armed with pistols except that the barber, the company clerk (corporal), two (T-5) cooks and the tailor in the company headquarters and everyone in the pioneer platoon (except the platoon commander and platoon sergeant) carry rifles. All members of the intelligence platoon “field force” except the sergeant section leader) and the seven (horse) mounted messengers (privates) in the courier section and the eight telephone linemen in the wire section carry rifles in addition to their pistols. The chaplains were officially unarmed.

**Transportation:** All officers, the master sergeant (sergeant major), the communication platoon sergeant and the courier section chief, assistant chief and seven messengers had riding horses. Bicycles are supplied for two messengers in the courier section and one in the office force of the intelligence platoon. Two messengers had motorcycles.

**Signal Equipment (Communication Platoon):** Two radio sets, one (usually an SCR-130, carried in a truck and trailer) to communicate with higher and adjacent units and one (usually an SCR-79A) to communicate with subordinate units; three hand-packed reel carts, 15 miles of phone wire; two four-line and two 12-line switchboards; seven EE-4 telephones (for official use) and four EE-5 telephones for service maintenance.

**Enlisted Ranks:** Up to 40 privates in the company could rank as PFC. The carpenters and mechanics in the pioneer platoon and three cooks in company headquarters ranked as T-4 technicians (equivalent to sergeant). One T-4 cook and the orderly in company headquarters were for the headquarters’ officers’ mess. Two cooks and the two drivers for the regimental automobile were T-5 (corporal equivalents). Two observers, the two radio mechanics, the two motorcycle messengers, and the switchboard, radio, and visual operators were T-6.

**Source:** War Department Table 24W, “Headquarters and Headquarters Company, Infantry Regiment (War Strength)” April 15, 1921.

### Appendix 3.5

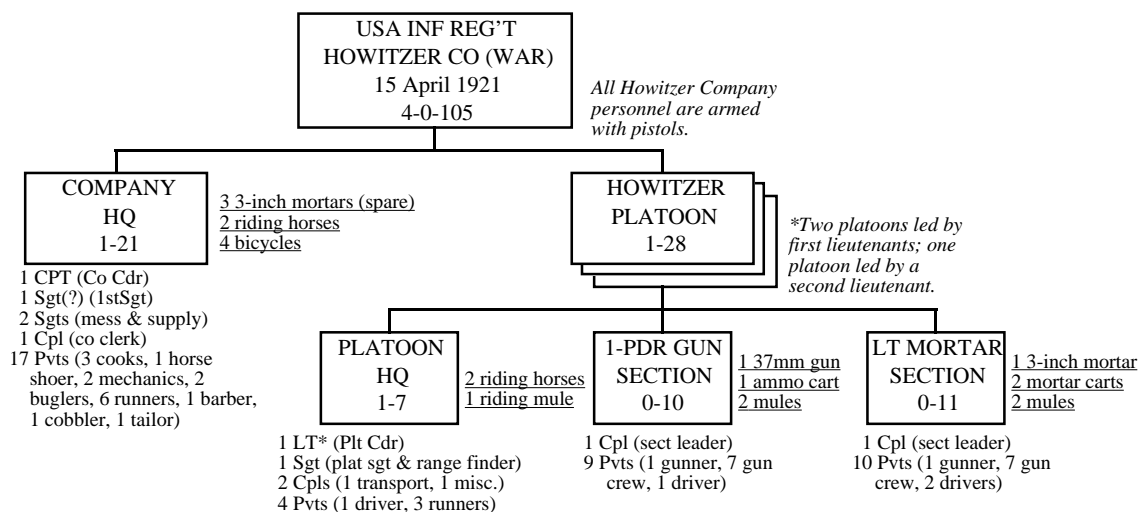

**Notes:**

Why the company headquarters included two motor vehicle drivers (chauffeurs, rated T-6) but no vehicles is unclear. Possibly there were plans for a light truck.

**Transportation:** All officers, the first sergeant and the three platoon sergeants had riding horses. The three platoon transport corporals rode mules. Four company runners had bicycles. Service company vehicles would transport the three spare 3-inch mortars held by company headquarters. One mortar cart carried the mortar and 24 rounds of ammunition while the other carried 48 rounds. Each 3-inch mortar shell (with its packing material) weighed a little less than 15 pounds. The ammunition cart for the one-pounder or 37mm gun carried about 144 rounds of 37mm.

**Enlisted Ranks:** Up to 26 privates in the company could rank as PFC. One cook and the horse-shoer ranked as T-4 technicians (equivalent to sergeant). The other two cooks (actually titled assistant cooks) were T-5 (corporal equivalents). The mortar and 37mm gunners and the two chauffeurs were T-6.

**Source:** War Department Table 30W, "Howitzer Company, Infantry Regiment (War Strength)" April 15, 1921.

### Appendix 3.6

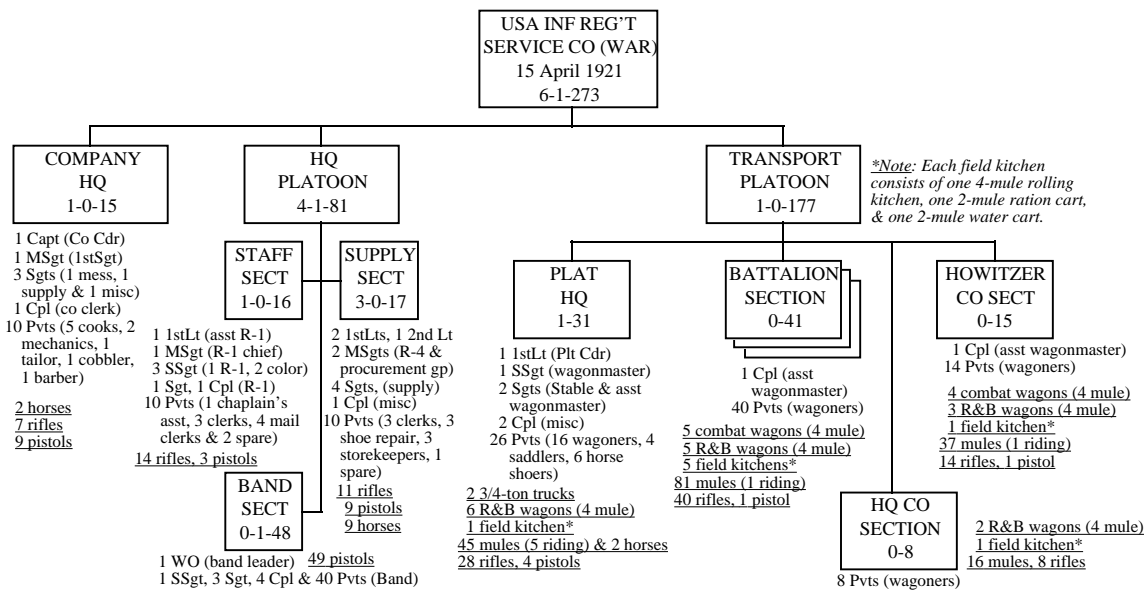

**Notes:**

**Attachment:** When its parent regiment is not serving as part of an infantry division the service company can an attachment of six privates (three of them PFC) driving three four-mule rations and baggage (R&B) wagons loaded with entrenching tools and other engineer equipment. When the regiment is part of a division these vehicles would come (when needed) from the division engineer regiment.

**Small Arms:** Distribution of these was not described in detail in the original 1921 tables. However, based on normal practice and the information appearing on later tables small arms distribution can still be described fairly accurately. In the service company headquarters the three junior (assistant or T-5) cooks, the two mechanics, the barber and the tailor would have been rifle armed. All others would have carried pistols. In the headquarters platoon, staff section the first lieutenant, master sergeant and staff sergeant working for the R-1 carried pistols. All others had rifles. In the supply section the officers, master sergeants and sergeants carried pistols and the lower ranks had rifles. In the transport platoon, all personnel carried rifles except the lieutenant, staff sergeant, sergeants, and the corporal section leaders.

**Transportation:** The company commander, first sergeant, transport platoon commander and platoon sergeant and the officers, master sergeants and sergeants in the supply section all have riding horses. Riding mules go to the sergeants and corporals in the transport platoon headquarters and to transport platoon section leaders. Four-mule combat or R&B wagons or rolling kitchens have two drivers each. Eight mules in the transport platoon headquarters are spare. In each battalion section one R&B wagon and one field kitchen (one rolling kitchen plus ration and water carts) support each company in the battalion. In addition, each rifle company gets a combat wagon and the machinegun company gets two. In the howitzer company section two of the R&B wagons carry the howitzer company's spare mortars. Four of the R&B wagons in transport platoon headquarters carried forage for the company's mules. The two 3/4-ton trucks were for general utility use. The normal payload of a combat or R&B wagon was 2,500 pounds though in some circumstances it might be increased to as much as 4,500 pounds. Horse drawn vehicles were expected to cover 30 miles a day. Trucks were expected to cover 100 to 140 miles or more per day.

**Enlisted Ranks:** Up to 67 of the privates can rank as PFC. One clerk each in the staff and supply sections ranks as T-3 (staff sergeant equivalent). The wheelwright (supply section), horse-shoers (transport platoon headquarters, two cooks (in company headquarters) and a clerk each in the staff and supply sections rank as T-4 technicians (sergeant equivalent). Three cooks, a clerk each in the staff and supply sections, the three shoe repair machine operators in the supply section and the four saddlers in the transport platoon headquarters rank as T-5 technicians (corporal equivalent). The two mechanics in company headquarters and 64 wagoners (drivers) rank as T-6. The 40 privates in the band include four T-2 (technical sergeant equivalent), six T-3, six T-4, 15 T-5 and 9 T-6 musicians.

**Source:** War Department Table 25W, "Service Company, Infantry Regiment (War Strength)" April 15, 1921.

### Appendix 3.7

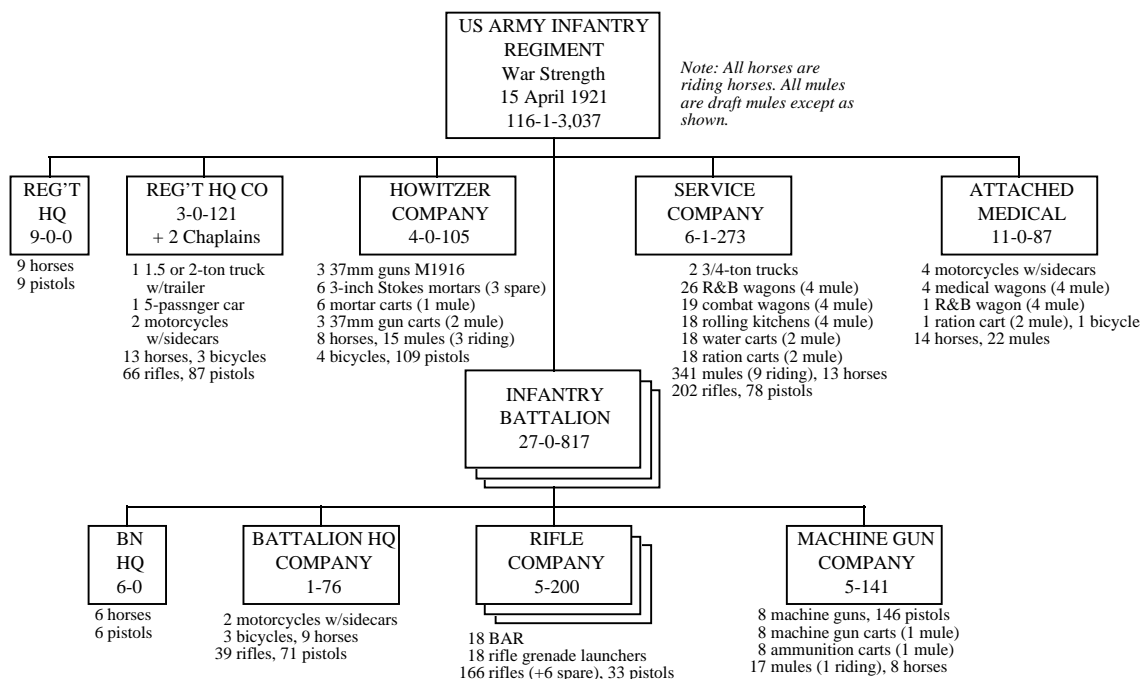

**Notes:**

**Regimental Medical Detachment:** This was technically not a part of the regiment because it was permanently “attached” from the Army Medical Department. No internal structure was officially specified but the detachment would normally organize itself approximately as follows:

**Regimental Medical Section:** One major (regimental surgeon and detachment commander), one other medical officer, two dental officers and a veterinary officer. All these officers could be captains or first lieutenants and all but one of them had riding horses. There would also be a technical sergeant (detachment first sergeant, who would also have a horse), three sergeants (one veterinary with a horse), a corporal, three medical technicians (a T-2, a T-3 and a T-6), two veterinary technicians (a T-4 and a T-6), two dental technicians (both T-6), two cooks (a T-4 and a T-5), two wagoners or drivers (T-6), a mechanic (T-6) and about 10 other privates first class (including three wagoners or drivers, a motorcycle driver, one veterinary man and at least one messenger). Two privates/technicians are mounted. Equipment includes an R&B wagon, a medical wagon, a water cart, a motorcycle with sidecar, a bicycle, 11 horses and 10 mules.

**Three Battalion Medical Sections (each):** Two medical officers (one mounted), one staff sergeant (mounted), one sergeant, one corporal, four medical technicians (one T-4 and three T-6) and 13 other privates first class (including two wagoners/drivers and a motorcycle driver), Enlisted personnel include two aidmen (medics) for each rifle or machinegun company and probably two or three two-man stretcher teams. Equipment included a medical wagon, four mules and one horse.

**Road Space Requirements:** The regiment (including its combat and field trains) used 3,930 yards or nearly 2.25 miles of road. Of this the troops used up 1,815 yards, the combat trains 1,170 yards and the field trains 945 yards.

**Source:** War Department Table 23W, “Infantry Regiment (Consolidated Table) (War Strength)” April 15, 1921.



Appendix 3.8

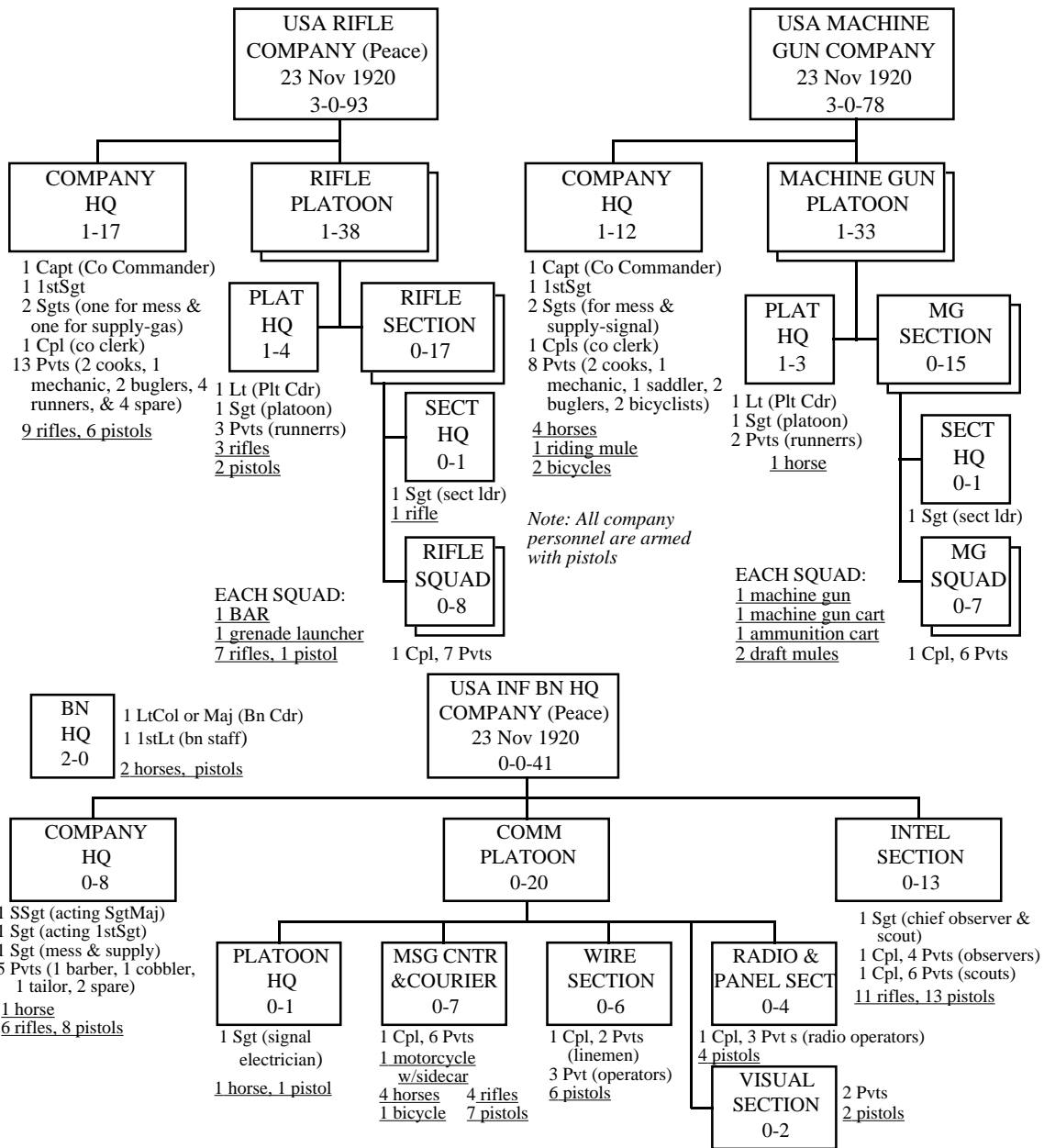

Notes:

**Small Arms:** The rules under which rifles and pistols were distributed were generally the same as in wartime.

**Enlisted Ranks:** Up to 11 privates per headquarters company, 22 per rifle company and 16 per machinegun company could be PFC. One cook per company is a T-4 technician. The other is a T-5. All company mechanics, two BAR men per rifle company, four gunners per machinegun company, one observer and two scouts in the intelligence section, one operator each in the wire and radio sections, and the battalion motorcyclist are T-6. The message center and courier section of the battalion communication platoon included a pigeon man.

**Transportation:** In the machinegun and headquarters companies, all officers, the battalion sergeant major, the machinegun company first sergeant, the machinegun company buglers, the communication platoon sergeant, and the section leader and three messengers from the message center and courier section had riding horses.

**Source:** War Department Tables 27P, "Headquarters and Headquarters Company, Infantry Battalion (Peace Strength);" 28P "Rifle Company, Infantry Battalion (Peace Strength)" and 29P "Machinegun Company, Infantry Battalion (Peace Strength)" November 23, 1920.

### Appendix 3.9

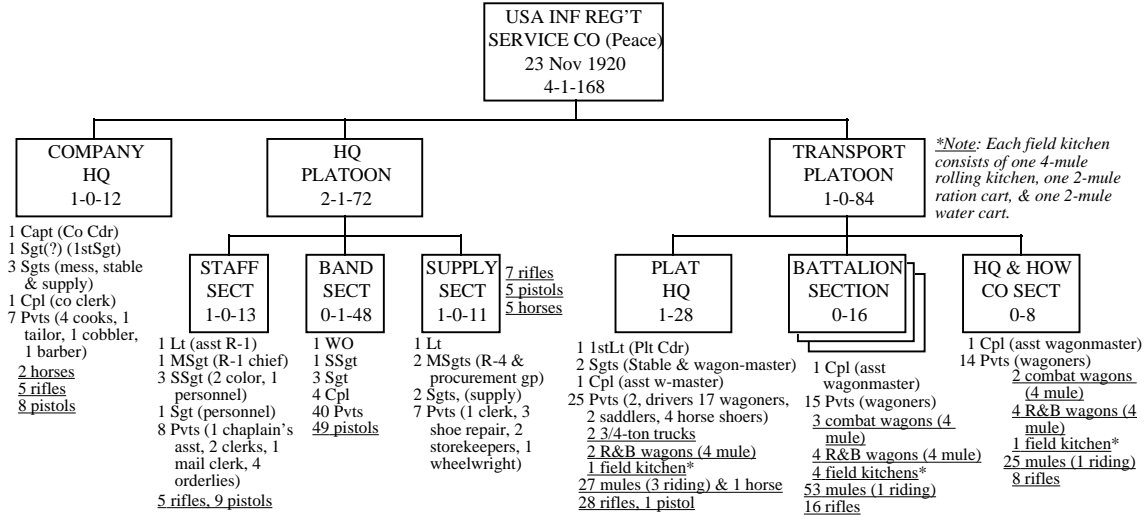
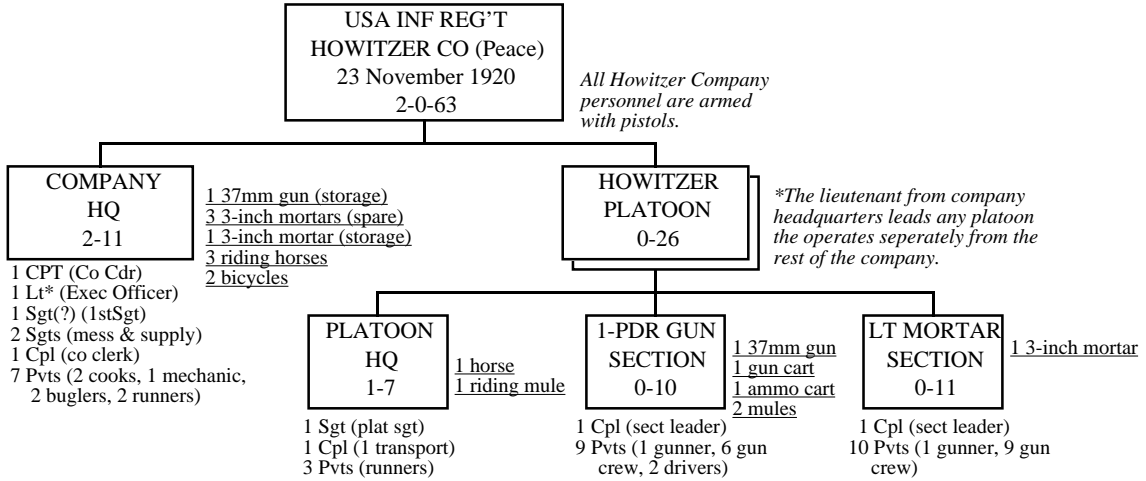
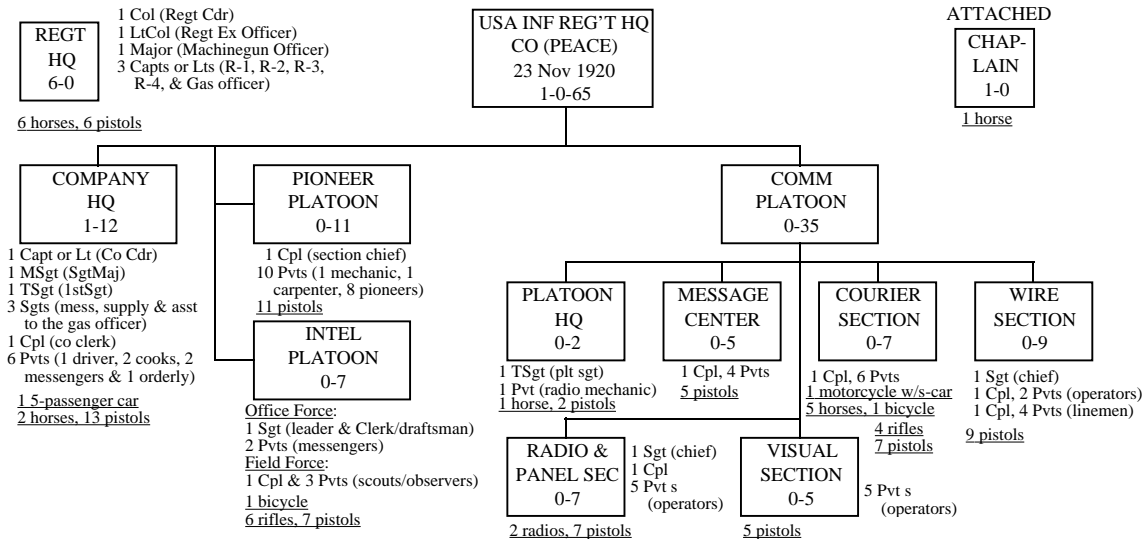

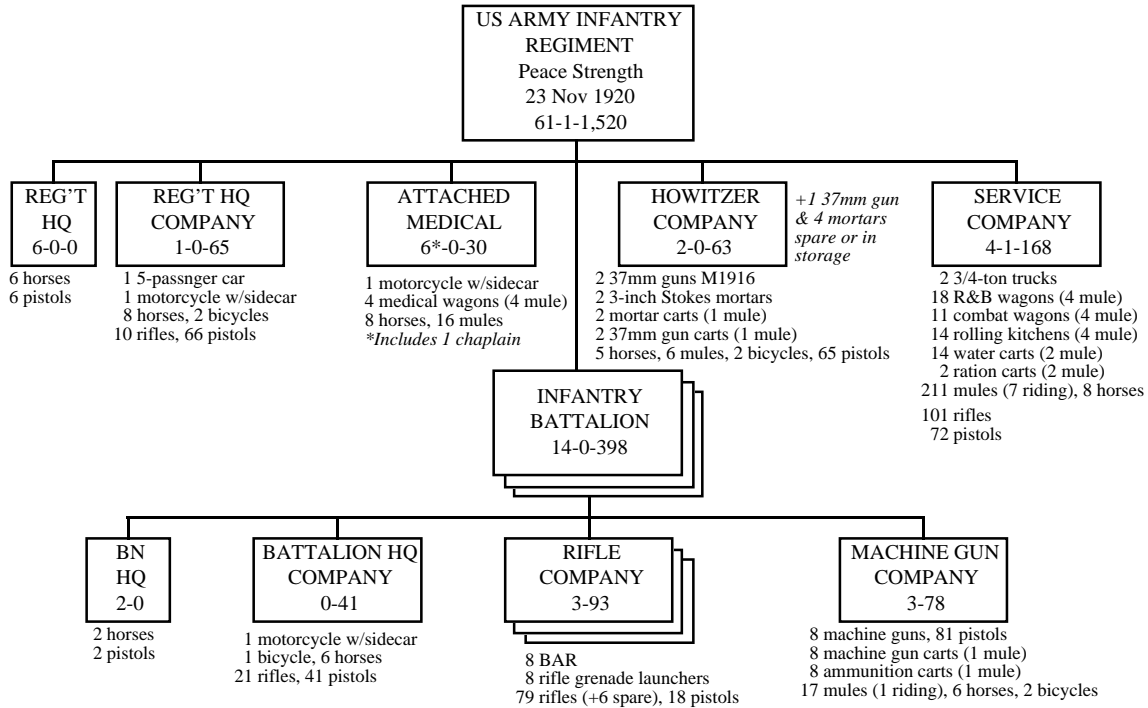

**Notes:**

Medical Detachment: Five medical officers, one staff sergeant, three sergeants, one corporal, eight PFC and 17 privates (including two T-4 and 10 T-6).

Source: War Department Tables 23P, "Infantry Regiment (Consolidated Table) (Peace Strength);" 24P, "Headquarters and Headquarters Company, Infantry Regiment (Peace Strength);" 25P, "Service Company, Infantry Regiment (Peace Strength);" and 30P "Howitzer Company, Infantry Regiment (Peace Strength)" November 23, 1920.

Appendix 3.10

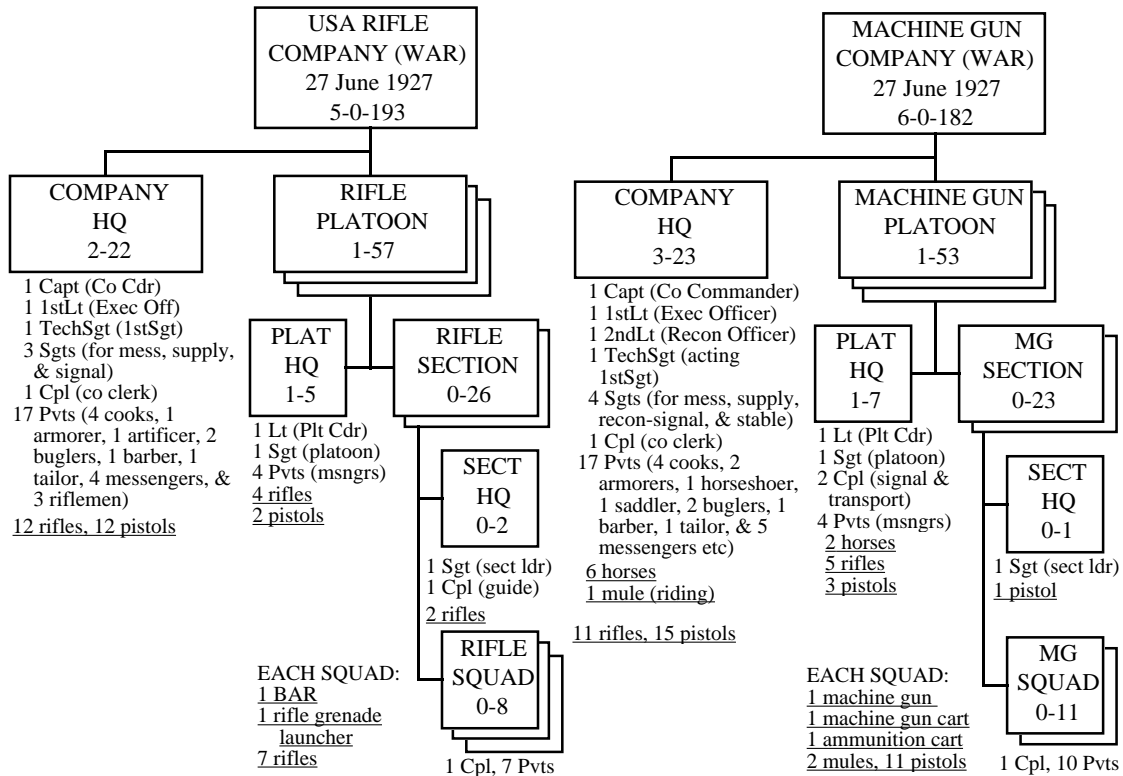

Notes:

**Small Arms:** In the rifle company, pistols are issued to all officers, the first sergeant, the mess and supply sergeants, the three rifle platoon sergeants, the two buglers and four cooks. All other personnel (except the automatic riflemen) carry rifles. In the machinegun company, the company reconnaissance and signal sergeant, the two armorers, the saddler, tailor, barber, the three corporal platoon agents and all company and platoon messengers carry rifles.

**Transportation:** In the machinegun company all officers, the first sergeant, the three platoon sergeants and the two buglers have riding horses. The stable sergeant has a riding mule.

**Enlisted Ranks:** There can be up to 47 privates first class (PFC) in the rifle company and up to 46 in the machinegun company. The senior armorer in the machinegun company is a T-3 technician. In the rifle company he is a T-4. The machinegun company has a junior armorer (T-4) but the rifle company instead has an artificer (T-6). The horseshoer in the machinegun company is a T-4 and the saddler is T-5. Two cooks in each company are T-4 and two are T-5. Six automatic riflemen in the rifle company and 12 gunners in the machinegun company are T-6.

**Source:** War Department Tables 28W "Rifle Company, Infantry Battalion" and 29W "Machinegun Company, Infantry Battalion" June 27, 1927.

### Appendix 3.11

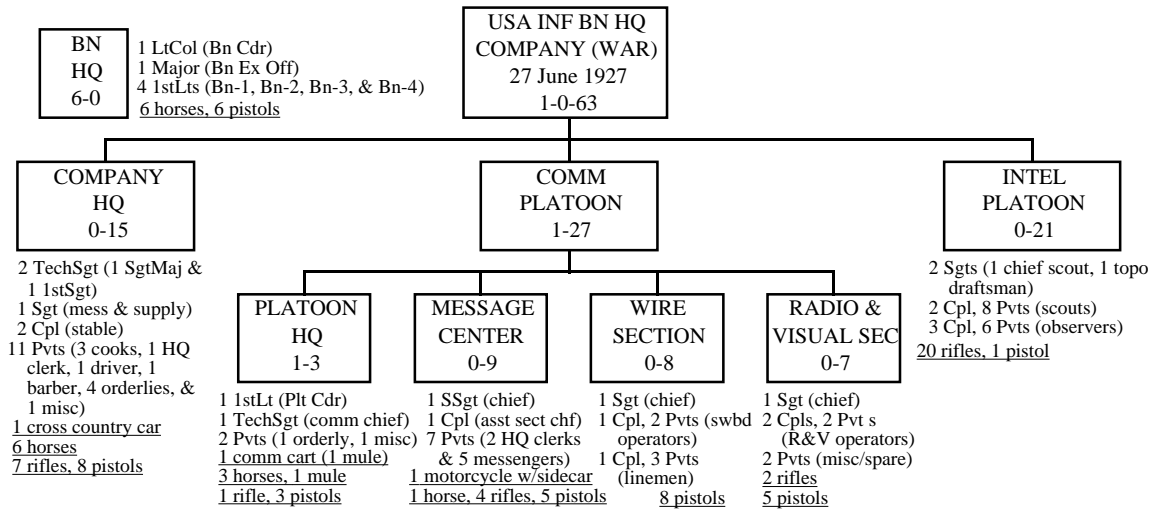

**Notes:**

**Small Arms:** All personnel in the intelligence platoon carry rifles except the draftsmen. All personnel in the communication platoon except the two spare privates in the radio section, four messengers in the message center section (the motorcycle messenger carries a pistol) and the orderly in platoon headquarters who carry rifles. In the company headquarters the orderlies, the miscellaneous private, the barber and the HQ clerk carry the only rifles.

**Transportation:** The officers, the sergeant major, the first sergeant, the communication chief, the orderlies and one messenger have riding horses. The miscellaneous private in the communication platoon headquarters drives the cart.

**Enlisted Ranks:** Company includes 17 PFC. Two cooks (one for the battalion officers' mess) are T-4. One cook and the HQ clerk is T-5. The automobile driver, the switchboard and R&V operators, two observers, the motorcyclist and three linemen are T-6.

**Source:** War Department Table 27W "Headquarters and Headquarters Company, Infantry Battalion" June 27, 1927.

### Appendix 3.12

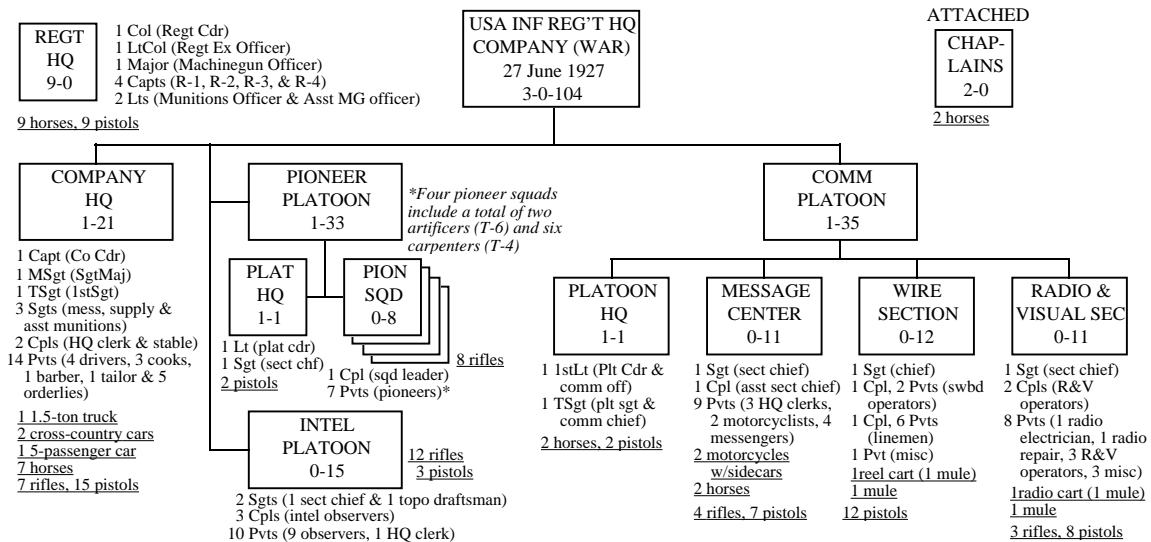

**Notes:**

**Small Arms:** Pioneer and Intelligence platoon personnel carry rifles except for the pioneer platoon commander, the sergeants and the HQ clerk in the intelligence platoon. In the rest of the company the messengers, the three miscellaneous privates in the radio and visual section, the barber, tailor and five messengers carry rifles.

**Transportation:** The officers, sergeant major, communication chief, orderlies and two messengers have riding horses.

**Enlisted Ranks:** Company includes 37 PFC. The carpenters, two cooks and the radio repairman are T-4. One cook and the intelligence platoon clerk are T-5. Artificers, truck, automobile, or motorcycle drivers, telephone linemen, switchboard and radio operators and three observers are T-6.

**Source:** War Department Table 24W "Headquarters and Headquarters Company, Infantry Regiment" June 27, 1927.

### Appendix 3.12

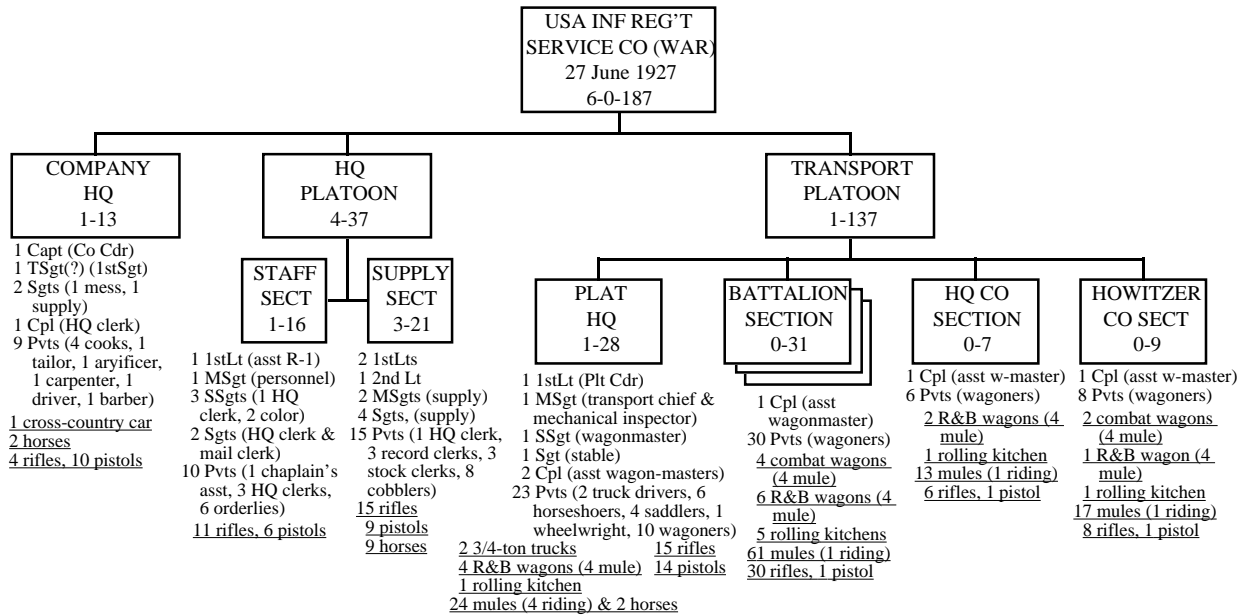

**Notes:**

Each rolling kitchen is to receive a two-mule water cart as soon as these vehicles are developed and procured. One of the two corporal assistant wagon-masters in the transport platoon headquarters commands the platoon headquarters' vehicles. The other supervises the regimental ammunition train.

**Small Arms:** Pistols issued to officers, master sergeants, the first sergeant, staff sergeants, the mess and supply sergeants, the stable sergeants, assistant wagon-masters, cooks, car and truck drivers, horse-shoers, and the chaplain's assistant.

**Transportation:** All officers, the first sergeant, the supply section master sergeants and the transportation chief have riding horses. The supply section sergeants, the stable sergeant, and the assistant wagon-masters have riding mules. Each four-mule rolling kitchen, rations and baggage (R&B or escort) wagon and each combat wagon has two drivers or wagoners.

**Enlisted Ranks:** Company can have up to 92 PFC. One carpenter, one HQ clerk and one record clerk are T-3. One HQ clerk, two record clerks, six horse-shoers, one wheelwright and two cooks are T-4. Two HQ clerks, two cooks, three cobblers and four saddlers are T-5. One artificer, three car and truck drivers, five cobblers and 57 wagoners are T-6.

**Source:** War Department Table 25W "Service Company, Infantry Regiment" June 27, 1927.

Appendix 3.13

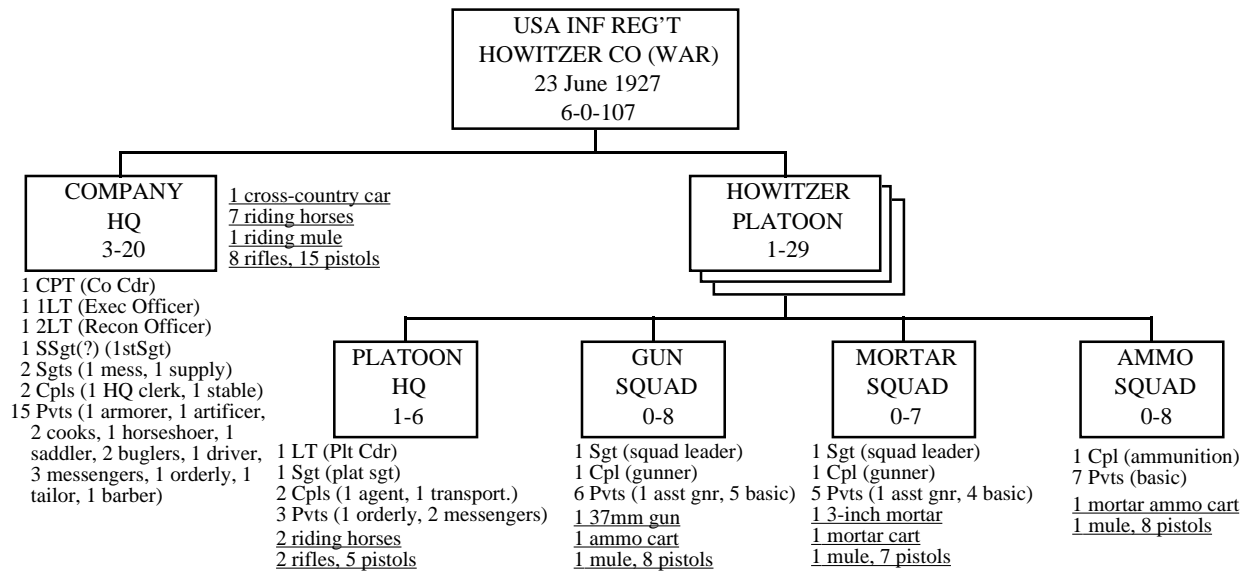

Notes:

Small Arms: Rifles carried by all messengers, the saddler, the armorer, the artificer, the tailor and the barber.

Transportation: Riding horses provided for all officers, the first sergeant, the platoon sergeants, the buglers and the orderly. The stable corporal rides a mule.

Enlisted Ranks: Company can have up to 23 PFC. The armorer, the horse-shoer and one cook are T-4. One cook and the saddler are T-5. The artificer, the automobile driver and the six assistant gunners are T-6.

Source: War Department Table 30W "Howitzer Company, Infantry Regiment" June 23, 1928.

Appendix 3.14

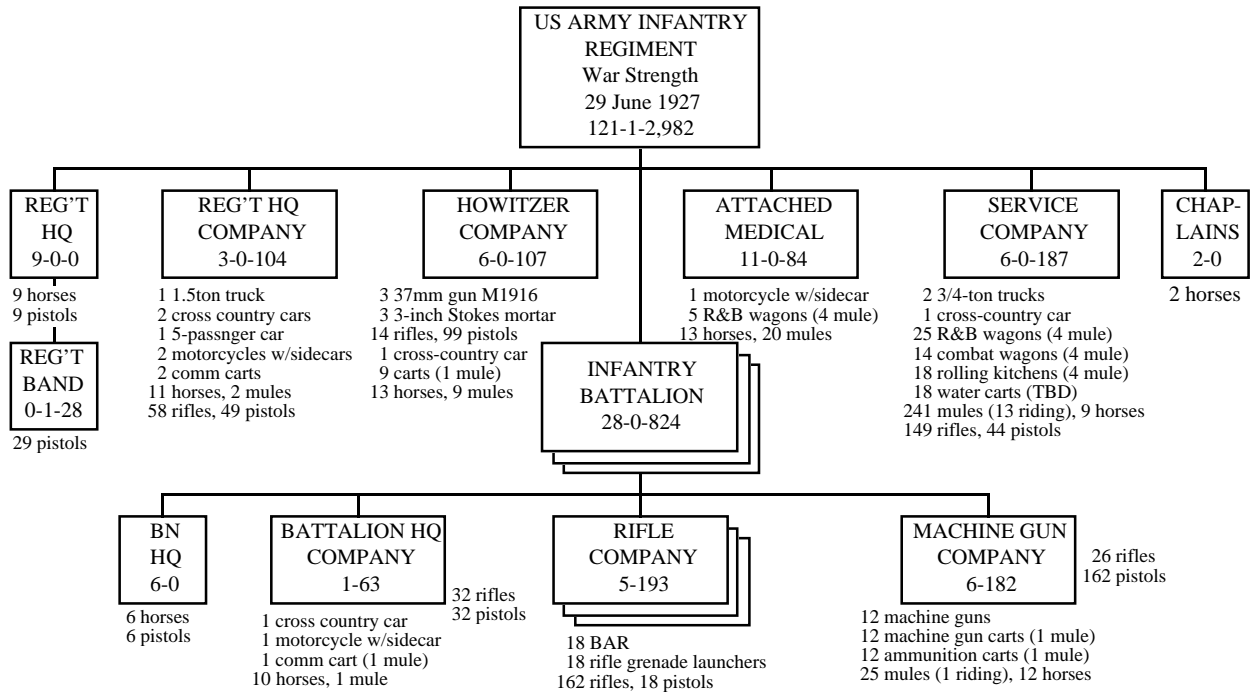

Notes:

Attached Medical: Authorized a major (with horse), five captains (one dental and four medical of whom four had horses), five first lieutenants (three medical, one dental and one veterinary, of whom one had a horse), one technical sergeant (horse), two staff sergeants (with horses), six sergeants (one veterinary with a horse), four corporals, 23 PFC and 47 privates of whom three are veterinary (two with horses). Of the privates and PFCs, 7 are T-4, two are T-5 and 15 are T-6.

Source: War Department Table 23W "Infantry Regiment" June 27, 1927.



Appendix 3.15

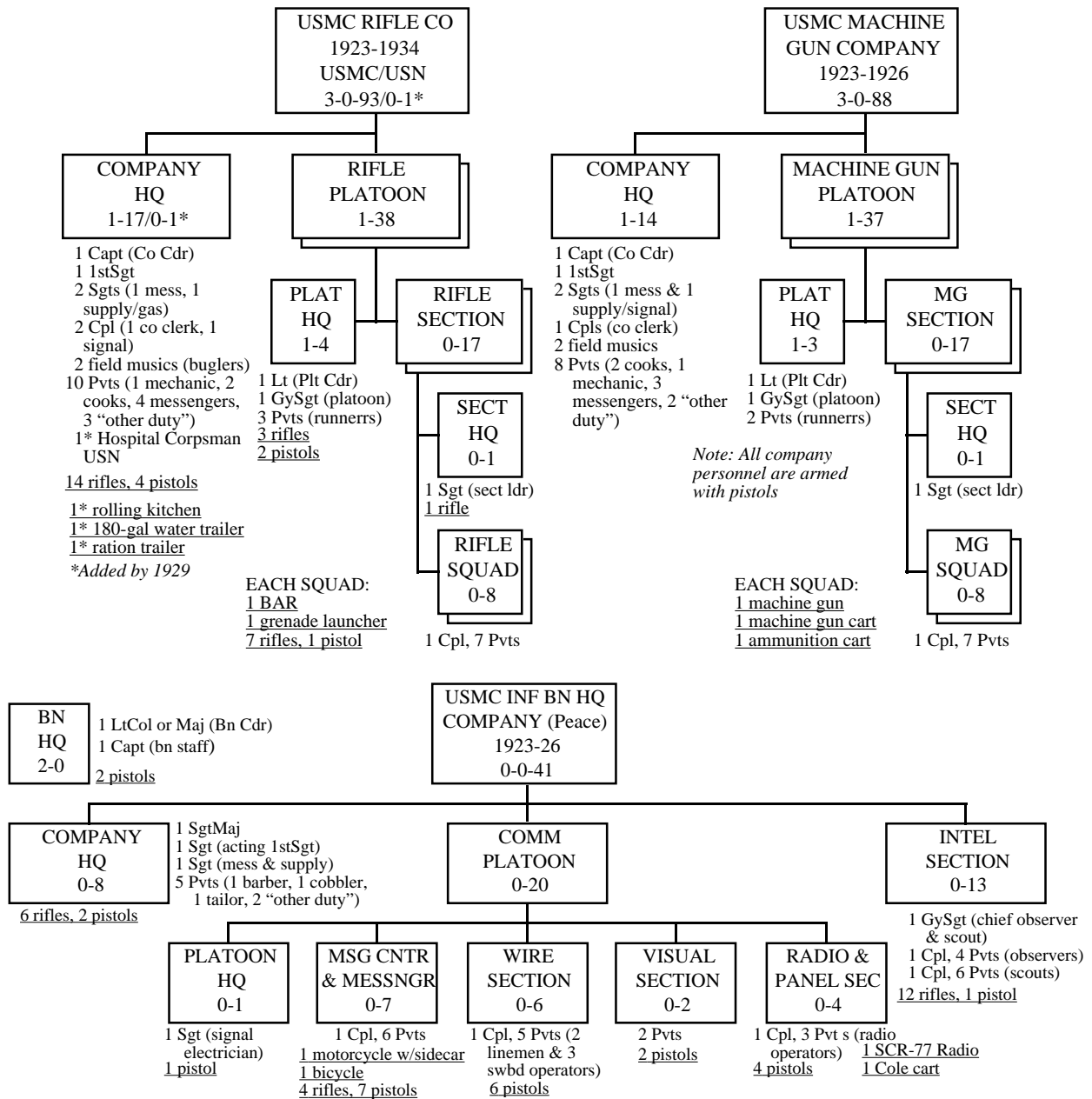

Notes:

**Small Arms:** Rifles only issued to messengers in the battalion communication platoon and not at all in the machinegun company but elsewhere they are issued to all Marines ranking as sergeants or below except field musics (actually buglers), automatic riflemen and the acting first sergeant in the headquarters company. It should also be noted that during the 1920's Lewis machineguns were frequently substituted for Browning Automatic Rifles (BAR) until the latter became sufficiently plentiful.

**Source:** "Table of Distribution for the Second Brigade to be effective 1 May 1923" Enclosed in a letter from the Commanding General Second Brigade to the Major General Commandant dated 1 April 1923, Record Group 127 Ellsdran File 2385-45 US National Archives Washington DC.

Appendix 3.16

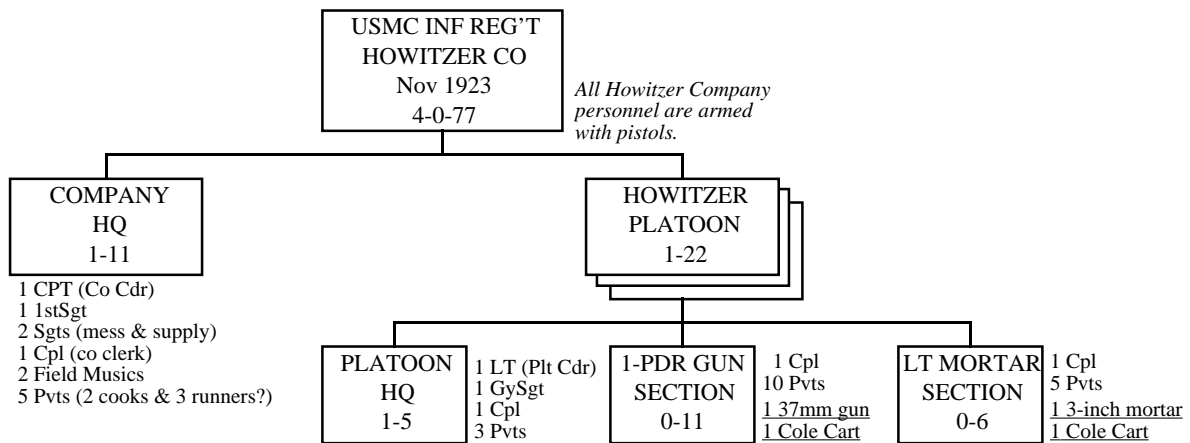
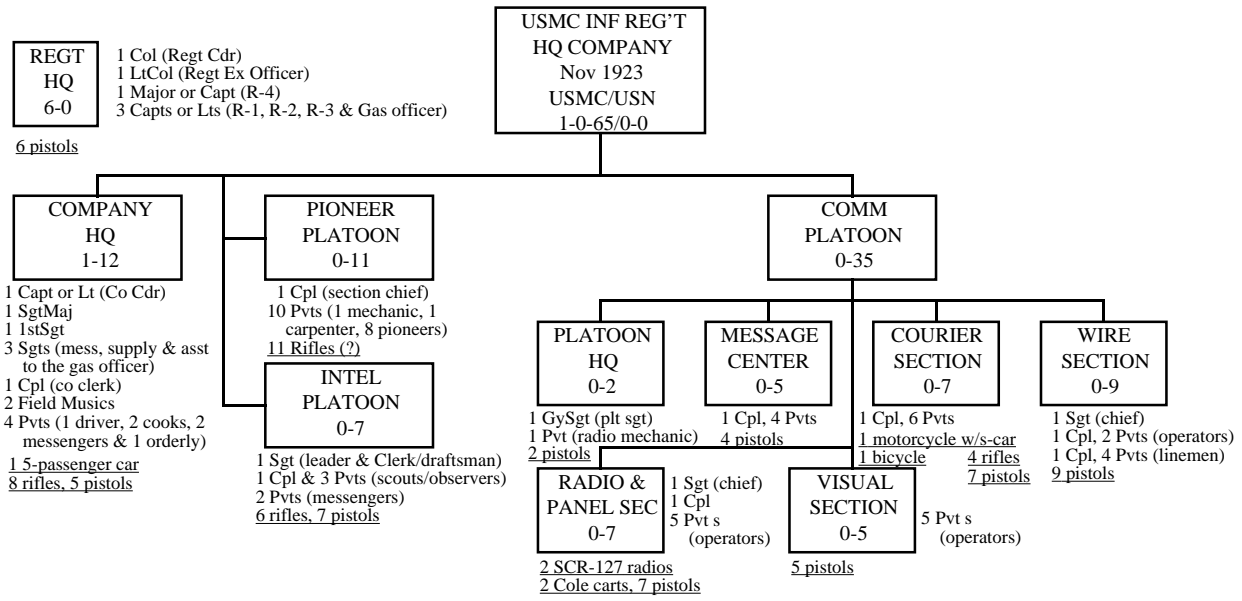

Notes:

**Headquarters Company:** The regimental adjutant (R-1) was also the headquarters company commander (just as the R-4 also commanded the service company). If an infantry regiment operated independently (not as part of a brigade, and this rarely occurred in practice) its headquarters company would be augmented. Company headquarters would lose its gas sergeant but receive eight additional privates. The intelligence platoon would get three more privates. The communication platoon would get a lieutenant, augment its message center to five corporals and five privates, add a private each to its courier and R&P sections, five privates to its wire section, and a corporal to its visual signal section. In addition the company would receive a military police platoon with a lieutenant, two sergeants, three corporals, and 24 privates.

**Howitzer Company:** A regiment that had a howitzer company would habitually attach a howitzer platoon to each of its infantry battalions.

**Source:** "Table of Distribution for the Second Brigade to be effective 1 May 1923" Enclosed in a letter from the Commanding General Second Brigade to the Major General Commandant dated 1 April 1923, Record Group 127 Ellsdran File 2385-45 US National Archives Washington DC. This source merely listed the number and ranks of Marines authorized for these organizations. It did not list their duties or (except for the rifle, machinegun and howitzer companies) their personal weapons but these are relatively easy to infer from the context. Vehicles are also not listed though Cole carts would have to have been supplied for crew-served weapons and radios. Animals were not listed because these might or might not be available, depending on the circumstances. A unit at sea or recently landed would have no animals. A unit that was operating ashore for an extended time would have mules for its Cole carts and probably pack mules as well. Outside of the rifle companies field musics most other personnel ranking above sergeant would be likely to have riding horses or mules.

**Appendix 3.17**

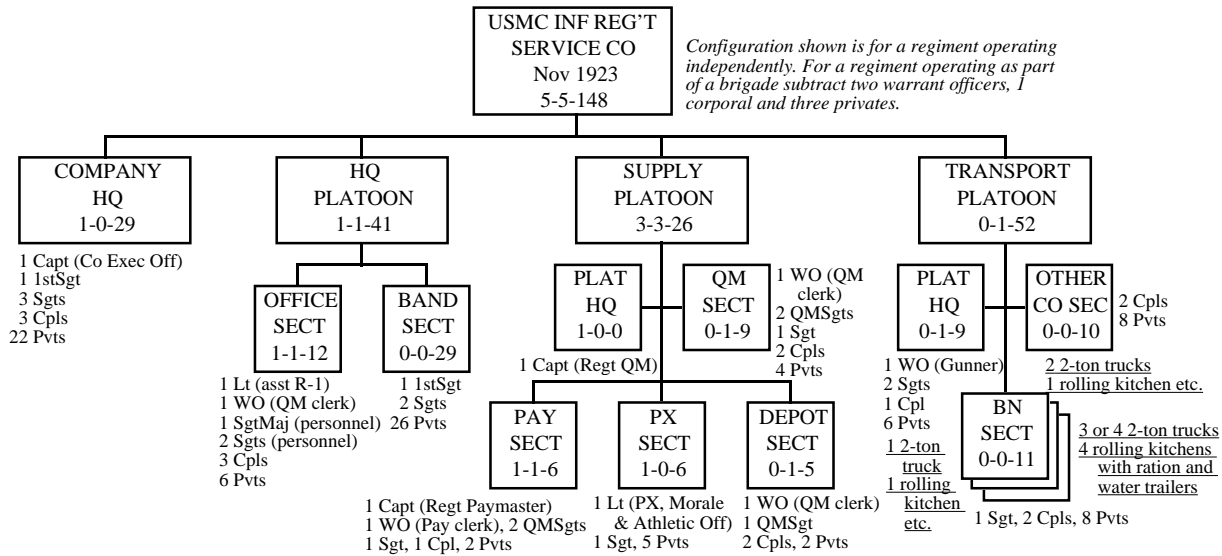

**Notes:**

The regimental supply officer (R-4), though a member of the regimental staff, was also the service company commander. The service company diagram shown above is configured for a regiment operating independently (not as part of a brigade). This writer was unable to find a detailed breakdown of a service for a regiment operating as part of a brigade. However the difference between the two is small. The company in a regiment operating under a brigade headquarters would have three warrant officers rather than five, only 19 corporals rather than 20 and only 102 privates rather than 105. It is likely that the missing corporal and privates would come from the "other companies" section of the transportation platoon. The missing warrant officers would most likely be subtracted from either the quartermaster or depot sections and from the office (personnel) section.

Small Arms: These were not shown in the original papers but it is likely that the basic rule of rifles for sergeants and below (except field musics) and pistols for everyone else would have been followed. All band members would have carried pistols.

Transportation Platoon: The vehicles shown in the transportation platoon would vary considerable in type and quantity, depending on what was required and what was available. The numbers shown should be regarded as a very general estimate only.

Source: "Table of Distribution for the Second Brigade to be effective 1 May 1923" Enclosed in a letter from the Commanding General Second Brigade to the Major General Commandant dated 1 April 1923, Record Group 127 Ellsdran File 2385-45 US National Archives Washington DC.

**Appendix 3.18**

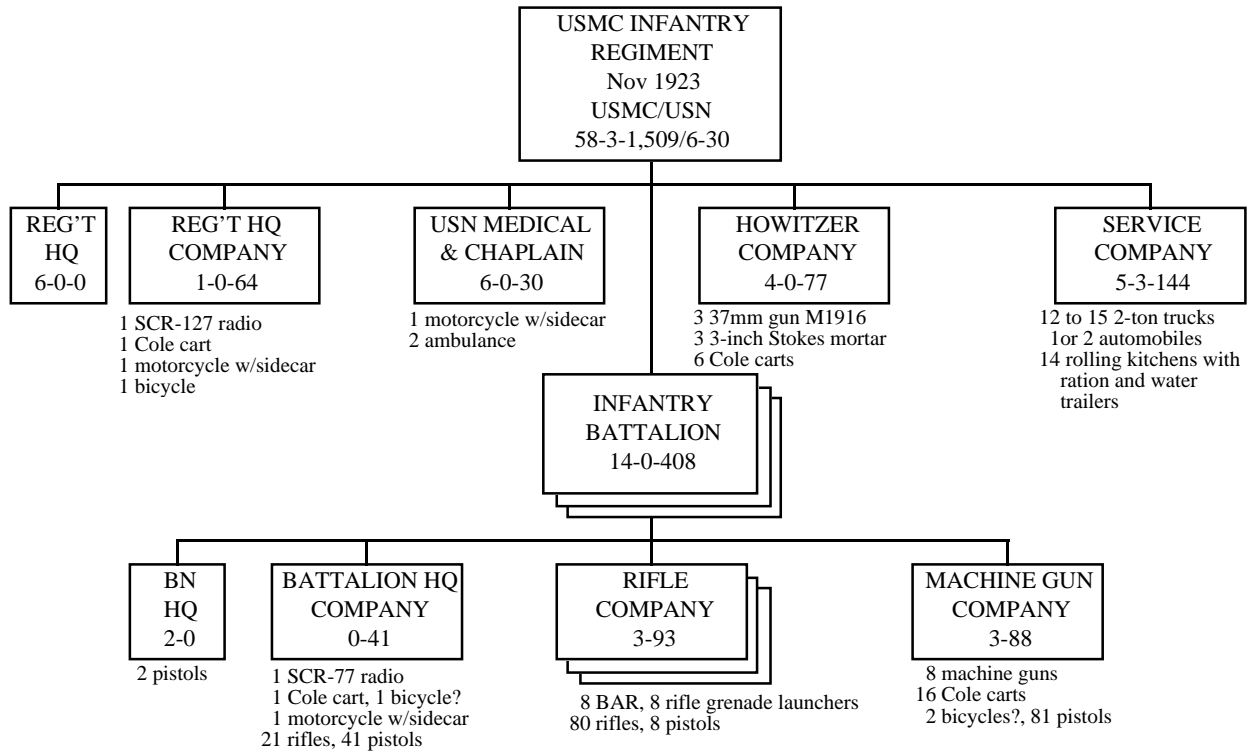

**Notes:**

**Medical and Chaplain:** This section included four medical officers, a dental officer, a chaplain, one hospital corpsman for each rifle or machinegun with the rest assigned to the battalion and regimental aid stations.

**Headquarters and Services:** Strengths shown are for those for a regiment operating as part of a brigade.

**Source:** "Table of Distribution for the Second Brigade to be effective 1 May 1923" Enclosed in a letter from the Commanding General Second Brigade to the Major General Commandant dated 1 April 1923, Record Group 127 Ellsdran File 2385-45 US National Archives Washington DC.

Appendix 3.19

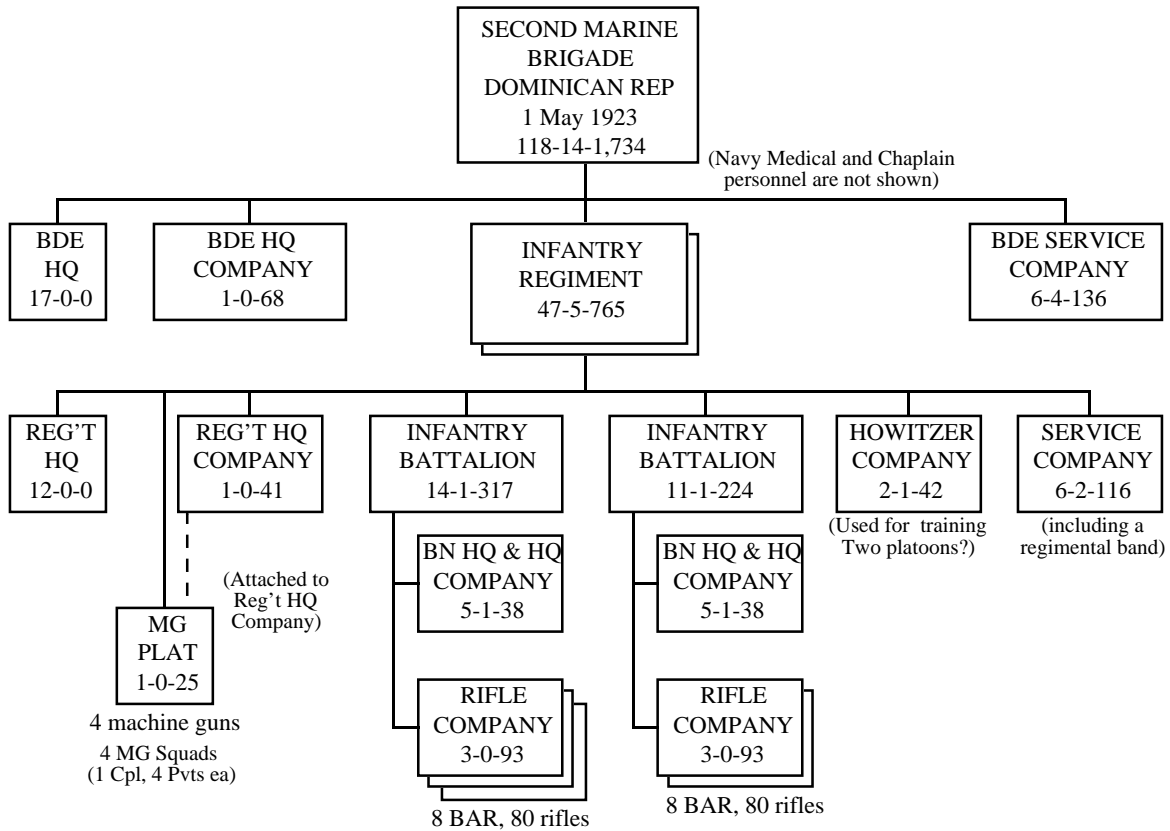

Source: Letter from the Major General Commandant to the Commanding General of the Second Brigade, 2 August 1922 and a table showing the distribution of the Second Brigade, dated at the Brigade Headquarters, Santo Domingo City on 7 April and to become effective 1 May 1923; both items in Record Group 127 Ellsdran folder 2385-45, US National Archives Washington DC.

Appendix 3.20

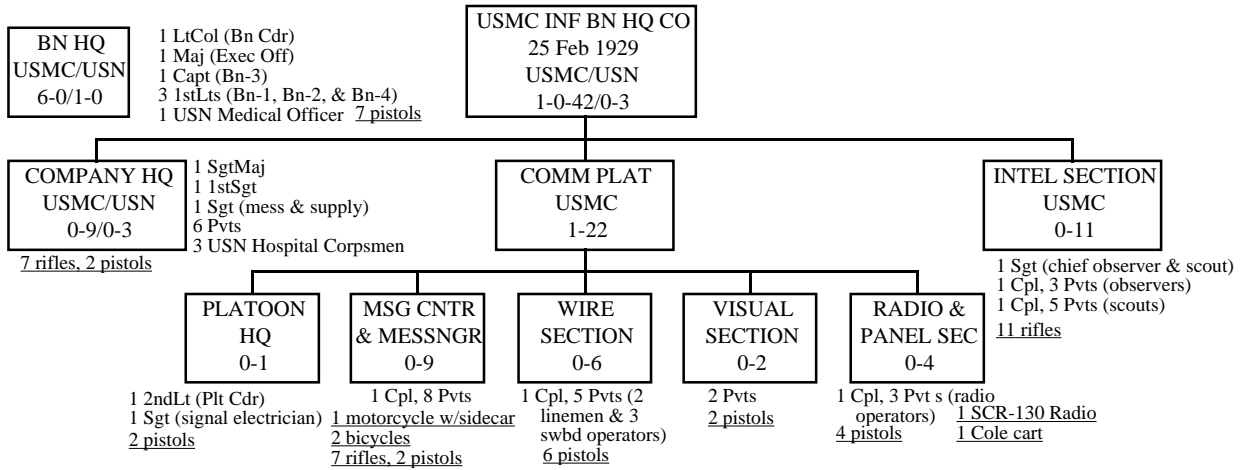
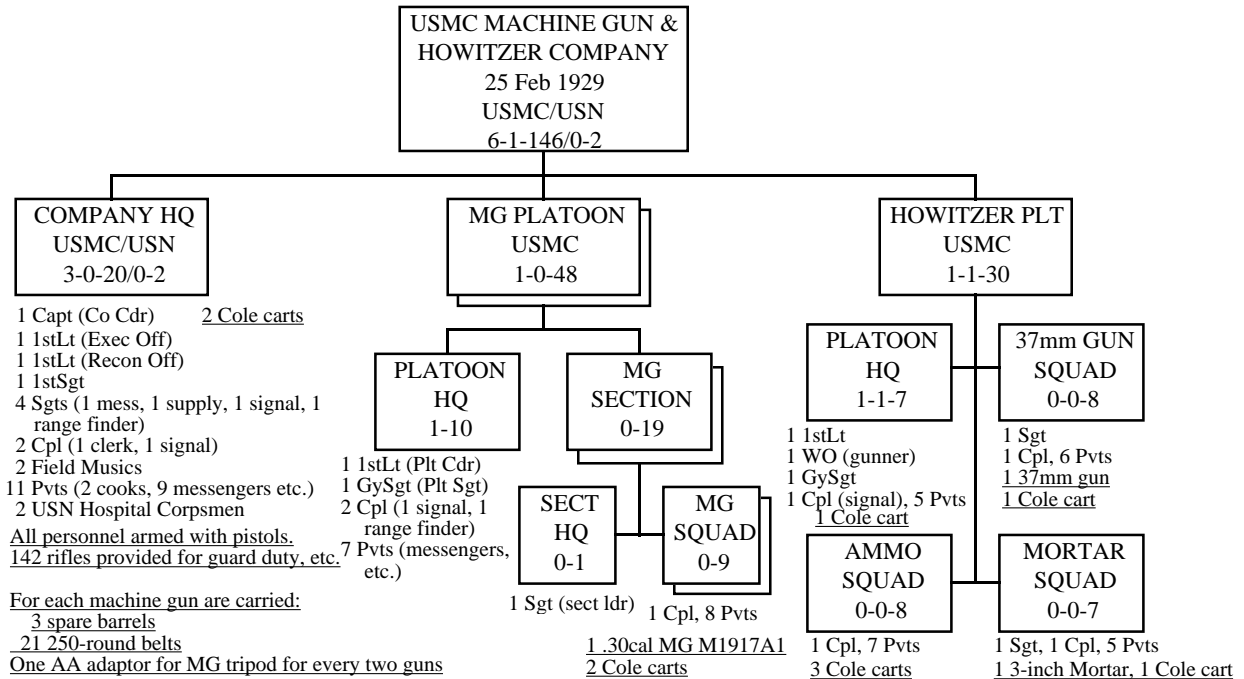

Notes:

**Communication Platoon:** The wire section included two BD-9 switchboards (plus spares) and seven EE-5 telephones. The visual section had an EE-6 signal lamp.

**Source:** "Equipment and Tonnage Tables for Expeditionary Organization, United States Marine Corps, Peace and War Strength" approved 9 September 1929 Record Group 127 Entry No. 27 US National Archives Washington DC.

### Appendix 3.21

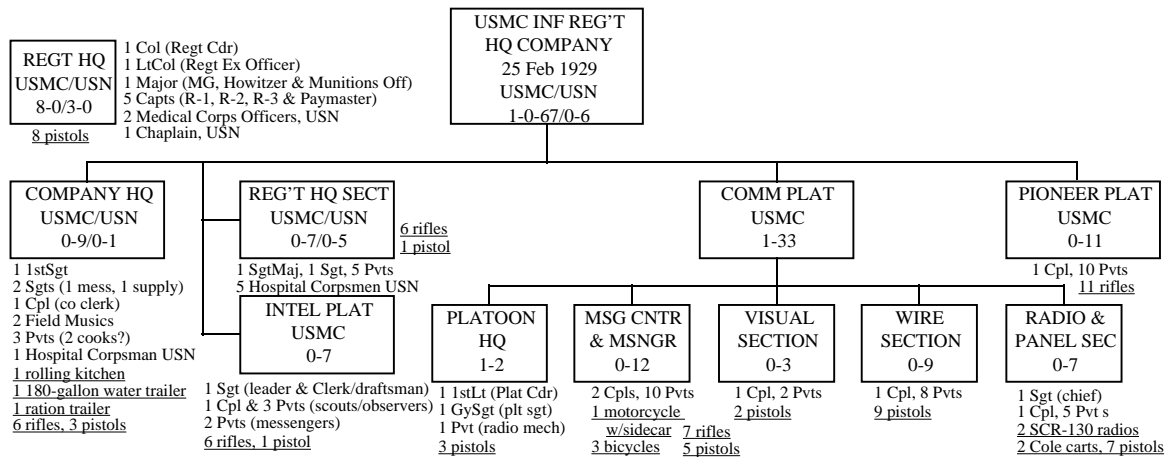

**Notes:**

The commander of the former regimental howitzer company is now the regimental machinegun, howitzer and munitions officer and, together with the regimental pay officer, has been made a member of the regimental staff. The regimental adjutant (R-1) also commands the regimental headquarters company.

**Communication Platoon:** In addition to two SCR-130 radios in the radio and panel section, the wire section included two BD-11 switchboards (plus spares) and 10 EE-5 field telephones. The visual section had an EE-7 signal lamp.

**Source:** "Equipment and Tonnage Tables for Expeditionary Organization, United States Marine Corps, Peace and War Strength" approved 9 September 1929 Record Group 127 Entry No. 27 US National Archives Washington DC.

### Appendix 3.22

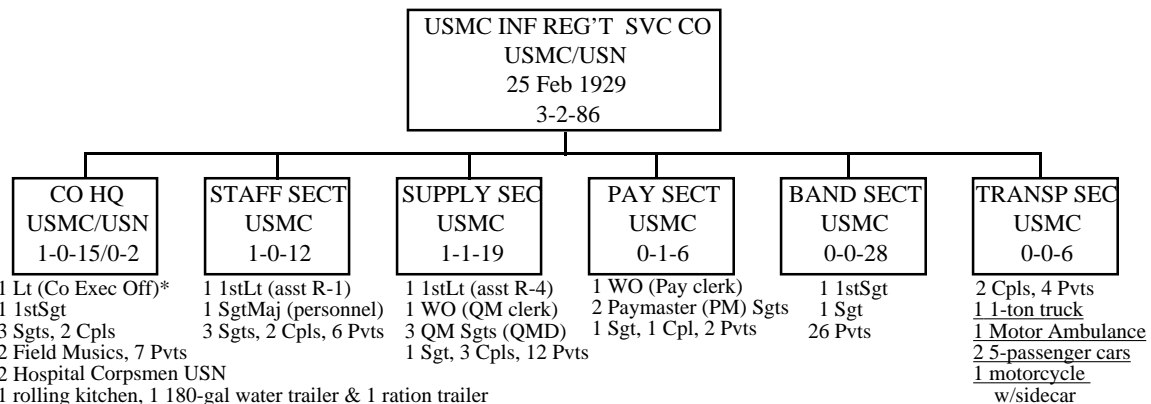

**Notes:**

The regimental supply officer (R-4) commands the service company, though he in the diagrams as a member of the regimental staff. The paymaster is also depicted with the staff although he also commands the pay section. A truck or tractor company from the trains of the regiment's parent brigade (with two officers, 62 men 12 2-ton trucks or tractors with 3-ton trailers will provide most of the regiment's motor transport requirements.

**Source:** "Equipment and Tonnage Tables for Expeditionary Organization, United States Marine Corps, Peace and War Strength" approved 9 September 1929 Record Group 127 Entry No. 27 US National Archives Washington DC.

**Appendix 3.23**

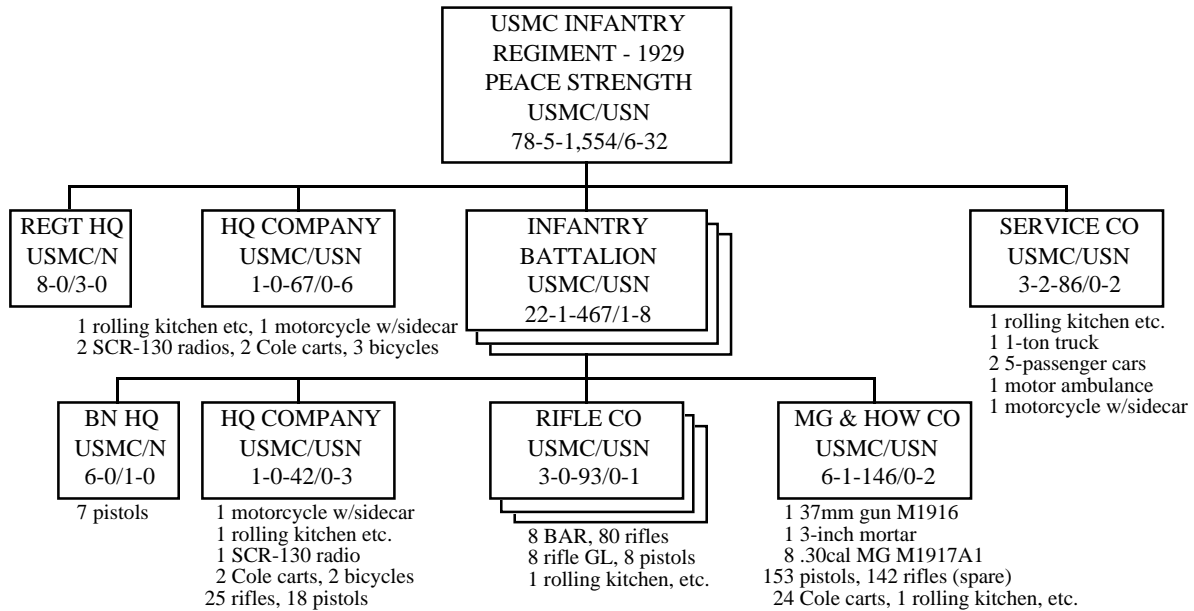

Notes:

Source: "Equipment and Tonnage Tables for Expeditionary Organization, United States Marine Corps, Peace and War Strength" approved 9 September 1929 Record Group 127 Entry No. 27 US National Archives Washington DC.

**Appendix 3.24**

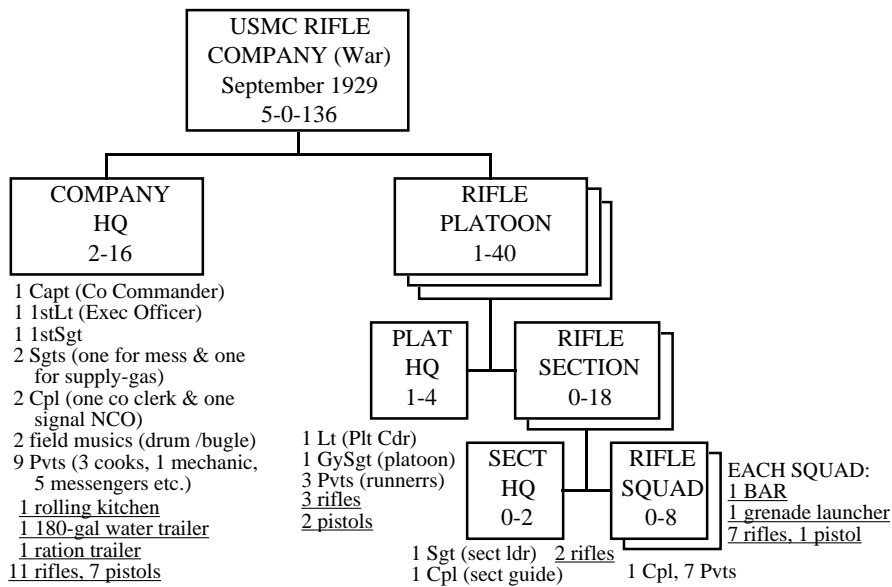

Notes:

Source: "Equipment and Tonnage Tables for Expeditionary Organization, United States Marine Corps, Peace and War Strength" approved 9 September 1929 Record Group 127 Entry No. 27 US National Archives Washington DC.



**Appendix 3.25**

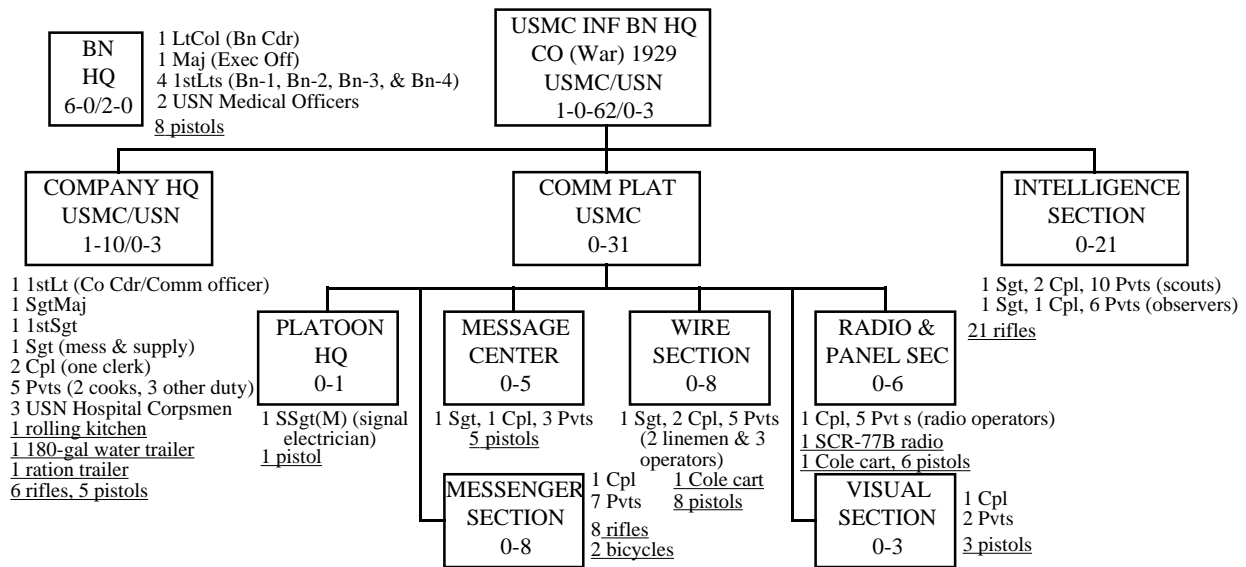

Notes:

Source: "Equipment and Tonnage Tables for Expeditionary Organization, United States Marine Corps, Peace and War Strength" approved 9 September 1929 Record Group 127 Entry No. 27 US National Archives Washington DC.

**Appendix 3.26**

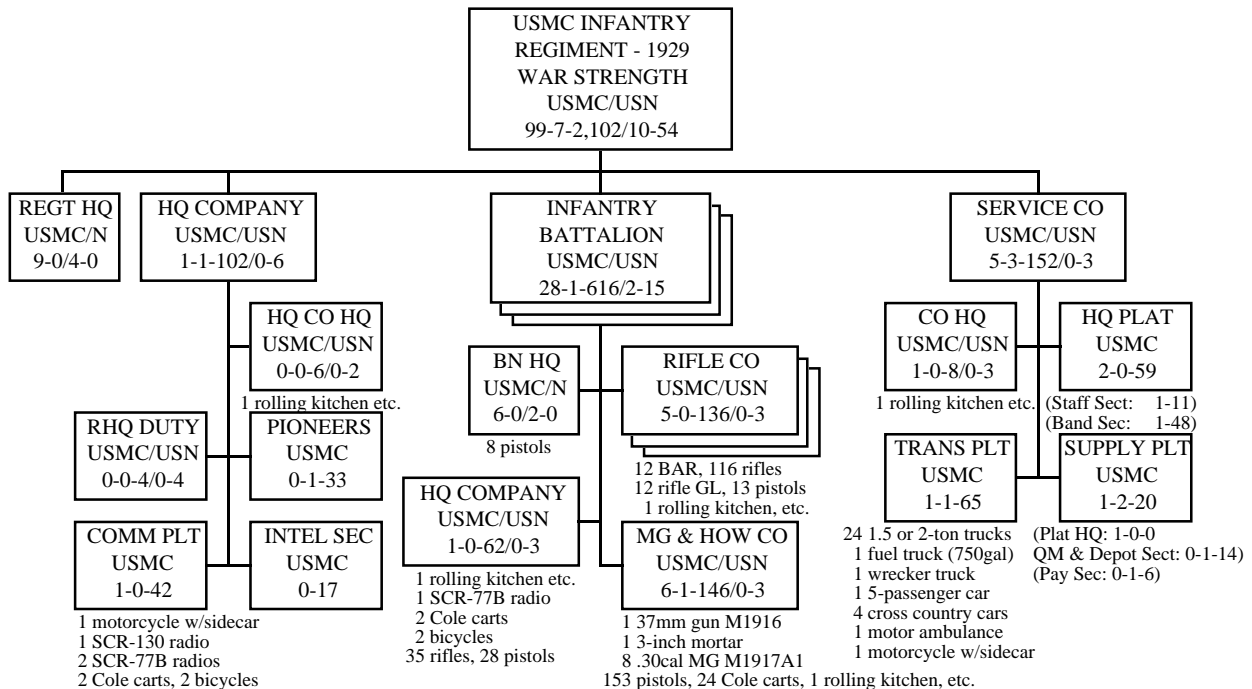

Notes:

Small Arms: Only 14 service company personnel (mostly in the transportation platoon) carried rifles. In the headquarters company 67 men carried rifles. The transportation platoon operated in five sections: the platoon headquarters (a lieutenant, a warrant officer, a staff sergeant (mechanical), two sergeants, a corporal, and 10 privates), three battalion sections (a corporal and 12 privates each) and a headquarters company section (two corporals and 10 privates).

Source: "Equipment and Tonnage Tables for Expeditionary Organization, United States Marine Corps, Peace and War Strength" approved 9 September 1929 Record Group 127 Entry No. 27 US National Archives Washington DC.

## APPENDIX 4

### Appendix 4.1

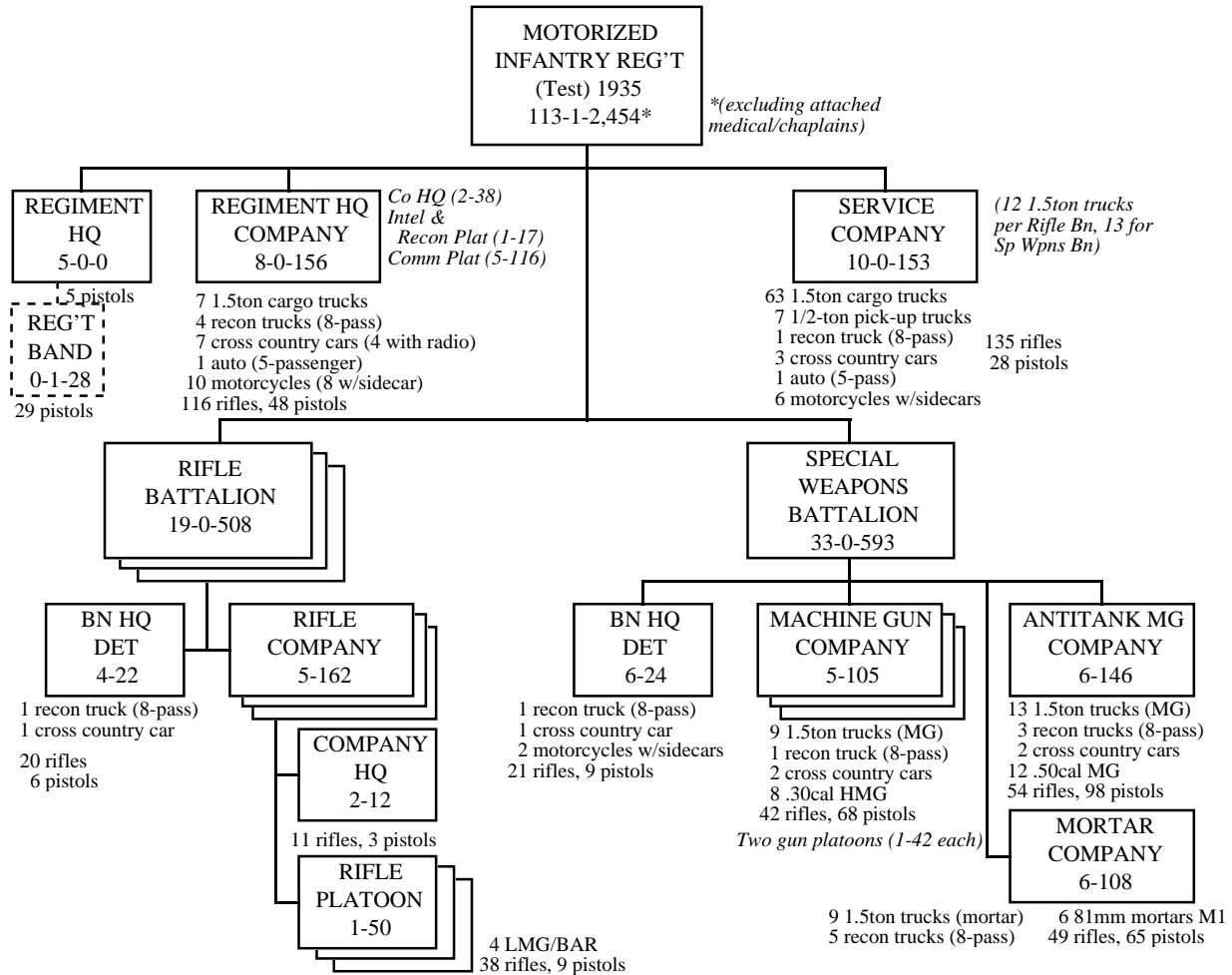

**Notes:**

Source: The Infantry School "The New Infantry Regiment" and "Tactical Aspects of the Proposed New Regiment" The Infantry School *Mailing List* Volume XI January 1936 (The US Army Infantry School, Fort Benning Georgia) pp. 1-52.

## Appendix 4.2

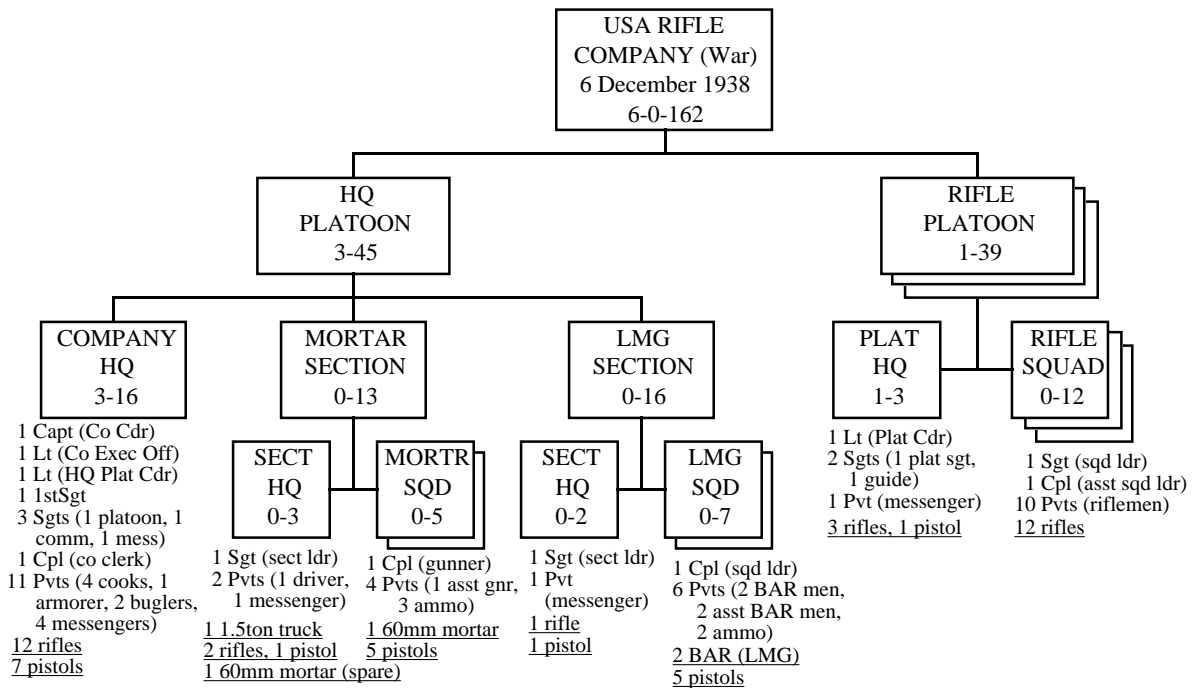

### Notes:

**Company Headquarters:** This was tactically organized in three elements. The captain's group with the company commander, first sergeant, communication sergeant, the buglers and a couple of messengers commanded the company as a whole. A smaller group under the headquarters platoon commander (including the platoon sergeant and one or two messengers) would command the two weapon sections. The administrative group (under the executive officer), with the mess sergeant, cooks, armorer, and clerk, handled company logistics as in previous organizations.

**The First Sergeant:** In this table of organization (like many others) the First Sergeant's actual rank was not specified. Readers should remember that an actual rank of First Sergeant has only existed in the US Army since about 1956. Prior to that time the first sergeant was merely the senior enlisted man in his respective company. In this company the first sergeant was likely to be a staff sergeant or possibly a technical sergeant, depending on who was available.

**Small Arms Distribution:** Pistols are issued to officers, the first sergeant, the communication sergeant, buglers and all members of the mortar and LMG sections (except their messengers). All other personnel (except automatic riflemen) carry rifles.

**Source:** US Army Adjutant General Table of Organization T/O 7-17 "Infantry Company, Rifle" (Washington DC 6 December 1938).

### Appendix 4.3

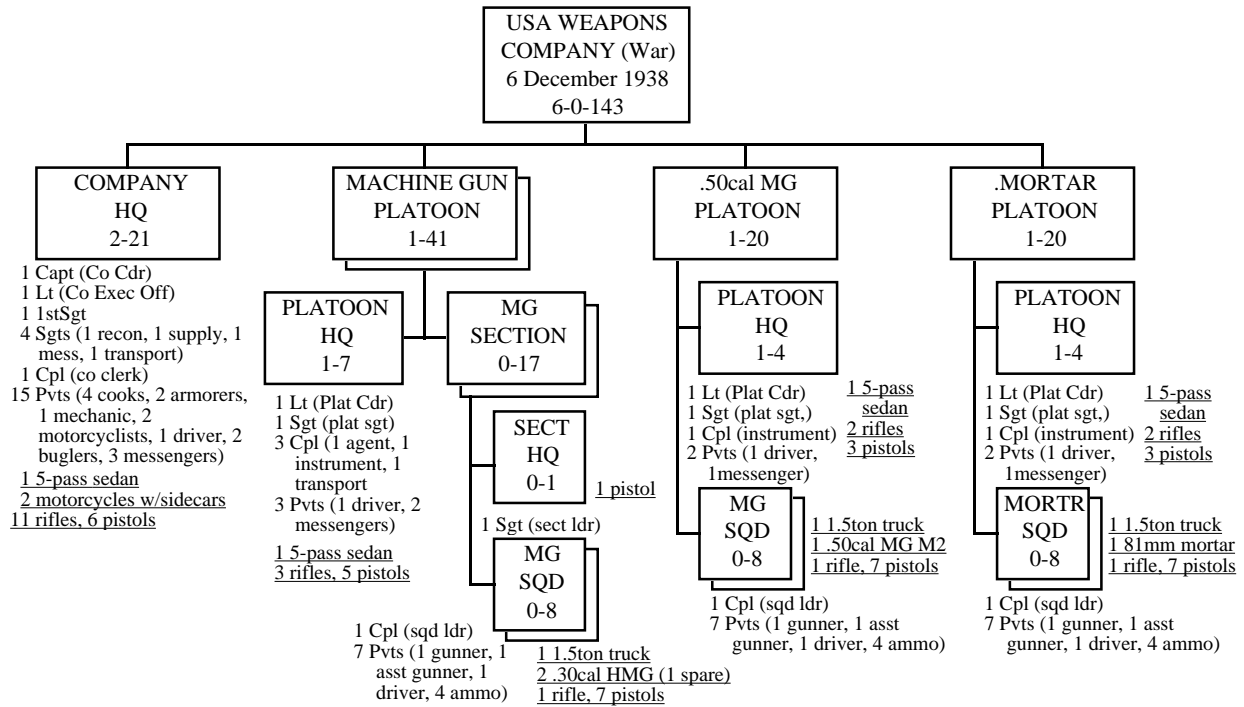

**Notes:**

**Small Arms Distribution:** All personnel in the machinegun, .50-caliber, and mortar platoons carry pistols except the drivers and messengers. In the company headquarters only the officers, first sergeant, recon and signal sergeant and the buglers carry pistols.  
**Source:** US Army Adjutant General Table of Organization T/O 7-18 "Infantry Company, Heavy Weapons (Motorized)" (Washington DC 6 December 1938).

### Appendix 4.4

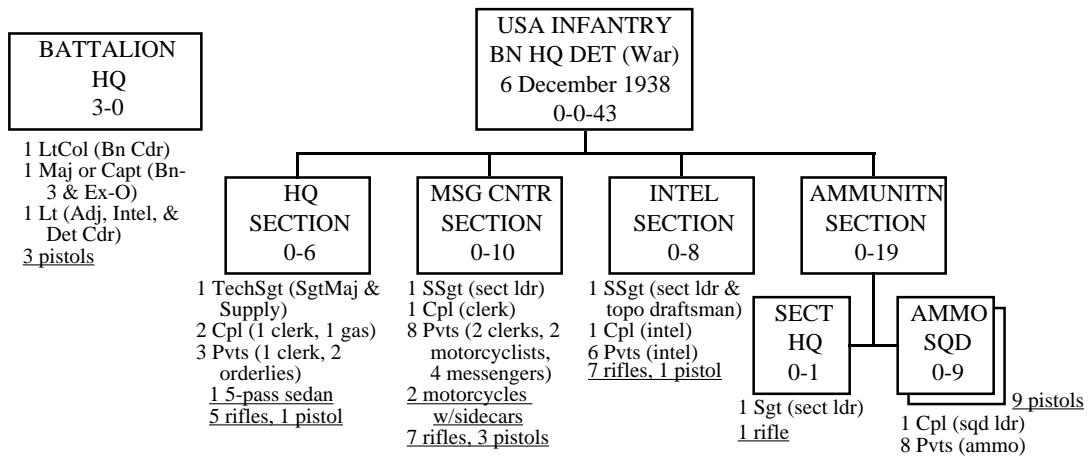

**Notes:**

**Small Arms Distribution:** Pistols are issued to all officers, the headquarters section technical sergeant, the message and intelligence section leaders, the two motorcyclists and all ammunition section members (except the leader).  
**Source:** US Army Adjutant General Table of Organization T/O 7-16 "Infantry Headquarters and Headquarters Detachment, Battalion Rifle" (Washington DC 6 December 1938).

## Appendix 4.5

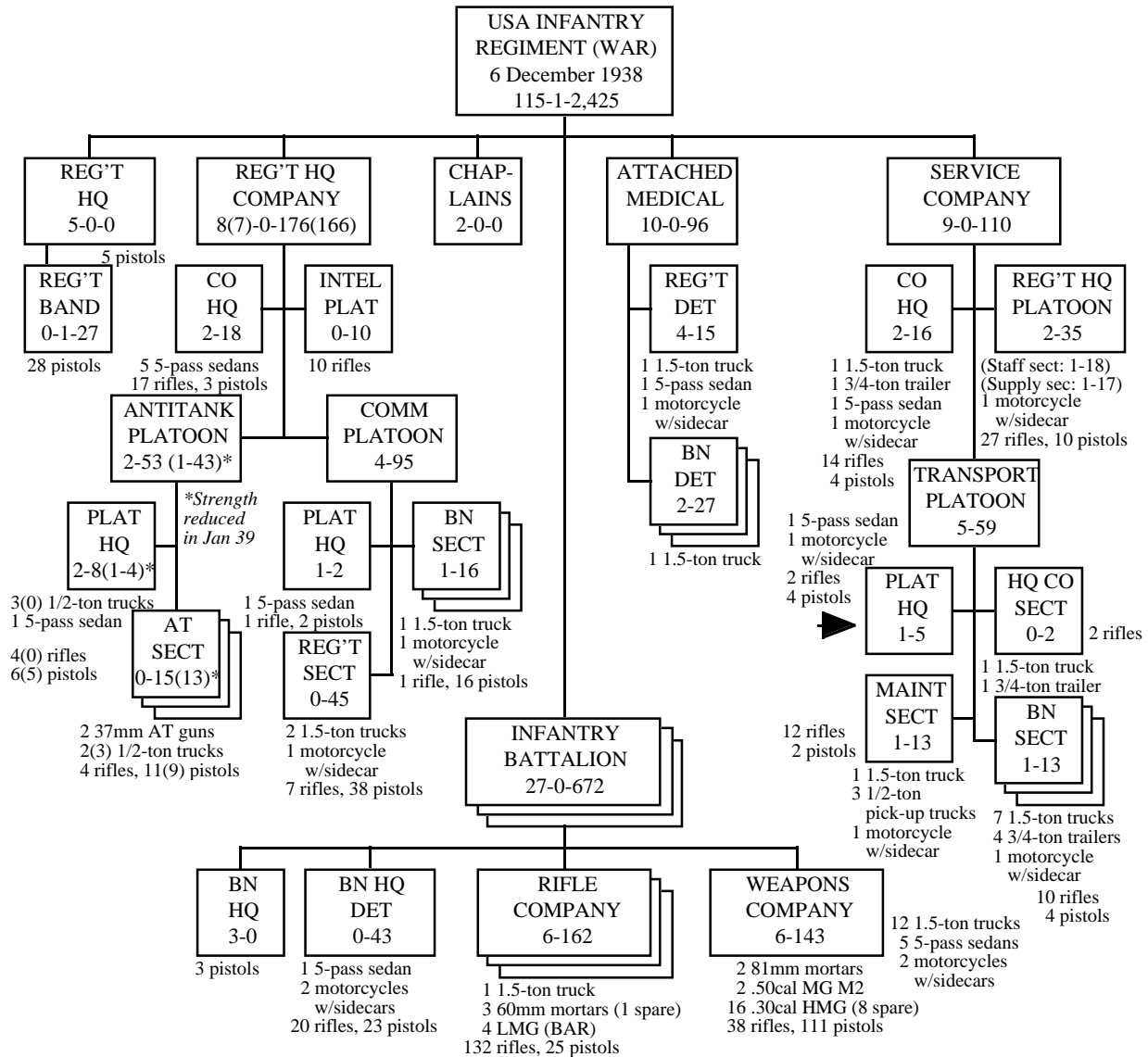

**Notes:**

**Regimental Headquarters:** Included a colonel, lieutenant colonel (executive officer), a captain or major serving as plans and training officer (S-3), and a captain serving as adjutant (S-1). The S-2 officer was for wartime only. In peacetime, the S-3 also performed S-2 duties. The supply officer (S-4) was not included on the regimental staff since he was already a member of the service company, though he did not command it. Regimental headquarters would also have two attached chaplains.

**Intelligence Platoon (Regimental Headquarters Company):** In peacetime it just had an intelligence sergeant and a draftsman. In war it would also receive two corporals and six privates to act as scouts and observers.

**Antitank Platoon (Regimental Headquarters Company):** Its three gun sections, each had a sergeant, two messengers and two gun squads. A gun squad had a corporal (leader), gunner, assistant gunner, driver, and two ammunition bearers (reduced to one in January 1939). Platoon headquarters had a platoon leader and an assistant platoon leader (both lieutenants), a platoon sergeant, an instrument (range finding) corporal, a corporal liaison "agent," and four drivers to operate the platoon commander's vehicle and three ammunition trucks carrying 160 rounds of 37 mm each. Gun towing trucks carried 70 rounds each. In March 1940 the assistant platoon leader, the liaison agent, and the three ammunition truck drivers were all dropped from the platoon headquarters. Their trucks went to the three section headquarters where the section messengers would operate them. A new 1/2-ton command truck replaced the platoon commander's original *Phaeton*.

**Communication Platoon (Regimental Headquarters Company):** The regimental section had 20 men in its wire and 13 in its radio/visual subsections while each battalion had 13 and five men, respectively.

A detailed discussion of the Regimental Service Company and the Medical Detachment is included in the text.

**Source:** US Army Adjutant General T/O 7-11 "Infantry Regiment, Rifle" (Washington DC 6 December 1938).

Appendix 4.6

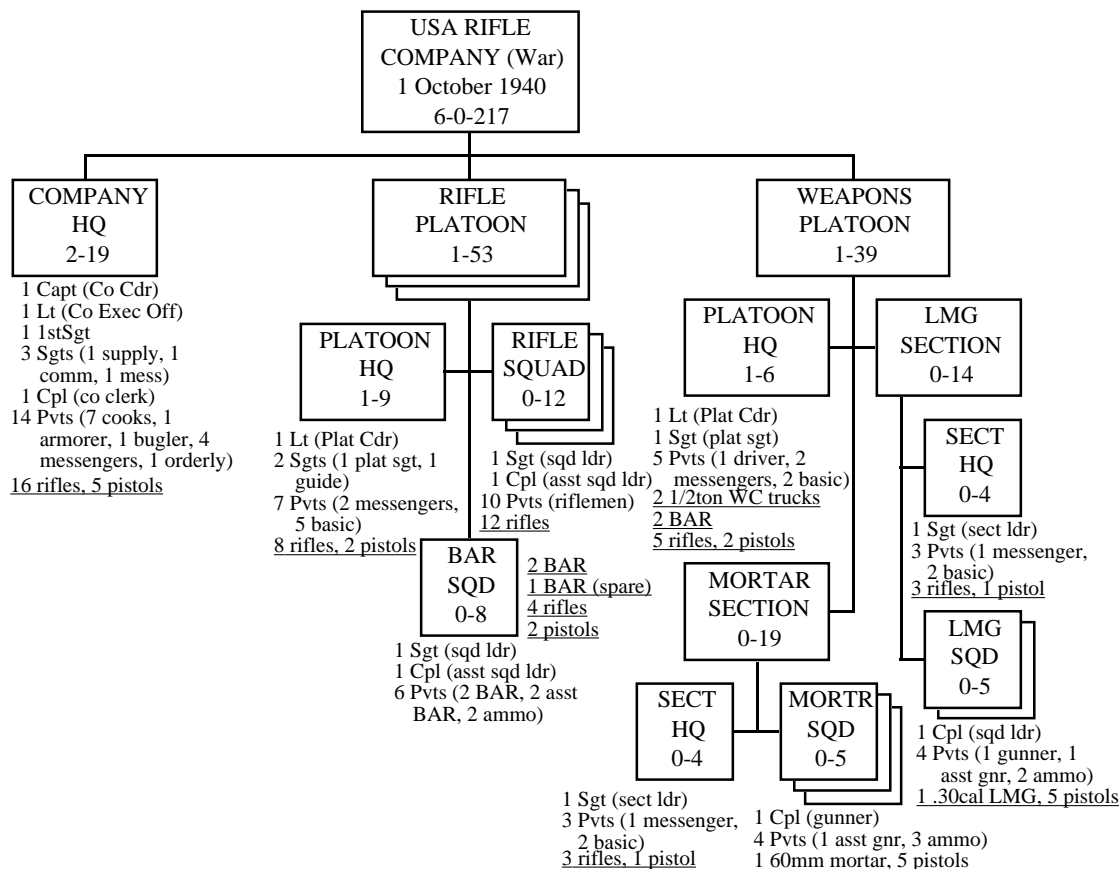

Notes:

**Small Arms Distribution:** Pistols issued to all weapons platoon personnel except messengers, drivers, and basic privates. Rifles issued to all rifle platoon and company headquarters personnel except the officers, first sergeant, communication sergeant, the platoon guides, the bugler, the automatic riflemen and the assistant automatic riflemen. Two BAR provided as additional weapons to protect the two trucks in the weapons platoon headquarters platoon from air attack. The spare BAR indicated in the diagram for each BAR squad was intended for use by the BAR squad in “defensive” combat situations.

**Enlisted Ranks:** Up to 70 (later reduced to 58) privates in the company could rank as PFC. Two cooks were rated as T-3 technicians. Two more cooks and the armorer (actually the armorer-artificer) were T-4 (the other three cooks were actually cook’s helpers). One driver was a T-5. The other driver, the two LMG gunners, and the automatic riflemen in the BAR squads rated as T-6.

**Source:** US Army Adjutant General Table of Organization T/O 7-17 “Infantry Company, Rifle” (Washington DC 1 October 1940).

Appendix 4.7

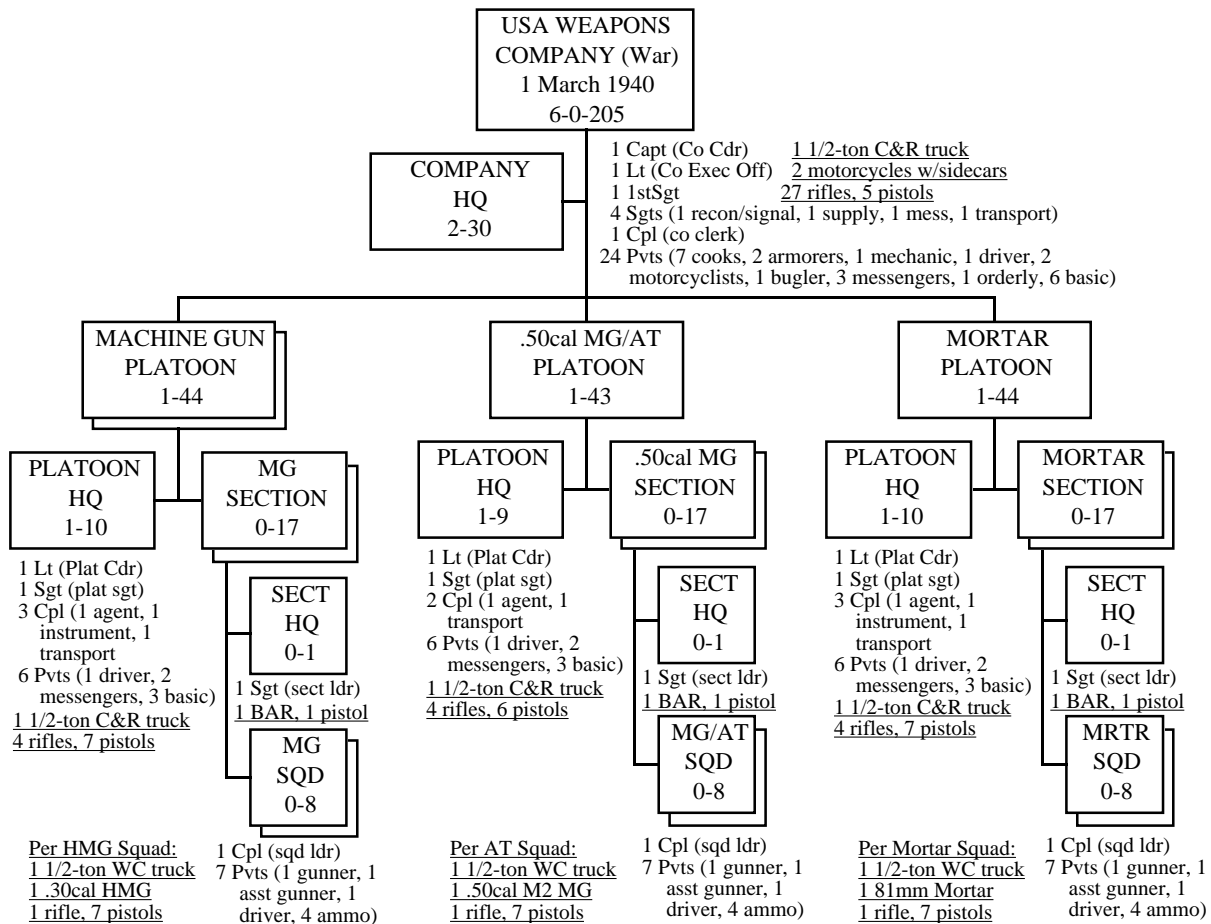

Notes:

In the weapons company the company executive officer was also the reconnaissance officer. The first sergeant would command the rear echelon (or administrative group).

**Small Arms Distribution:** Rifles were issued to all drivers, messengers, transport corporals and to all company headquarters personnel except officers, the first sergeant, the reconnaissance and signal sergeant and the bugler. One BAR per weapon section provided as additional weapons to protect the section's trucks from air attack.

**Enlisted Ranks:** The table of organization does not indicate what rank the first sergeant held. Up to 64 (later reduced to 54) privates in the company could rank as PFC. Two cooks and one motor mechanic were rated as T-3 technicians. Two more cooks and the two armorers (actually the armorer-artificers) rated as T-4 (the other three cooks were actually cook's helpers). One motorcyclist and 11 drivers were T-5. The other motorcyclist, 10 drivers and 16 machinegun and mortar gunners rated as T-6.

**Source:** US Army Adjutant General Table of Organization T/O 7-18 "Infantry Company, Heavy Weapons" (Washington DC 1 October 1940).

### Appendix 4.8

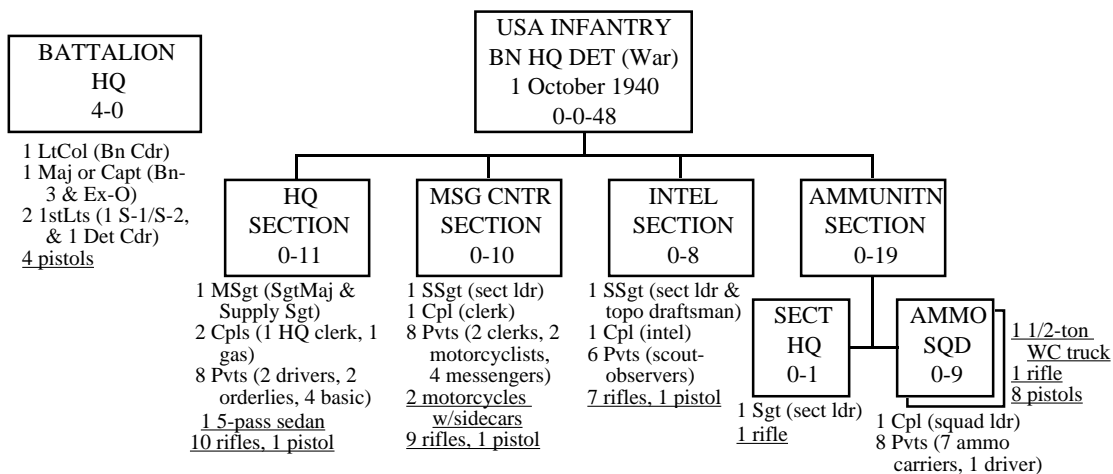

**Notes:**

The first lieutenant detachment commander is also the battalion transport officer.

**Small Arms Distribution:** Pistols are issued to all officers, the headquarters section technical sergeant, the message and intelligence section leaders and all ammunition section members (except the leader and the drivers in the ammunition squads). The motorcyclists now carried rifles rather than the pistols they had carried in 1938-39.

**Enlisted Ranks:** Up to 16 (later reduced to 13) privates in the company could rank as PFC. Two driver, one motorcyclist and three scout observers were T-5. The remaining two drivers, the other motorcyclist and three scout-observers rated as T-6.

**Source:** US Army Adjutant General Table of Organization T/O 7-16 "Infantry Headquarters and Headquarters Detachment, Battalion Rifle" (Washington DC 1 October 1940).



## Appendix 4.9

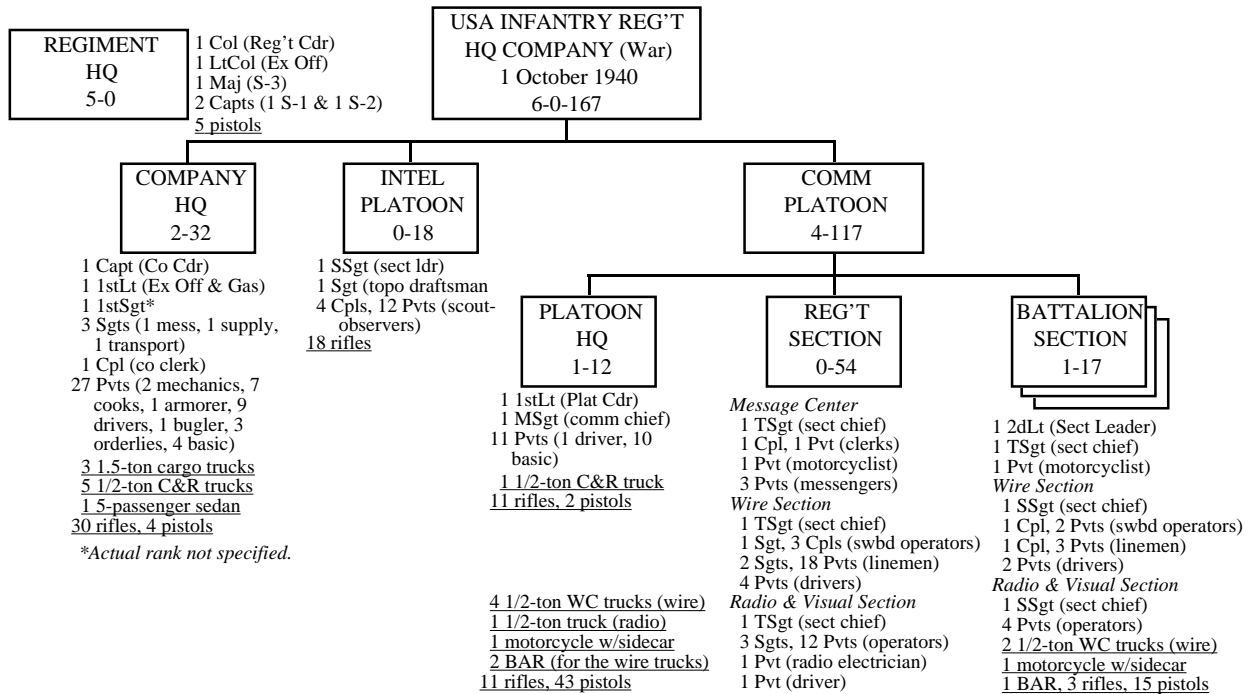

**Notes:**

Changes to the Communication Platoon since December 1938: Platoon headquarters augmented by 10 basic privates. Each battalion section receives one more driver. The regimental section receives six more telephone linemen to support the new antitank company and three additional drivers.

Radio Equipment: The regimental section has one truck-mounted long-range SCR-245 (added since 1938), two SCR-171, two SCR-131 and two (man-pack) SCR-195. Each battalion section has one SCR-131 and two SCR-195.

Small Arms Distribution: In the headquarters company headquarters and the communication platoon headquarters the officers, the first sergeant, the communication chief and the bugler carried pistols. All personnel in the regimental and three battalion sections of the communication platoon carried pistols except drivers, motorcyclists, messengers, and clerks. Company elements include a total of five BAR for use as additional weapons to protect the company's motor vehicles from air attack.

Enlisted Ranks: Up to 51 (later reduced to 42) privates in the company could rank as PFC. Two cooks, one motor mechanic, eight radio operators and one radio electrician were rated T-3. Two more cooks, the armorer (actually the armorer-artificer), one motor mechanic and eight radio operators rated as T-4 (the other three cooks were actually cook's helpers). Two motorcyclists, 11 drivers, one message center clerk, eight radio operators, 15 telephone linemen and six scout-observers were T-5. The other two motorcyclists, 10 drivers, 12 telephone linemen, six switchboard operators and six scout-observers rated as T-6.

Source: US Army Adjutant General Table of Organization T/O 7-12 "Infantry Headquarters and Headquarters Company, Regiment Rifle" (Washington DC 1 October 1940).

## Appendix 4.10

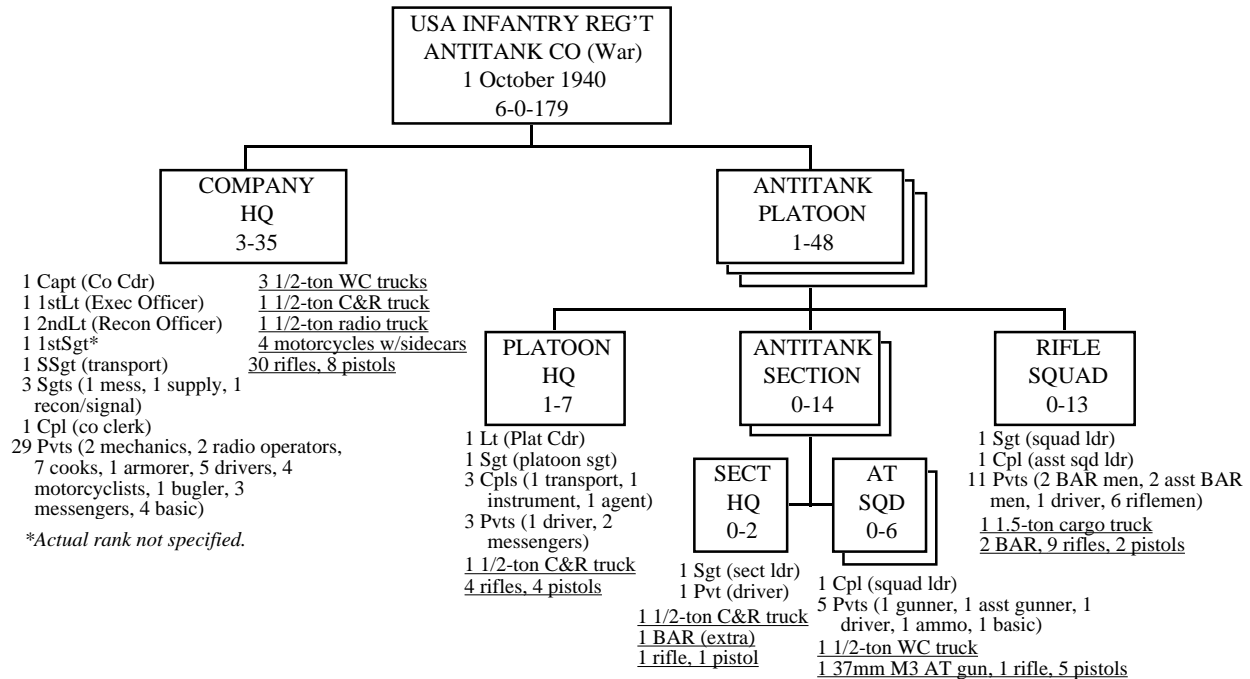

**Notes:**

**Radio Equipment:** Includes one SCR-245 (truck mounted) and five SCR-195 (man-pack). Platoon and company messengers were trained to operate the SCR-195.

**Company Headquarters:** Like the rifle and weapons companies it functioned as a command or captain's group and an administration and supply group. The command group had the company commander, first sergeant, the reconnaissance and signal sergeant, the bugler (also serving as a guide and an observer), two radio operators (for the SCR-245), two messengers (trained to operate the two SCR-195's radios or sound-powered phones) and three drivers (for the radio truck carrying the SCR-245, the headquarters' C&R truck, and its weapons carrier). The administration and supply group would have the company executive officer (lieutenant), the ammunition and supply sergeant, the transport sergeant, the company mess detail, the company clerk, an armorer, two mechanics [who could be attached to the command group during operations], drivers for two weapons carriers (one for personnel), four motorcycle messengers [three could be attached to the antitank platoons], and four basic privates.

**Small Arms Distribution:** Company and platoon headquarters and rifle squad personnel are armed with rifles (or automatic rifles) except for officers, the first sergeant, platoon sergeants, the reconnaissance and signal sergeant, instrument corporals, corporal agents, radio operators, the bugler, and assistant BAR men, who carry pistols. All antitank section personnel carry pistols except for the drivers. Each antitank section carried one extra BAR to defend its vehicles against air attack.

**Enlisted Ranks:** Up to 55 (later reduced to 46) privates in the company could rank as PFC. Two cooks, one motor mechanic, and one radio operator were rated as T-3 technicians. Two more cooks, the armorer (actually the armorer-artificer), the other motor mechanic and the other radio operator rated as T-4 (the other three cooks were actually cook's helpers). Two motorcyclists and 15 drivers were T-5. The other two motorcyclists, 14 drivers and 12 antitank gunners rated as T-6.

**Source:** US Army Adjutant General Table of Organization T/O 7-117 "Infantry Company, Antitank, (Battalion or) Regiment" (Washington DC 1 October 1940).

Appendix 4.11

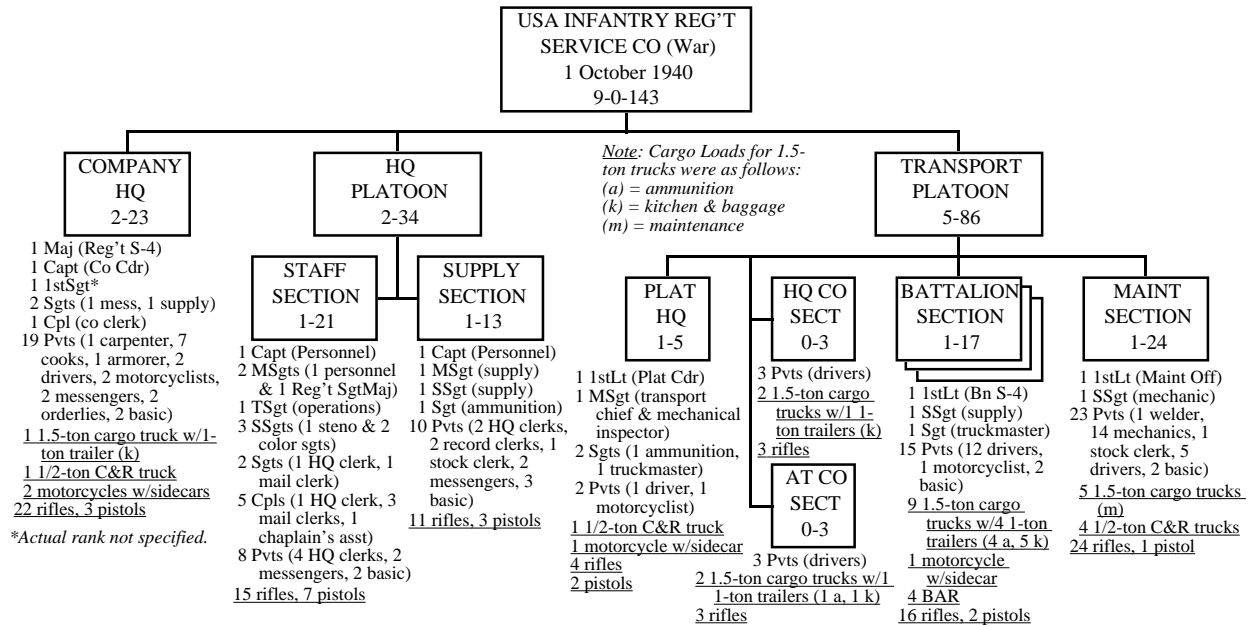

Note:

**Cargo Loads Carried by Transport Platoon Trucks:** In each battalion section, one truck with trailer carries kitchen and baggage equipment for each rifle or weapons company. One truck without a trailer carries kitchen and baggage equipment for the headquarters detachment. One truck carries 180 60mm mortar rounds (60 per active mortar), 16 boxes (4,000) rounds of machinegun ammunition for the LMG's, 5,112 rounds for BAR's, 576 48-round bandoleers for riflemen (enough to issue two per man), 322 .45-caliber rounds (seven per pistol) and 150 hand grenades. One truck (for the weapons company) carries 200 81mm mortar rounds. One truck (with trailer) each in the headquarters and antitank company section carries kitchen and baggage equipment. In the headquarters section the other truck carries mainly signal equipment and some small arms ammunition. The second truck in the antitank company section carries 480 rounds of 37mm ammunition (40 per gun), 4,920 rounds for BAR's, about 25,000 rounds for riflemen (or 192 per man) and 154 pistol rounds (or seven per weapon).

**Small Arms Distribution:** Officers, the first sergeant, master sergeants, the technical sergeant (operations) and all staff sergeants (except one mechanic) carry pistols. One BAR carried for every two trucks (for local air defense).

**Enlisted ranks:** Up to 45 (later reduced to 38) privates in the company could rank as PFC. Five motor mechanics were rated as T-2 technicians. Five motor mechanics, two cooks, two headquarters clerks, one record clerk, one stock clerk, the welder, and the carpenter were rated T-3. Two more cooks, the armorer (actually the armorer-artificer), four motor mechanics, two headquarters clerks and two record clerks rated as T-4 (the other three cooks were actually cook's helpers). Three motorcyclists, 25 drivers and two headquarters clerks were T-5. The other three motorcyclists and 25 drivers rated as T-6.

**Source:** US Army Adjutant General Table of Organization T/O 7-13 "Infantry Company, Service Regiment, Rifle" (Washington DC 1 October 1940). See also The Infantry School "Supply" The Infantry School *Mailing List* Vol. XXII July 41 (Ft Benning Georgia, The US Army Infantry School) pp. 257-60.

### Appendix 4.12

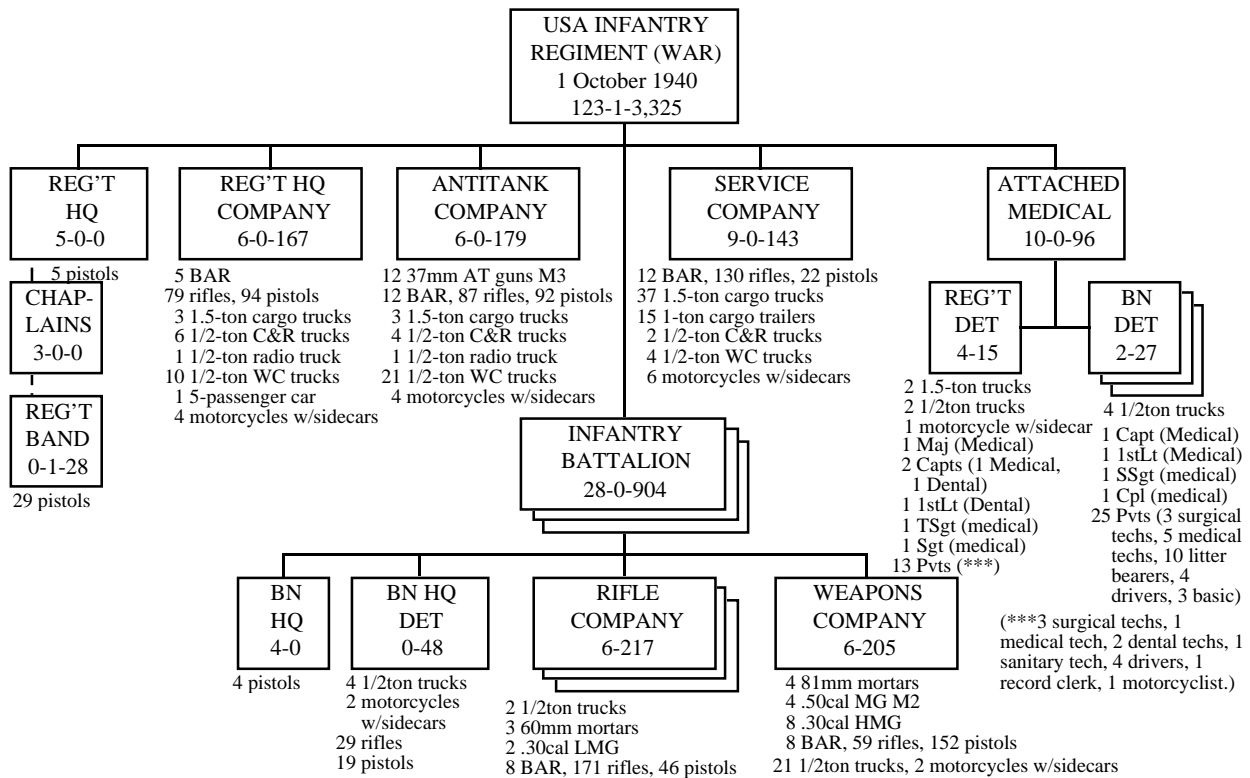

Notes:

Source: US Army Adjutant General T/O 7-11 "Infantry Regiment, Rifle" (Washington DC 1 October 1940).

### Appendix 4.13

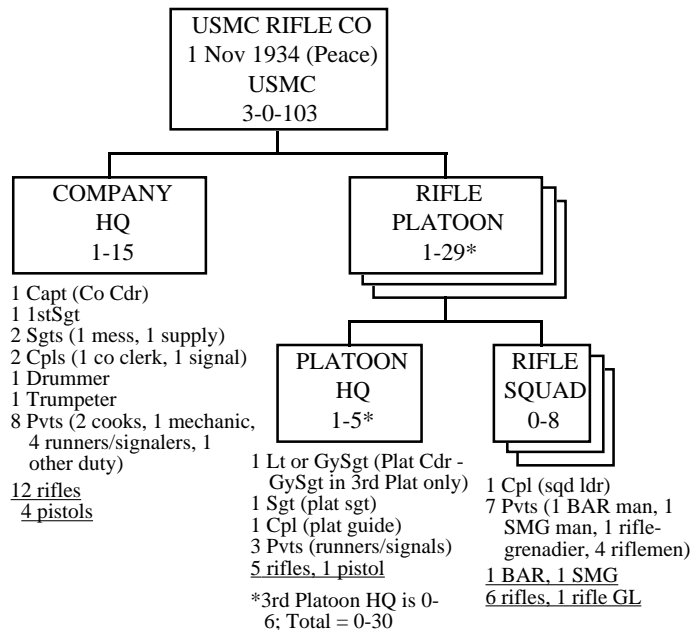

Notes:

**Small Arms:** Officers, the first sergeant and the drummer and trumpeter (formerly field musics) carried pistols.

Source: USMC Organization Table 1P "Rifle Company, Marine Infantry Battalion (peace strength)" (Washington DC 1 Nov. 1934).

**Appendix 4.14**

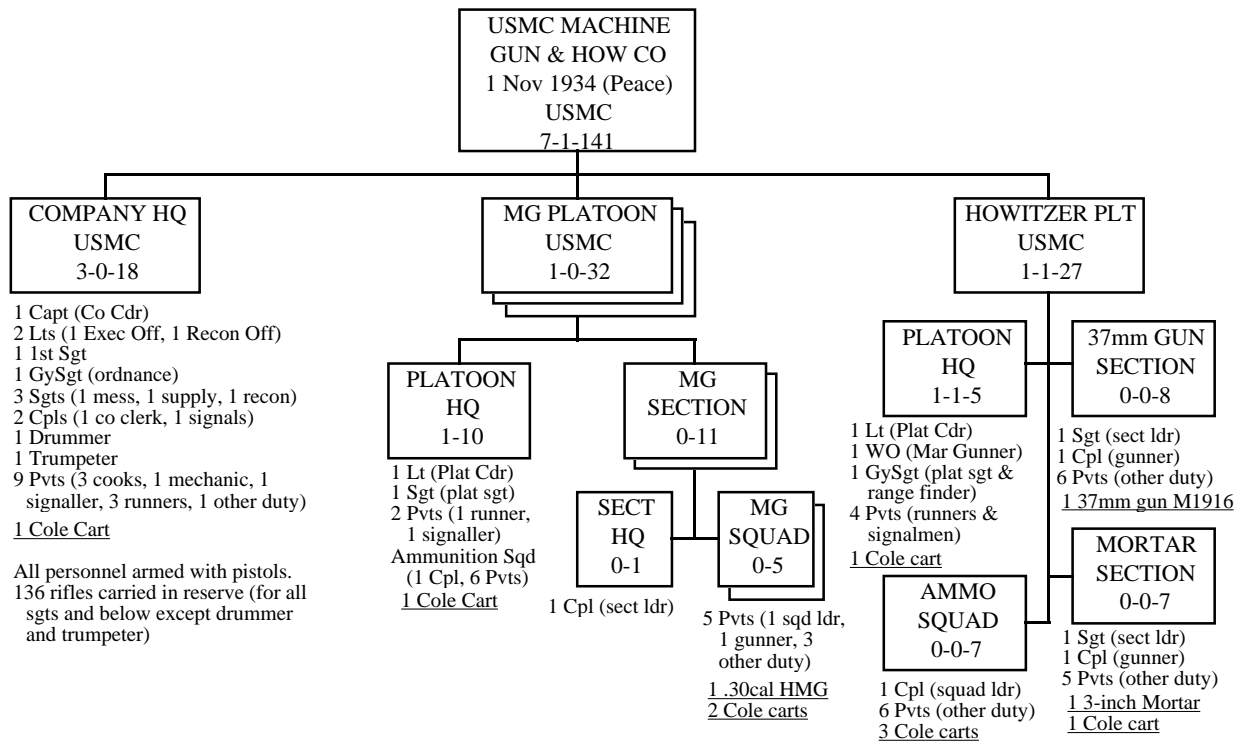

Notes:

Source: USMC Organization Table 3P, "Machinegun and Howitzer Company (peace strength)" (Washington DC 1 Nov. 1934).

**Appendix 4.15**

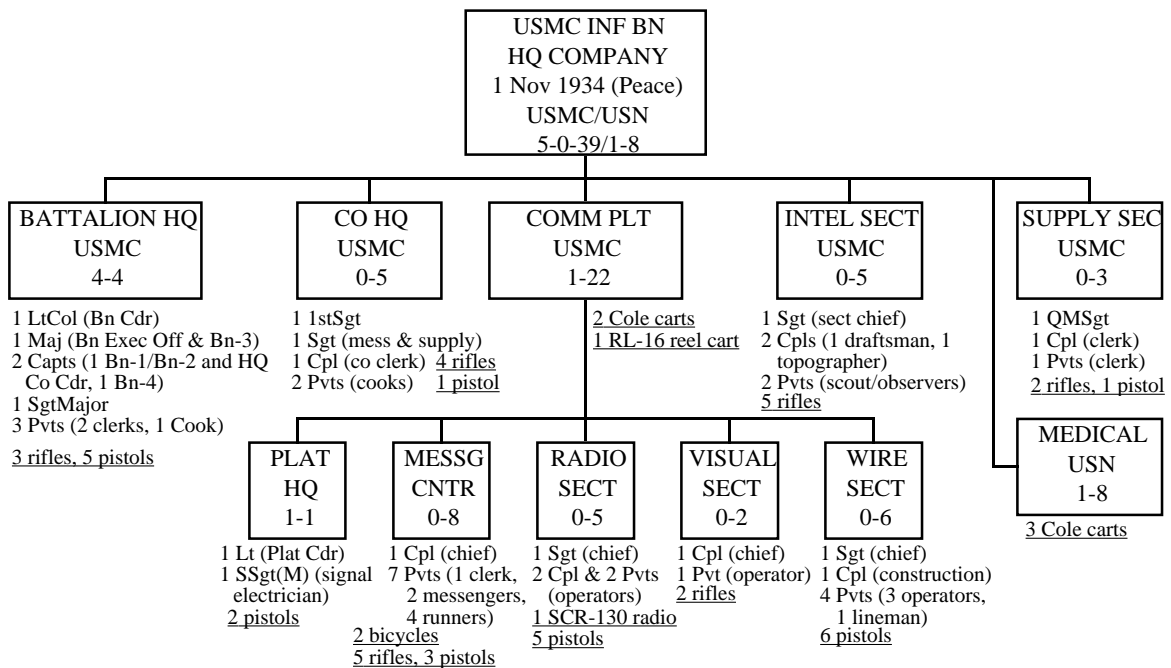

Notes:

**Small Arms:** In the communication platoon the visual section and the clerk and four runners in the message center carried rifles.

Source: USMC Organization Table 4P "Headquarters Company, Marine Infantry Battalion (peace strength)" (Washington DC 1 Nov. 1934).

**Appendix 4.16**

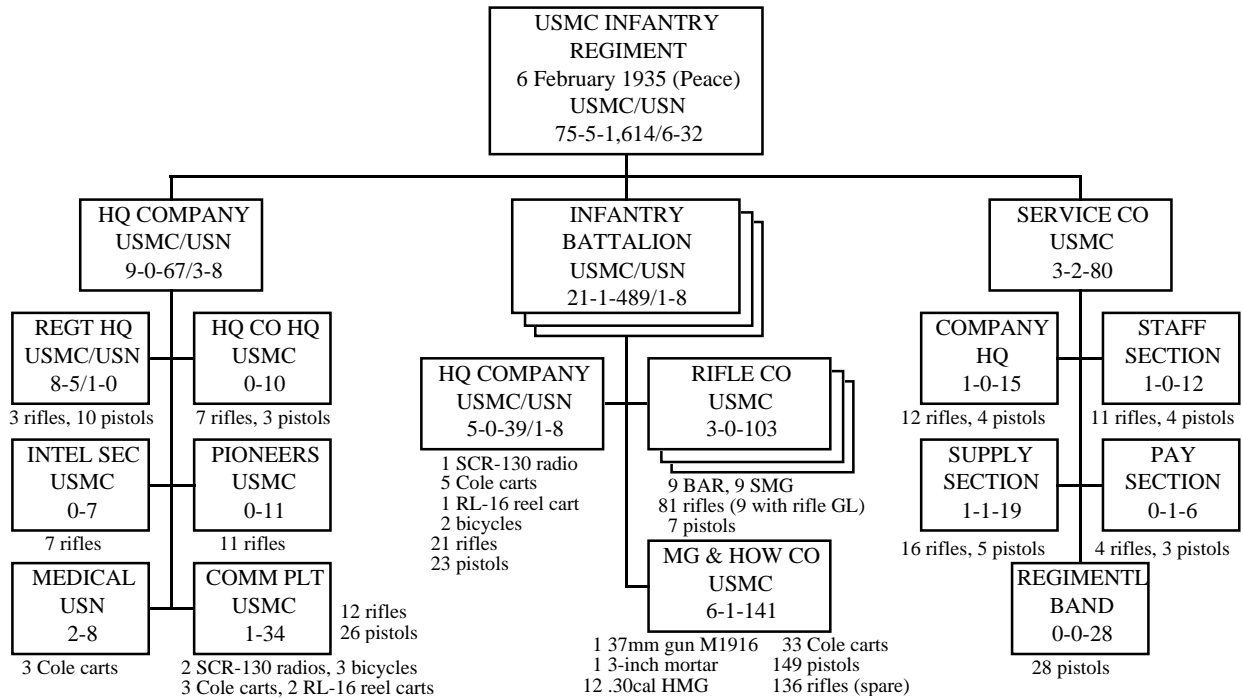

**Notes:**

**Regimental Headquarters:** In peacetime this was supposed to include (but almost never did) the colonel, lieutenant colonel, and a major serving as machinegun, howitzer, and munitions officer. Captains served as adjutant (R-1), intelligence officer (R-2), operations officer (R-3) and supply officer (R-4). There was also a paymaster (captain), a sergeant major, a munitions sergeant (since there was no supply section in the headquarters company), two cooks, a spare (other duty) private, and the chaplain (a Naval officer). The adjutant (R-1) also served as the headquarters company commander.

**Service Company:** The R-4 commanded this unit even though he was part of the regimental headquarters (and is included with that section in the diagram above). The officer shown with the service company headquarters is actually a first lieutenant commissary officer. The service company did not include any organic motor transportation. That was to be attached to it on an "as needed" basis. Attached motor transport units could be separate motor transport sections, platoons or companies. A section (12 men) was built around four trucks or three-ton Holt tractors with cargo trailers. It would also have a 1/2-ton truck, a five-passenger automobile, a water trailers, a motorcycle (with or without a sidecar), and an ambulance. A platoon (with a warrant officer and 38 men) would have 12 trucks or tractors plus four each of the other types. A company (with a captain, a lieutenant, a warrant officer, and 85 men) included 24 trucks or tractors, eight each of most other types, plus fuel, machine shop, and wrecker trucks.

**Small Arms:** In general, Marines ranking as sergeants or below (except for drummers and trumpeters, who would soon revert to being called "field musics" again) would carry rifles. Officers, senior enlisted men, most communication personnel (other than runners, clerks, and visual signalmen), musicians, and machinegun and howitzer company personnel would carry pistols.

**Source:** USMC Organization Tables 6P "Service Company, Marine Infantry Regiment (peace strength)," 7 P "Headquarters Company, Marine Infantry Regiment (peace strength)" and 9P "Marine Infantry Regiment (Peace Strength)" (all Washington, DC 6 Feb 1935).

Appendix 4.17

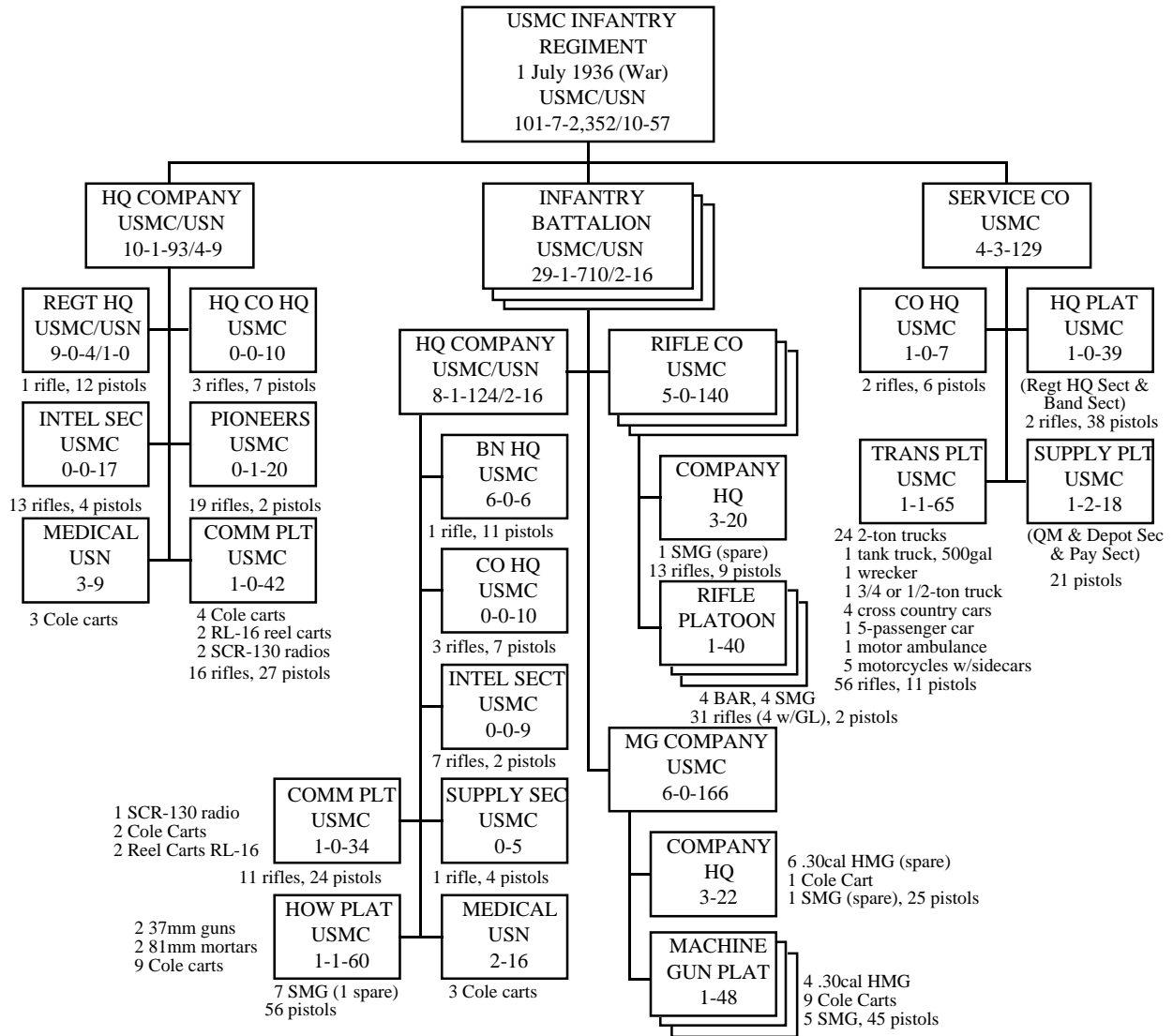

Notes:

Source: USMC Organization Tables, "Marine Infantry Regiment, Marine Brigade (War Strength)" Table No. 21W and subordinate organizations (Wash. DC 1 July 1936).

### Appendix 4.18

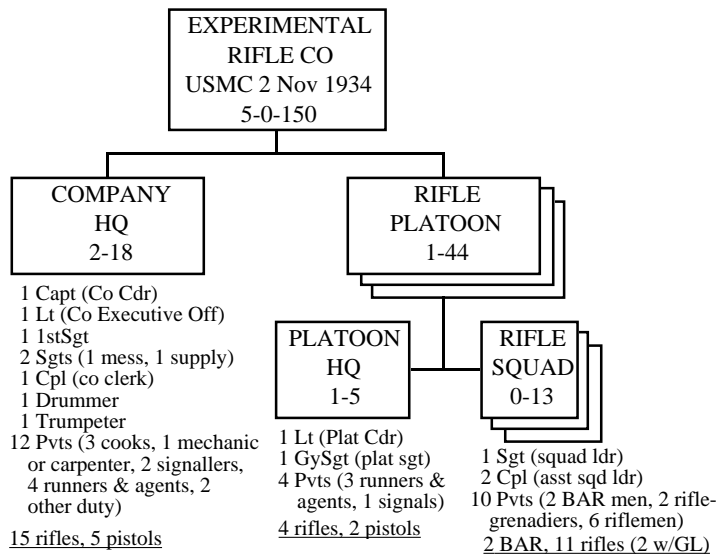

Notes:

Source: Letter from the Major General Commandant to the Commanding General, Fleet Marine Force dated 2 November 1934 on "Experimental Rifle Co (War)" Ellsdran File 2385-30, Copy in the Marine Corps Historical Center Washington DC.

### Appendix 4.19

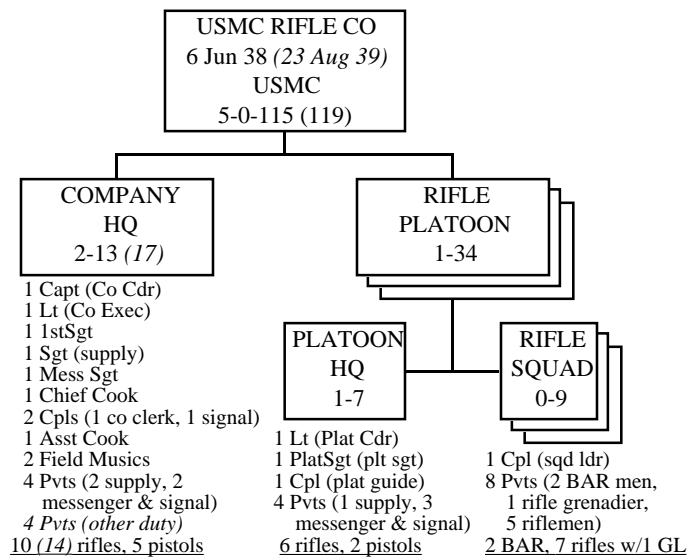

Notes:

The company was authorized four additional "other duty" privates (in wartime only) as of 23 August 1939. A mess corporal could serve as a substitute for the mess sergeant in company headquarters.

Peacetime Manning: Rifle squads were reduced to eight men each. Only one platoon per company would have a guide. Each platoon headquarters would probably lose two privates as well. Company headquarters would lose its executive officer and its mess sergeant and cooks would join a consolidated battalion mess.

Small Arms: Pistols are issued to officers, the first sergeant, the platoon sergeants and the field musics.

Source: USMC Organization Table No. 1, "Rifle Company, Marine Infantry Battalion" (Washington DC 6 June 1938 updated 23 Aug 1939).



Appendix 4.20

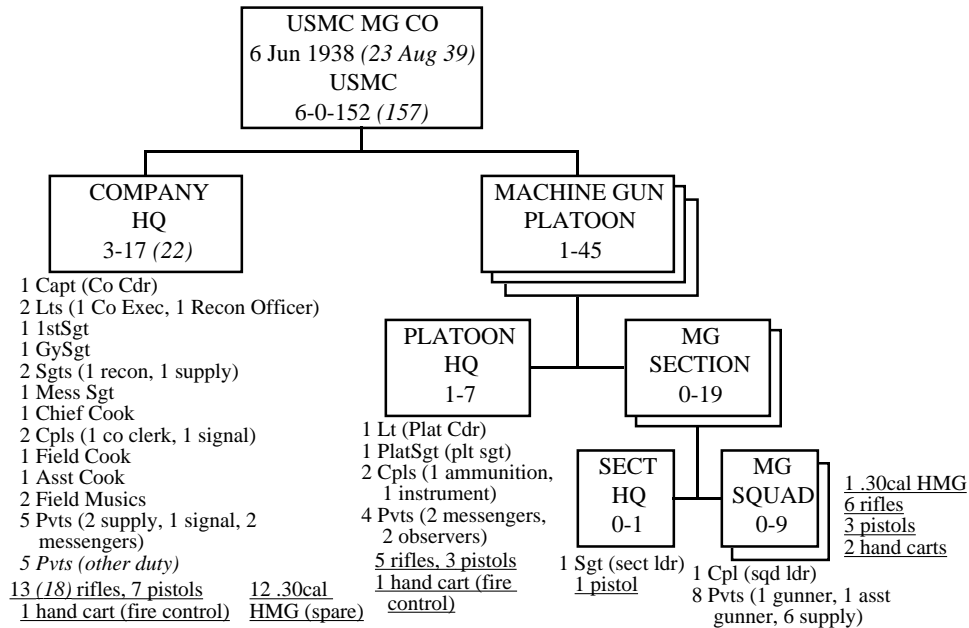

Notes:

The company was authorized (in wartime only) five additional “other duty” privates as of 23 August 1939. A mess corporal could serve as a substitute for the mess sergeant in company headquarters.

**Peacetime Manning:** Only two platoons were actually manned. Even in those platoons, the squads were reduced to eight men each and platoon headquarters lost both its corporals and two privates. Company headquarters lost its executive and reconnaissance officers, its mess sergeant and cooks (transferred to a consolidated battalion mess) and at least two other enlisted men (probably the signal corporal and a private).

**Small Arms:** Officers, the first sergeant, the gunnery sergeant, the platoon sergeants, field musics, instrument corporals, machinegun section and squad leaders and machinegun gunners and assistant gunners carry pistols.

**Source:** USMC Organization Table No. 2, “Machinegun Company, Marine Infantry Battalion” (Washington DC 6 June 1938 updated 23 Aug 1939).

Appendix 4.21

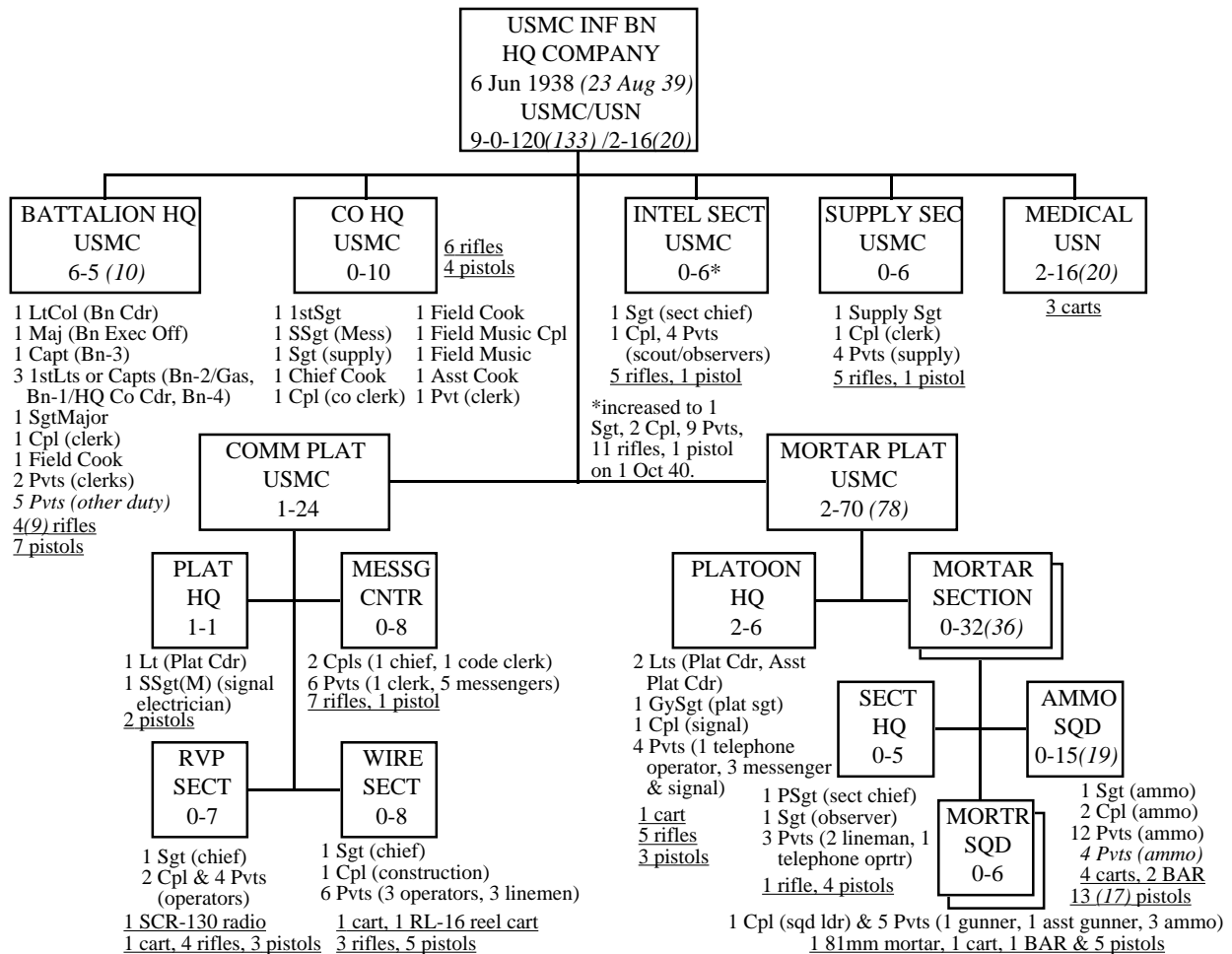

Notes:

Five "other duty privates added to company headquarters and four additional ammunition bearers authorized for each section of the mortar platoon on 23 August 1939. The Intelligence section was augmented as on 1 October 1940.

**Intelligence Section:** This section was originally designed to man a battalion-level observation post. Its expansion on 1 October 1940 added a scout element of one corporal and three privates that could attach a trained scout to each rifle company in the battalion. It also received another private to act as a draftsman and still another to serve as a clerk and recorder.

**Peacetime Manning:** The mortar platoon was reduced to a training unit with an officer, a warrant officer and 36 men. Each mortar squad would have five men and an ammunition squad would have only three. A section headquarters would have a sergeant and two privates. The communication platoon would only lose its lieutenant and two privates. The supply section would have the supply sergeant and one clerk. The intelligence section would consist of just a corporal and two privates. Headquarters company headquarters would include a mess sergeant, two chief cooks, two field cooks, and two assistant cooks to feed the whole battalion but no field musics. Battalion headquarters would get four officers, a sergeant major, and two clerks (a corporal and a private).

**Small Arms:** All officers, the sergeant major, the staff sergeant (mess), supply sergeant, the intelligence section chief, and the field musics carry pistols. In the communication platoon the telephone operators in the wire section, the privates (radio operators) in the RVP section and all message center personnel except the section chief carry rifles. In the mortar platoon, the signal corporal, the messengers and the telephone operators carry rifles. The mortar squad leaders and the ammunition corporals carry BAR's. All other personnel carry pistols.

**Source:** USMC Organization Table No. 3 "Mortar Platoon, Headquarters Company, Marine Infantry Battalion;" No. 4, "Communication Platoon, Headquarters Company, Marine Infantry Battalion;" and No. 5 "Headquarters Company, Marine Infantry Battalion" (all Washington DC 6 June 1938 updated 23 Aug 1939 and 1 October 1940).

Appendix 4.22

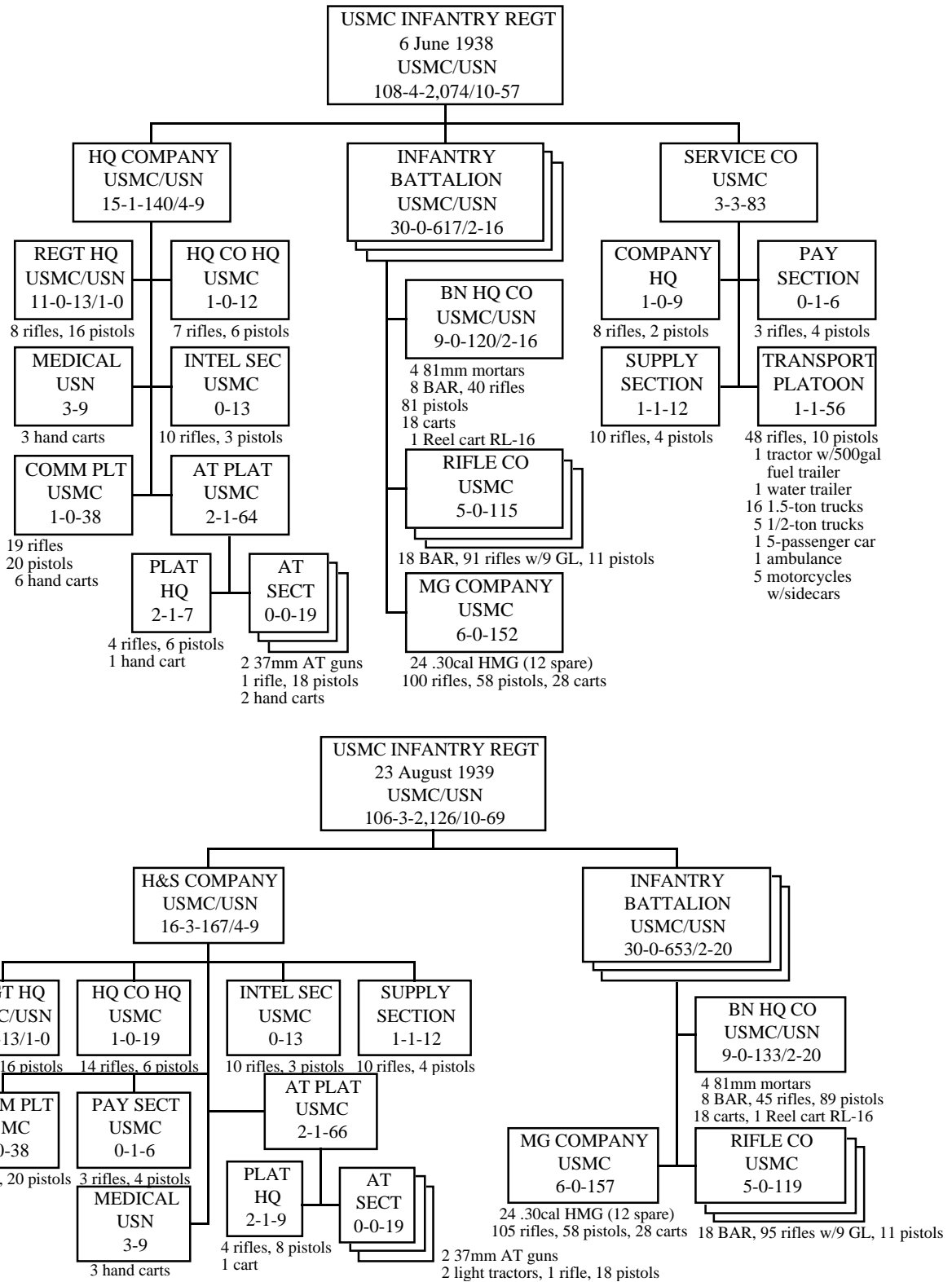

Notes:

Source: USMC Organization Table No. 10, "Marine Infantry Regiment, Infantry Brigade" (Washington DC 6 June 1938 and 23 Aug 1939).

## APPENDIX 5

### Appendix 5.1

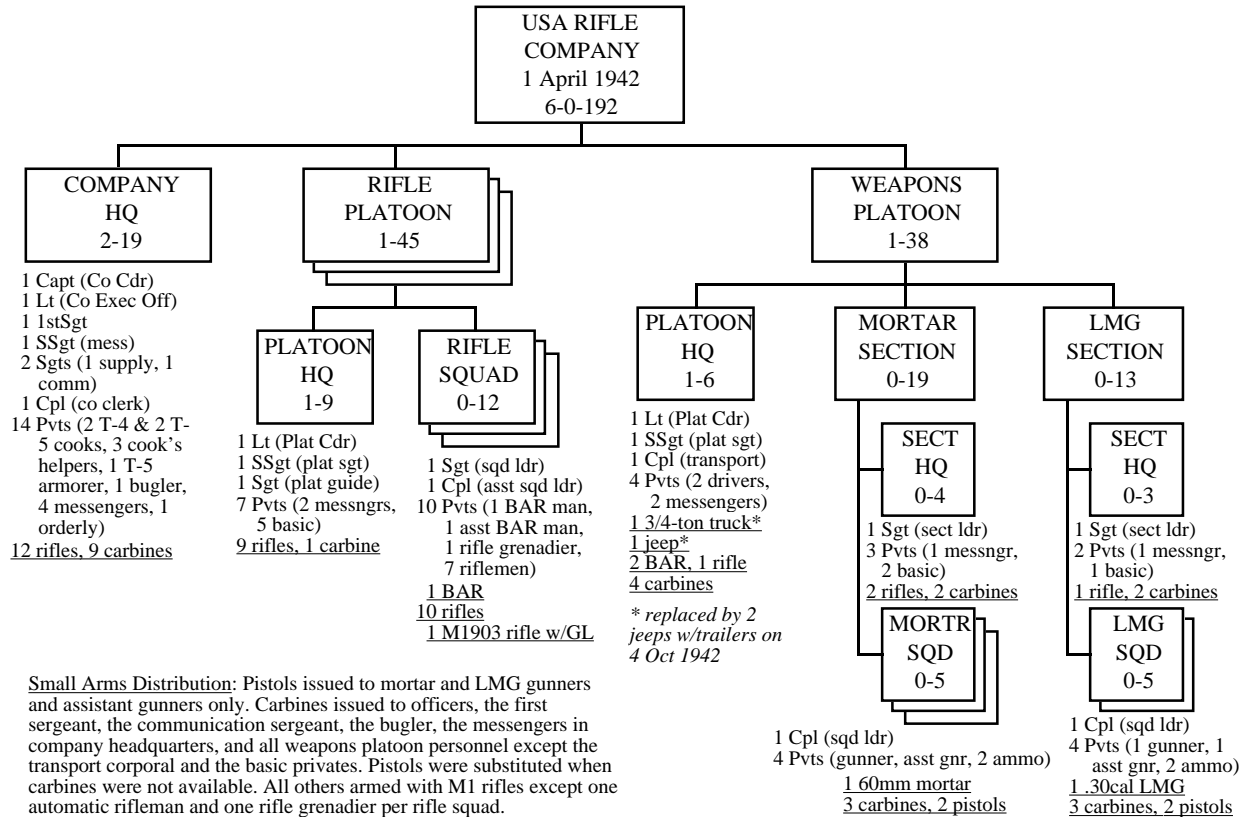

**Small Arms Distribution:** Pistols issued to mortar and LMG gunners and assistant gunners only. Carbines issued to officers, the first sergeant, the communication sergeant, the bugler, the messengers in company headquarters, and all weapons platoon personnel except the transport corporal and the basic privates. Pistols were substituted when carbines were not available. All others armed with M1 rifles except one automatic rifleman and one rifle grenadier per rifle squad.

**Notes:**

**Vehicles:** Two jeeps with trailers replaced the company's 3/4-ton truck and jeep (without trailer) on 4 October 1942.

**Enlisted Ranks:** Just as before the war, the company first sergeant was merely the senior sergeant in the company and the tables of organization did not specify his actual rank. The company's privates included five soldiers with technician ratings and 66 PFC. The T-4 technicians were equivalent to sergeants without command authority (they wore a "T" under a set of sergeant's stripes) and the T-5 technicians corresponded to corporals. The Army no longer used the T-6 rating since there was no functional difference between this rank and that of PFC.

**Source:** War Department Table of Organization 7-17 "Infantry Rifle Company" (Washington DC 1 April 1942).

Appendix 5.2

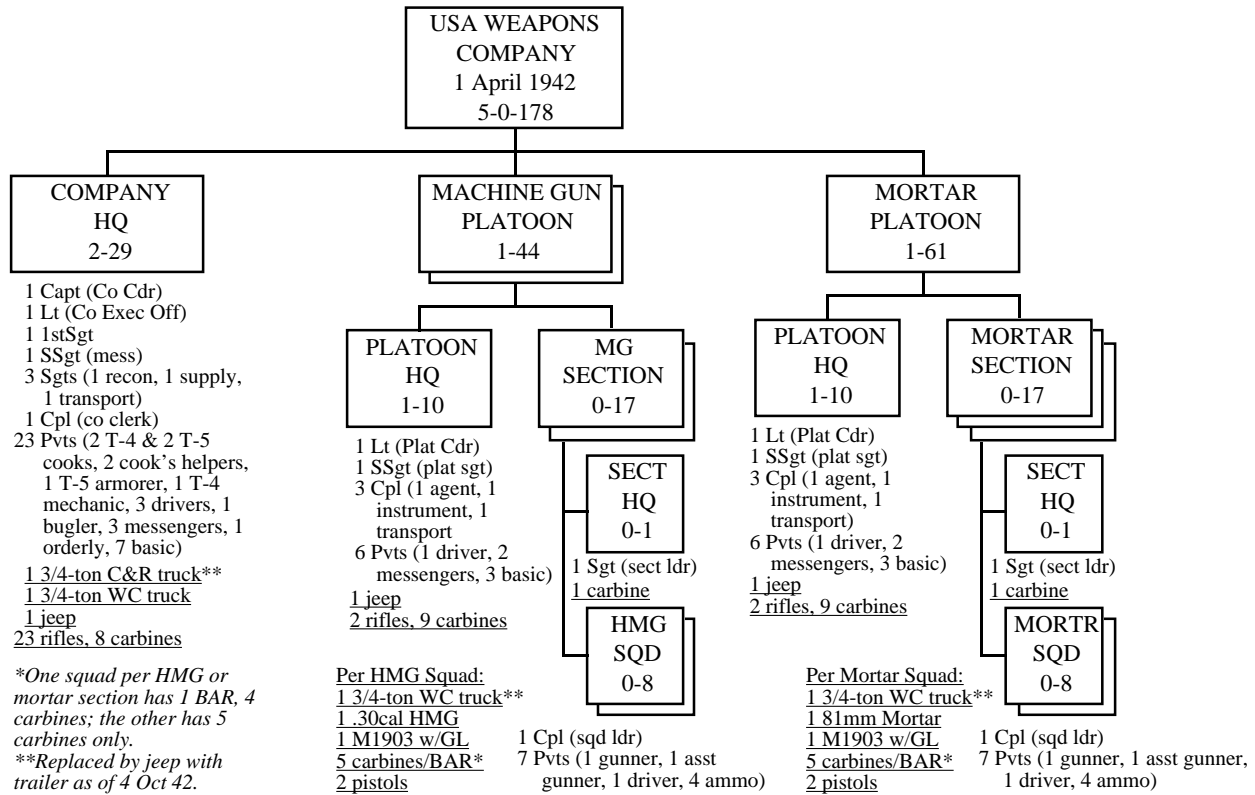

Notes:

Vehicles: Jeeps with trailers replaced most of the company's 3/4-ton trucks on 4 October 1942.

Small Arms: All personnel in the company headquarters carried rifles except the officers, the first sergeant, the reconnaissance sergeant, the bugler, and three messengers (who had carbines). All personnel in the machinegun and mortar platoons carried carbines except gunners and assistant gunners (who carried pistols), the drivers and transport corporals in platoon headquarters (who carried M1 rifles) and the mortar and machinegun squad leaders (who carried M1903 rifles with grenade launchers). Also, one driver per mortar or machinegun section carried a BAR.

Enlisted Ranks: See the comments under Appendix 5.1. The company's privates included six technicians and 59 PFC.

Source: War Department Table of Organization 7-18 "Infantry Heavy Weapons Company" (Washington DC 1 April 1942).

### Appendix 5.3

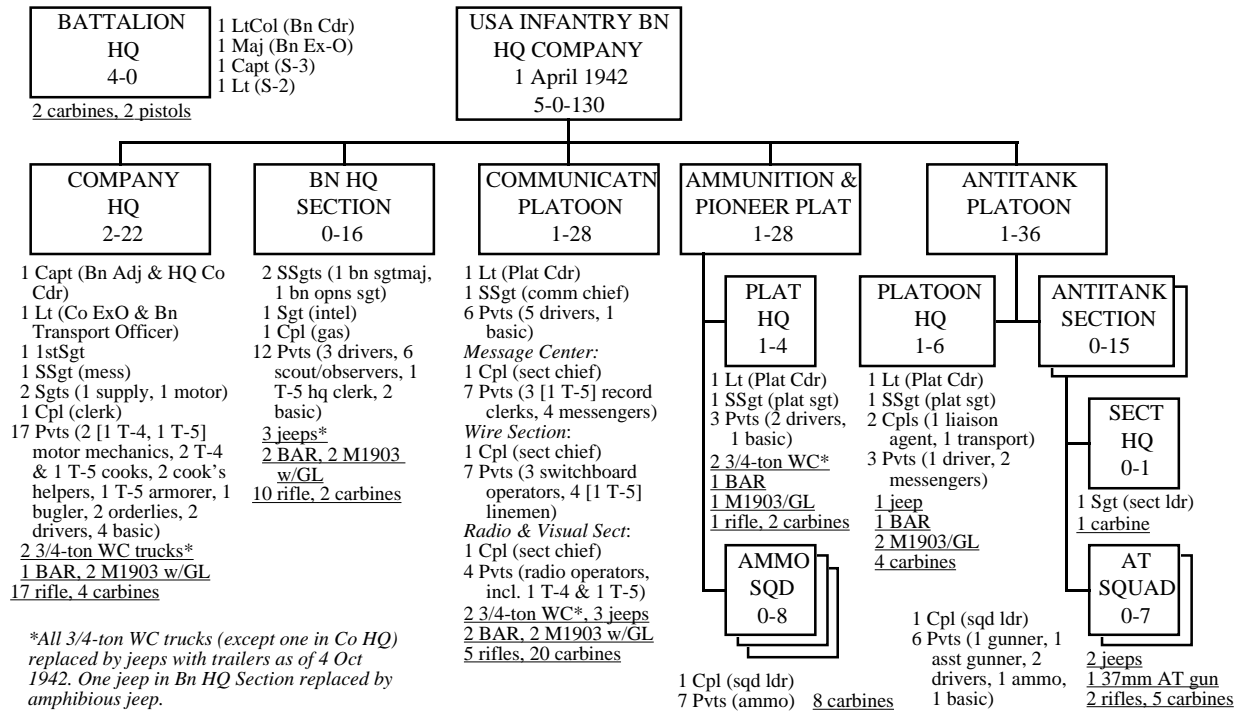

**Notes:**

**Small Arms:** Field grade officers (the major and lieutenant colonel) and the 37mm antitank gunners and assistant gunners carried pistols. All drivers carried either a BAR, or an M1903 rifle with M1 grenade launcher (except for one driver in the communication platoon and the drivers in the 37mm antitank squads who carried M1 rifles). In addition, the company bugler, the headquarters clerk in the battalion headquarters section, and both corporals in the antitank platoon headquarters also carried M1903 rifles with grenade launchers. All other personnel in the company headquarters and the battalion headquarters section carried rifles except the officers, first sergeant, two staff sergeants and motor sergeant (who carried carbines). All personnel in the communication, pioneer and antitank platoons carried except drivers and communication platoon messengers.

**Enlisted Ranks:** See the comments under Appendix 5.1. The company's privates included 11 technicians and 41 PFC.

**Source:** War Department Table of Organization 7-16 "Headquarters and Headquarters Company, Infantry Battalion" (Washington DC 1 April 1942).

## Appendix 5.4

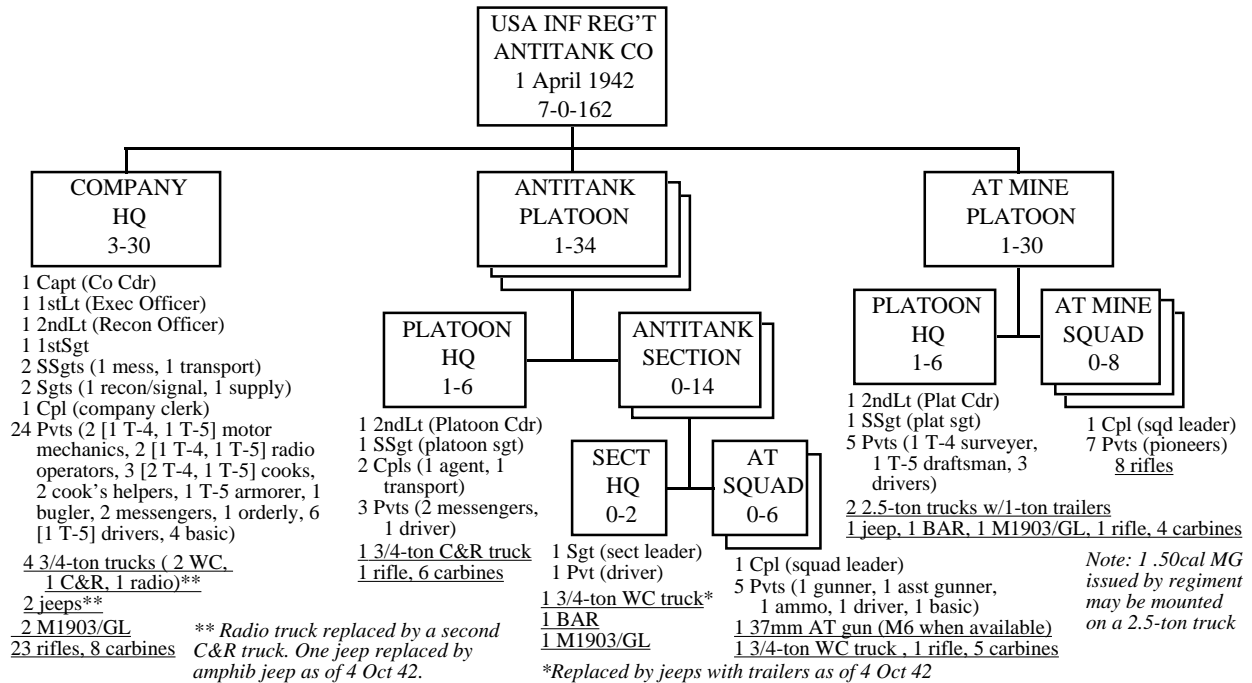

**Notes:**

**Weapons:** The company was to receive the M6 37mm gun as soon as it was available. The M6 was the same as the M3 towed gun except that it was bolted to the rear bed on a 3/4-ton (unarmored) truck and could thus serve as a self-propelled weapon. The gun had a bullet-proof shield and could rotate 360 degrees but it could not be dismounted and fired from the ground. The truck was unarmored and the gun normally fired to the rear since the gun could not obtain full depression to the front. The idea was that the gun could open fire from a vantage point and then quickly retreat to avoid enemy counter-fire. In North Africa these vehicles proved to be all but useless since the 37mm gun was too light to be effective at the ranges at which "shoot and scoot" tactics might have been used successfully. Towed 37mm guns could at least be dug in and made much less conspicuous.

**Small Arms:** All company headquarters personnel carried M1 rifles except the officers, first sergeant, reconnaissance sergeant, bugler and messengers (who carried carbines) and the two radio operators (who carried M1903 rifles with grenade launchers). All personnel in the antitank platoons carried carbines except the section leaders (who had M1903 rifles with grenade launchers) and the drivers (who either carried M1 rifles or BAR's). In the antitank mine platoon one driver carried a BAR, a second had an M1903 rifle and the third had an M1 rifle. Other platoon headquarters members carried carbines while the squads carried rifles.

**Enlisted Ranks:** See the comments under Appendix 5.1. The company's privates included 11 technicians and 49 PFC.

**Source:** War Department Table of Organization 7-117 "Infantry Antitank Company" (Washington DC 1 April 1942).

## Appendix 5.5

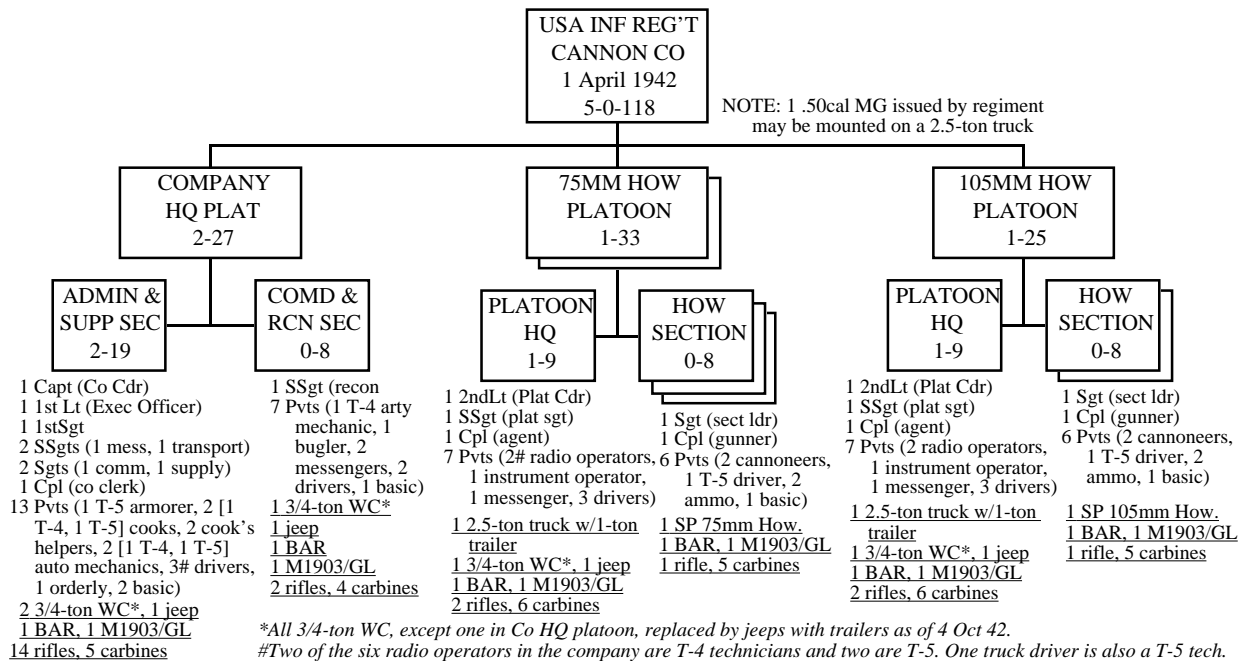

**Notes:**

**Weapons:** All “howitzers” were mounted on half-track carriers. The 75mm weapons were usually M1897 field guns rather than actual howitzers and they could serve as antitank as well as artillery weapons. The T-19 105mm howitzer-armed half-tracks were badly overloaded. Each half-track self-propelled weapon could actually accommodate only five members of the eight-man section it was authorized. The two ammunition handlers passed ammunition from the platoon’s 2.5-ton truck to their respective section half-track and rode in whatever other vehicle might have space for them. The basic private had no specified duties.

**Small Arms:** BAR issued to one driver each in the administrative and supply section and the command and reconnaissance section of the headquarters platoon, to one driver in each howitzer platoon headquarters and to the driver in each howitzer section. The issue of the M1903 rifles with grenade launchers was the same except that in the howitzer sections the section leaders carried them. All other personnel in the howitzer platoons carried carbines except the basic privates in the howitzer sections and one driver and the corporal (agent) in each platoon headquarters (who had M1 rifles). In the company headquarters platoon the officers, first sergeant, staff sergeant (transport), reconnaissance sergeant, communication sergeant, the bugler and two messengers carried carbines.

**Enlisted Ranks:** See the comments under Appendix 5.1. The company’s privates included 19 technicians and 30 PFC.

**Source:** War Department Table of Organization 7-14 “Infantry Cannon Company” (Washington DC 1 April 1942).



## Appendix 5.6

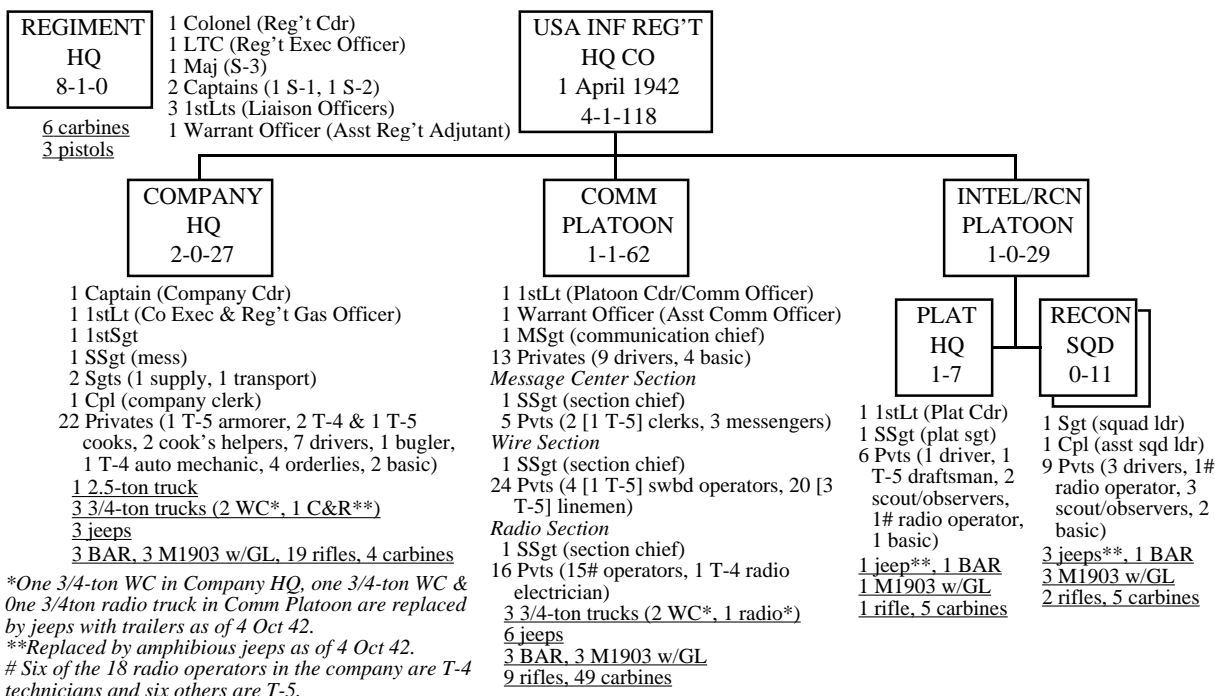

### Notes:

**Small Arms:** The draftsman in the I&R platoon headquarters and the assistant squad leader in each I&R squad carried M1903 rifles with grenade launchers. All other M1903 rifles and all BAR's issued to truck drivers. In the company headquarters the officers, first sergeant and the bugler carried carbines. Six drivers carried M1903 rifles of BAR's. All other personnel had M1 rifles. In the communication and I&R platoon a total of 10 drivers carried BAR's or M1903 rifles. The assistant I&R squad leaders and the draftsman in the I&R platoon headquarters, also carried M1903 rifles. The two message center clerks and three drivers in the communication platoon and all the basic privates in both platoons carried M1 rifles. All the remaining members of these platoons carried carbines. In the regimental headquarters the field grade officers (colonel, lieutenant colonel and major) carried the pistols.

**Enlisted Ranks:** See the comments under Appendix 5.1. The private men in the company included 24 technicians and 35 PFC.

**Source:** War Department Table of Organization 7-12 "Headquarters and Headquarters Company, Infantry Regiment" (Washington DC 1 April 1942).

## Appendix 5.7

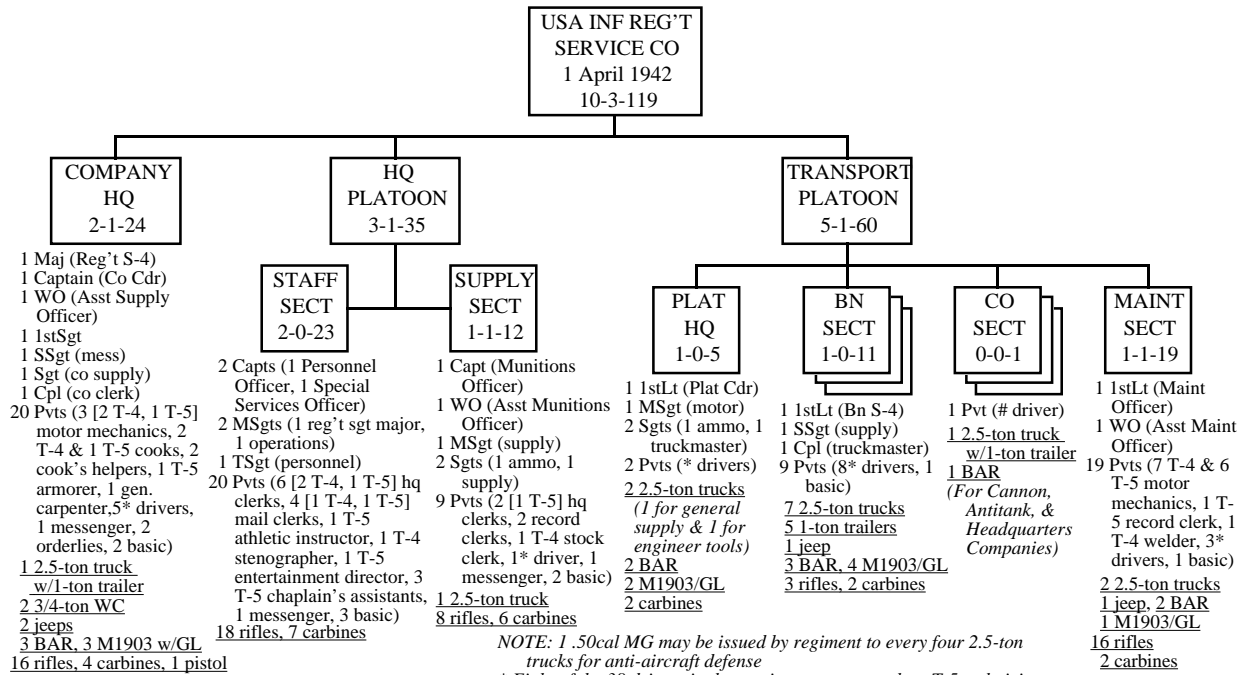

**Notes:**

**Small Arms:** The sergeant (supply) and two drivers in company headquarters, the two sergeants in the transportation platoon headquarters, the corporal and three drivers in each battalion section, and one driver in the maintenance section carried M1903 rifles with grenade launchers. Most of the remaining drivers carried BAR's. All other personnel carried M1 rifles except for officers, warrant officers, master sergeants, technical sergeants, the first sergeant, staff sergeants (supply), the ammunition and supply sergeants in the supply section, the stenographer in the staff section and all messengers. All of these exceptions, other than the major (S-4, who carried a pistol), carried carbines.

**Enlisted Ranks:** See the comments under Appendix 5.1. The private men included 43 technicians and 23 PFC.

**Source:** War Department Table of Organization 7-14 "Service Company, Infantry Regiment" (Washington DC 1 April 1942).

## Appendix 5.8

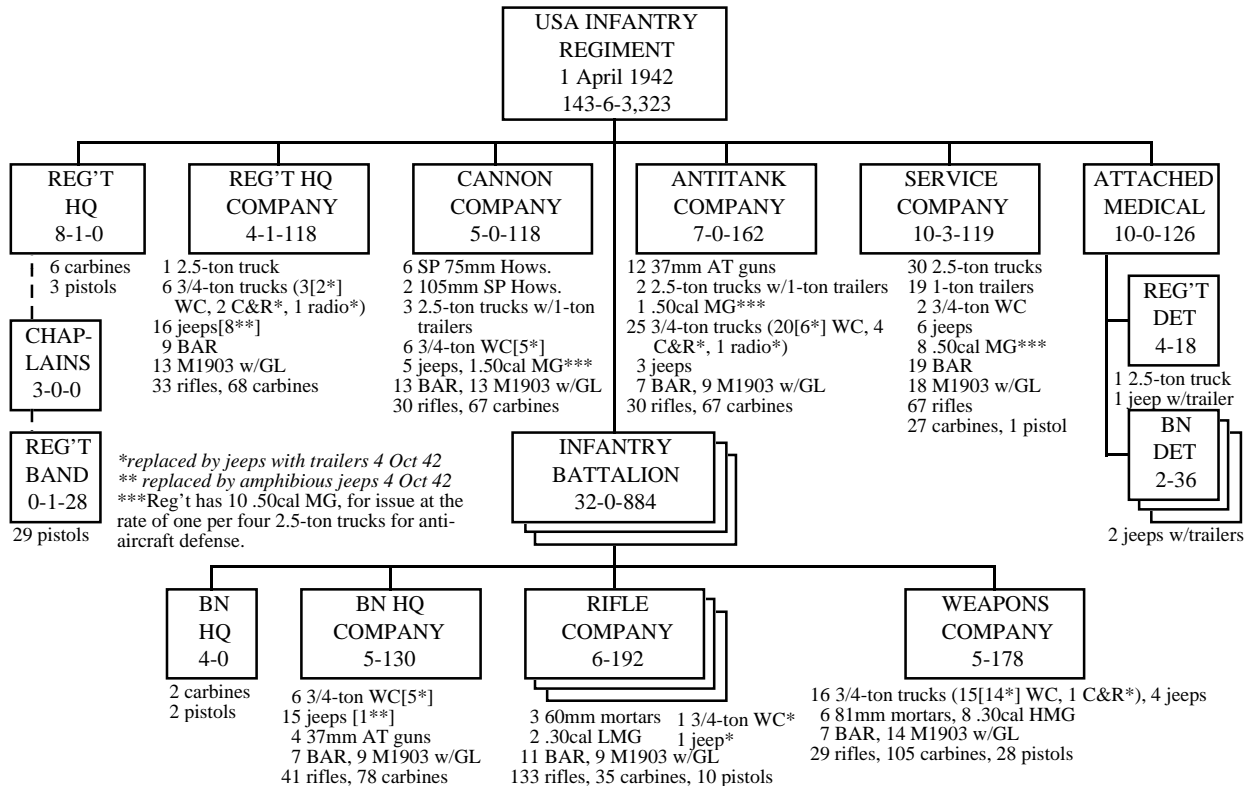

Notes:

Attached Medical:

**Regimental Detachment:** Had one major (regimental surgeon), two captains (one medical and one dental), a first lieutenant (dental), a technical sergeant (medical), a sergeant (medical), nine privates (surgical) (including three company medics for the cannon company and three for the antitank company), one private (medical), two dental technicians (T-5), one private (sanitary), one record clerk (T-5), and two drivers.

**Each Battalion Detachment:** Had one captain, one first lieutenant, one staff sergeant (medical), one corporal (medical), 15 privates (surgical) (including three company medics for each rifle or weapons company and one for the antitank platoon in the headquarters company), two medical technicians, 12 litter bearers, two drivers, and three basic privates.

Out of 54 privates (surgical) in the medical detachment, nine were T-4 technicians and 14 were T-5. Out of seven privates (medical) two were T-5 technicians.

**Regimental Band:** An infantry regiment, when authorized, can include a regimental band. When a band exists the regimental adjutant (S-1) commands it and it is attached to the service company for mess, supply and administrative purposes. A band consists of a warrant officer, a technical sergeant, a staff sergeant, seven T-4 technicians, eight T-5 technicians and 11 PFC, all armed with pistols. Tables of organization published after 1942 did not include infantry regimental bands since the Army had adopted a policy of supplying one band per division and attaching it to division headquarters.

Source: War Department Table of Organization 7-11 "Infantry Regiment" (Washington DC 1 April 1942).

## Appendix 5.9

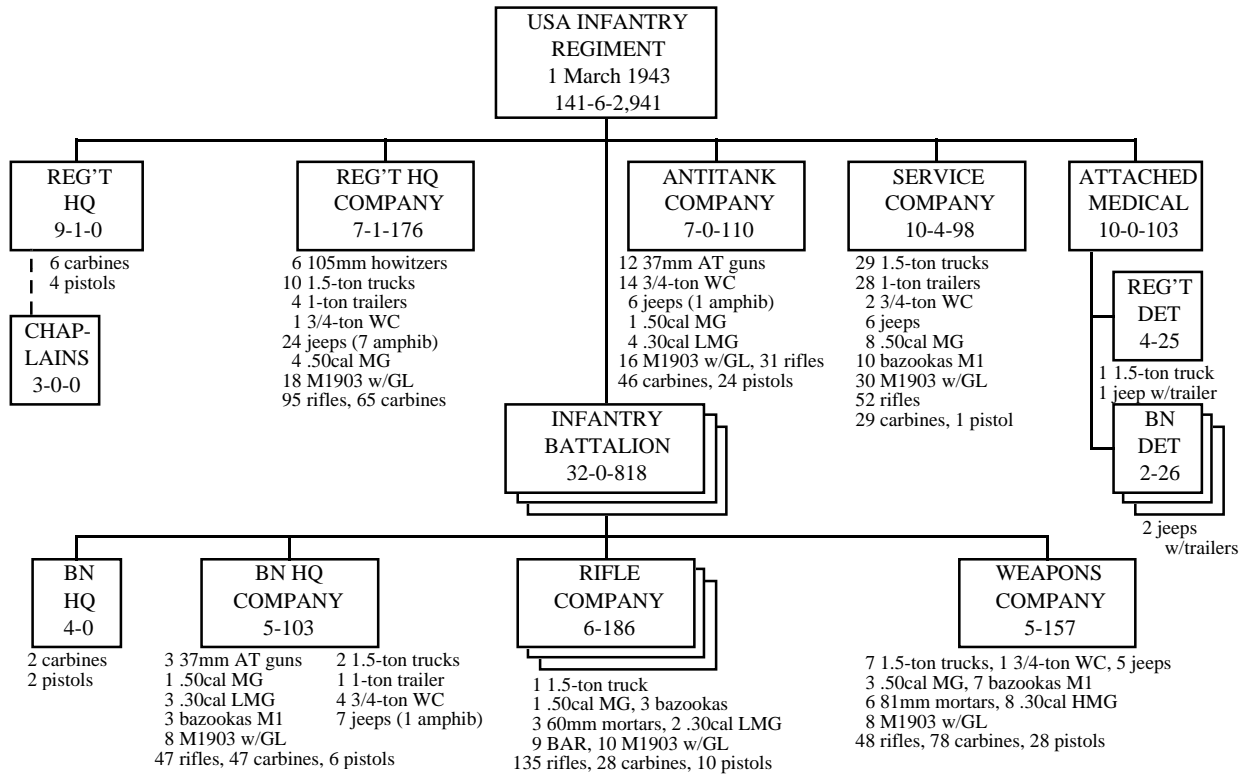

**Notes:**

These tables were General McNair's initial attempt to reduce the 1942-series divisions to a more manageable scale in terms of their men and equipment but without sacrificing combat power. These tables raised such strong objections from the combat theaters that the Army Ground Forces later accepted a set of modified tables, dated July 1943 under which some of the cuts made from the 1942 tables were restored. As a result most regiments transitioned directly from the April 1942 tables to the July 1943 tables during late 1943 or early 1944.

**Principal changes from the 1942 Tables:** Overall, .50cal machineguns replaced the BAR in the convoy defense role and 1.5-ton trucks replaced 2.5-ton trucks and many jeeps and 3/4-ton trucks in the transportation and weapons carrier roles. Bazookas began to displace M1903 rifles with grenade launchers in the antitank defense role. Outside of this, few changes were made to the rifle and weapons companies. Antitank platoons were cut to three 37mm guns each but the antitank company boosted to four platoons to keep it at 12 guns. The antitank mine platoon was eliminated and the cannon company was reduced to three platoons with two M3 towed 105mm howitzers each and absorbed by the regimental headquarters company. Numerous small personnel economies were made throughout the regiment but generally not in the rifle or weapons companies. Basic privates were removed from smaller units and concentrated in company headquarters to be assigned duties by the company commander. On 7 April 1943, the rank of the regimental I&R platoon commander was increased from first lieutenant to captain.

**Source:** War Department Table of Organization 7-11 "Infantry Regiment" (Washington DC 1 March 1943).

Appendix 5.10

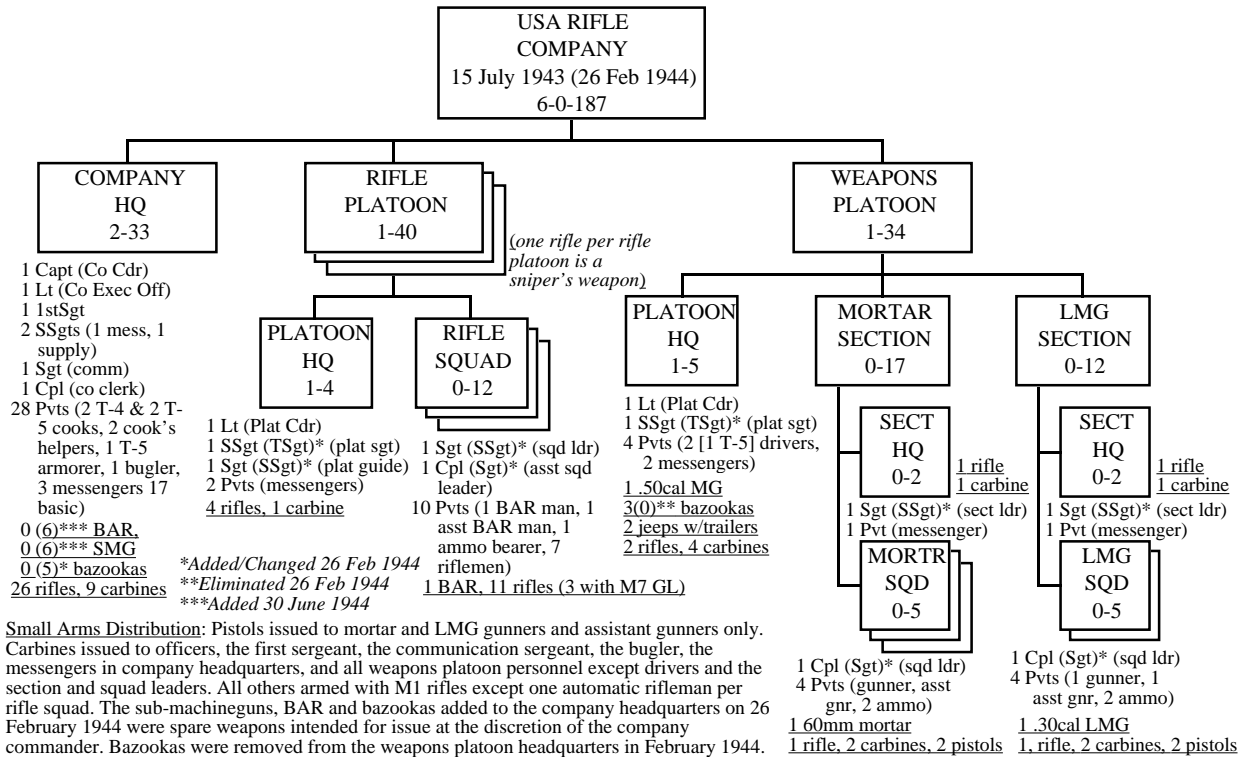

**Small Arms Distribution:** Pistols issued to mortar and LMG gunners and assistant gunners only. Carbines issued to officers, the first sergeant, the communication sergeant, the bugler, the messengers in company headquarters, and all weapons platoon personnel except drivers and the section and squad leaders. All others armed with M1 rifles except one automatic rifleman per rifle squad. The sub-machineguns, BAR and bazookas added to the company headquarters on 26 February 1944 were spare weapons intended for issue at the discretion of the company commander. Bazookas were removed from the weapons platoon headquarters in February 1944.

Notes:

**Weapons:** By February 1944, up to three riflemen per rifle squad carried M7 grenade launchers for their rifles. The M7 launcher plus the new M1C sniper rifle (issued to one marksman in each rifle platoon) meant that the M1903 rifle could be retired both as a grenade launcher and a sniper's weapon (though, due to their accuracy and popularity with the sniper community many M1903A4 sniper rifles remained in service through the Korean War).

**Enlisted Ranks:** See the comments under Appendix 5.1. On 26 February 1944, assistant rifle squad leaders and mortar and LMG squad leaders increased in rank from corporal to sergeant. Rifle squad leaders increased in rank from sergeant to staff sergeant. Platoon sergeants increased in rank from staff sergeant to technical sergeant. The company's private included six technicians and 64 PFC (104 PFC after February 1944).

**Communication Equipment:** For its own internal radio communication requirements the company had six SCR-536 hand-held radios and normally issued one to each rifle or weapons platoon commander, one to the company commander and one to company headquarters. The company's parent battalion communication would supply one SCR-300 man-pack radio (without an operator) for communication with battalion headquarters. Wire equipment was less extensive and included two CE-11 reels with phones attached, enough to communicate with an observation post. The battalion communication platoon would provide sufficient equipment to enable wire communication between company and battalion headquarters. A rifle company would also have five signal lamps, three panel sets (for signaling aircraft) and five flag sets (for semaphore).

**Source:** War Department Table of Organization 7-17 "Infantry Rifle Company" (Washington DC 15 July 1943 and 26 February 1944 plus changes dated 30 June 1944).

Appendix 5.11

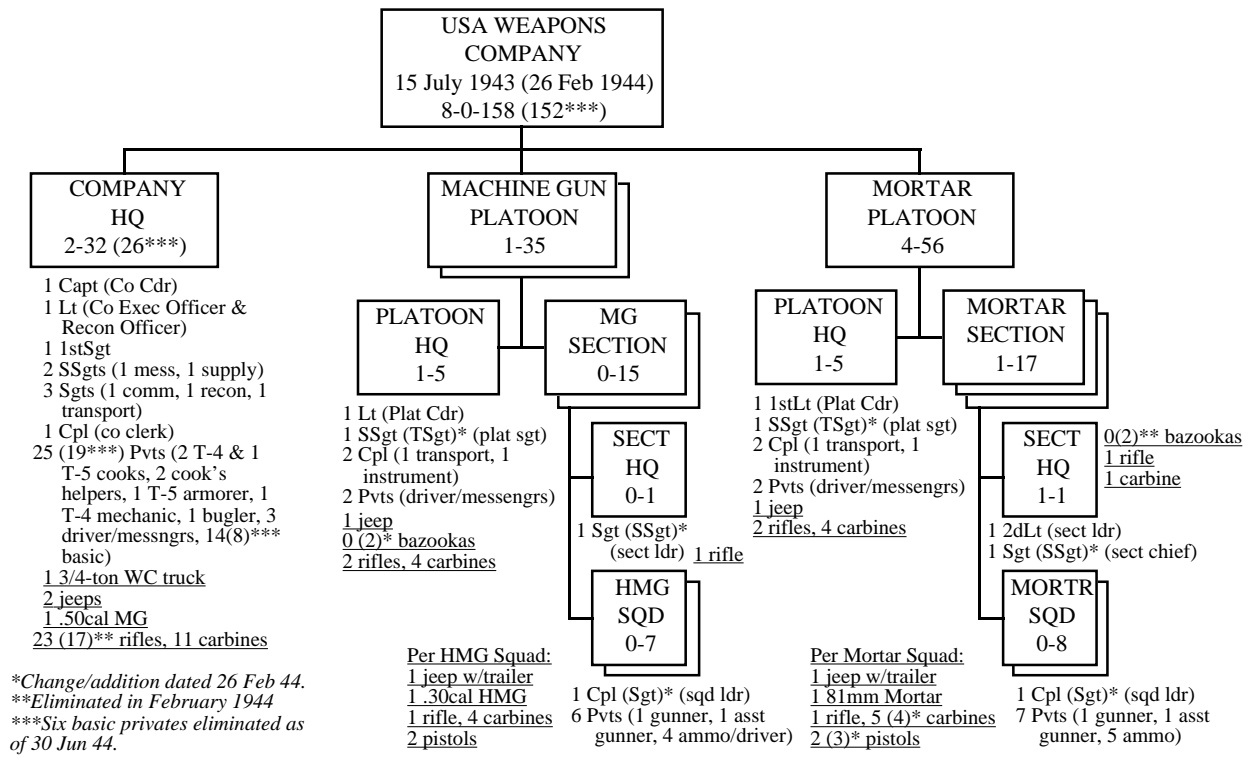

\*Change/addition dated 26 Feb 44.  
 \*\*Eliminated in February 1944  
 \*\*\*Six basic privates eliminated as of 30 Jun 44.

Notes:

**Small Arms:** In the company headquarters all personnel carry rifles except the officers, first sergeant, the mess and supply staff sergeants, the communication and reconnaissance sergeants, the armorer and the three messengers who carry carbines. In the machinegun and mortar platoons all personnel carry carbines except mortar and machinegun gunners and assistant gunners who carry pistols and squad leaders, sergeant or staff sergeant section leaders or chiefs and the transport and instrument corporals who carry rifles. After 26 February 1944 one ammunition bearer per mortar squad carried a pistol in lieu of a carbine.

**Enlisted Ranks:** See the comments under Appendix 5.1. On 26 February 1944 the Army increased the machinegun and mortar squad leaders from corporal to sergeant; section leaders or chiefs from sergeant to staff sergeant and platoon sergeants from staff sergeant to technical sergeant. The privates in the company included five technicians and 48 PFC (79 PFC after February 1944).

**Communication Equipment:** For its own internal radio communication requirements the company had six SCR-536 "hand-held radios. It normally issued one to each machinegun platoon and two or three to the mortar platoon and kept one or two at company headquarters. The company's parent battalion communication platoon would supply one SCR-300 man-pack radio (without an operator) for communication with battalion headquarters. The company did not have any field telephone equipment of its own but the battalion communication platoon would at least have ensured that the weapons company headquarters had a telephone connection with battalion headquarters. The company also had four signal lamps plus flag and panel sets.

**Source:** War Department Table of Organization 7-18 "Infantry Heavy Weapons Company" (Washington DC 15 July 1943 and 26 February 1944 plus changes dated 30 June 1944).

## Appendix 5.12

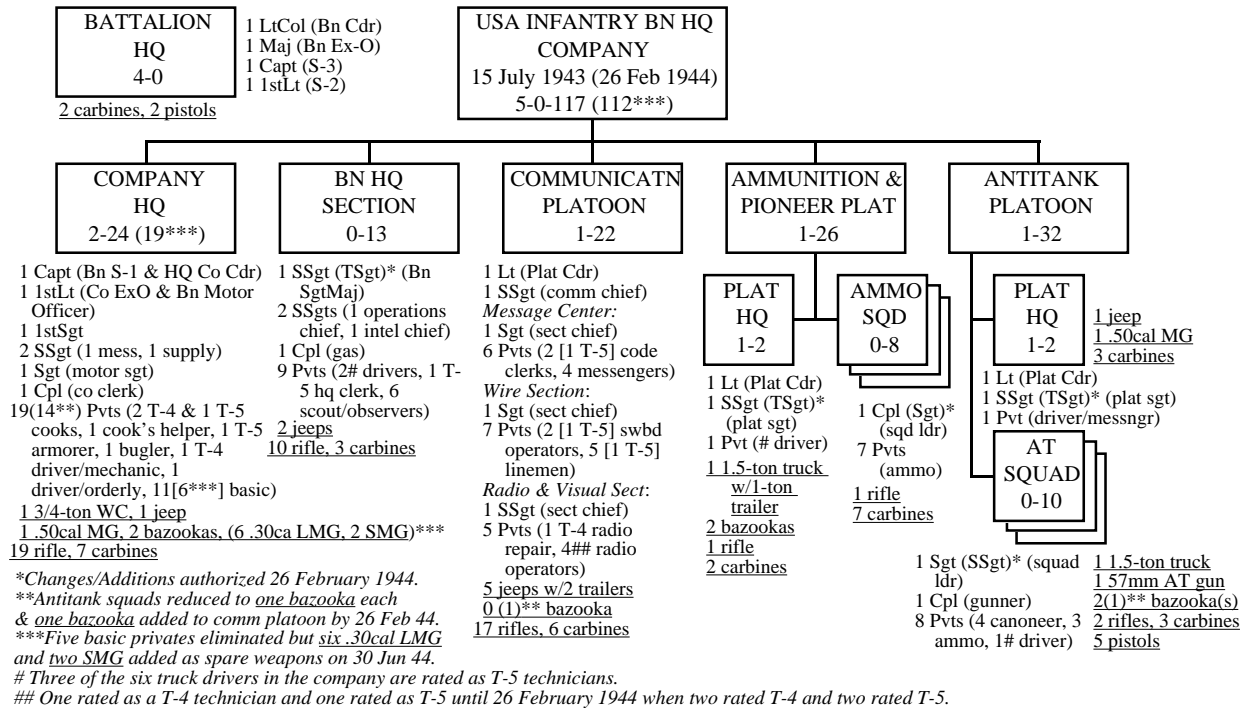

**Notes:**

The .50-caliber machinegun shown with the antitank platoon headquarters was intended for mounting on one of the antitank squad trucks to provide convoy anti-aircraft defense.

**Small Arms:** In the battalion headquarters, the company headquarters, the battalion headquarters section and the communication platoon the lieutenant colonel and major carried pistols and the other officers, the first sergeant, all staff sergeants (except the message center chief) and technical sergeants, the bugler, the orderly, and all messengers carried carbines. All others carried rifles. In the pioneer and antitank platoons antitank gunners and cannoneers carried pistols. Squad leaders and drivers (except for the driver/messenger in the antitank platoon headquarters) carried rifles. All other personnel carried carbines.

**Additional Duties:** One T-4 cook ran the battalion officers' mess. The mechanic in company headquarters also drove the 3/4-ton truck. The orderly also drove the jeep. Five communication platoon personnel as designated by the platoon commander (but probably including three of the messengers) also drove the platoon's five jeeps. The driver in each antitank squad was also an ammunition bearer.

**Communication Equipment:** The radio section of the communication platoon held one long-range SCR-284 (probably the ground version but carried in a jeep) and six SCR-300 man-pack radios. Two men manned the SCR-284, which communicated with higher headquarters. The SCR-300's were for the battalion's internal tactical net. The radio section manned two of them and issued the other four to the rifle and heavy weapons company headquarters. Wire and telephone equipment included eight CE-11 reel equipments (with phones), eight EE-8 telephones, a BD-71 switchboard and a TG-5 telegraph set. Two signal lamps and flag sets were also available.

**Enlisted Ranks:** See the comments under Appendix 5.1. On 26 February 1944 the battalion sergeant major and the antitank and pioneer platoon sergeants were increased in rank from staff sergeant to technical sergeant. Antitank squad leaders rose from sergeant to staff sergeant and pioneer squad leaders rose from corporal to sergeants. Of the company's private men 15 were technicians (17 after 26 February 1944) and 34 were PFC (55 were PFC after February 1944).

**Source:** War Department Table of Organization 7-16 "Headquarters and Headquarters Company, Infantry Battalion" (Washington DC 15 July 1943 and 26 February 1944 plus changes dated 30 June 1944)

Appendix 5.13

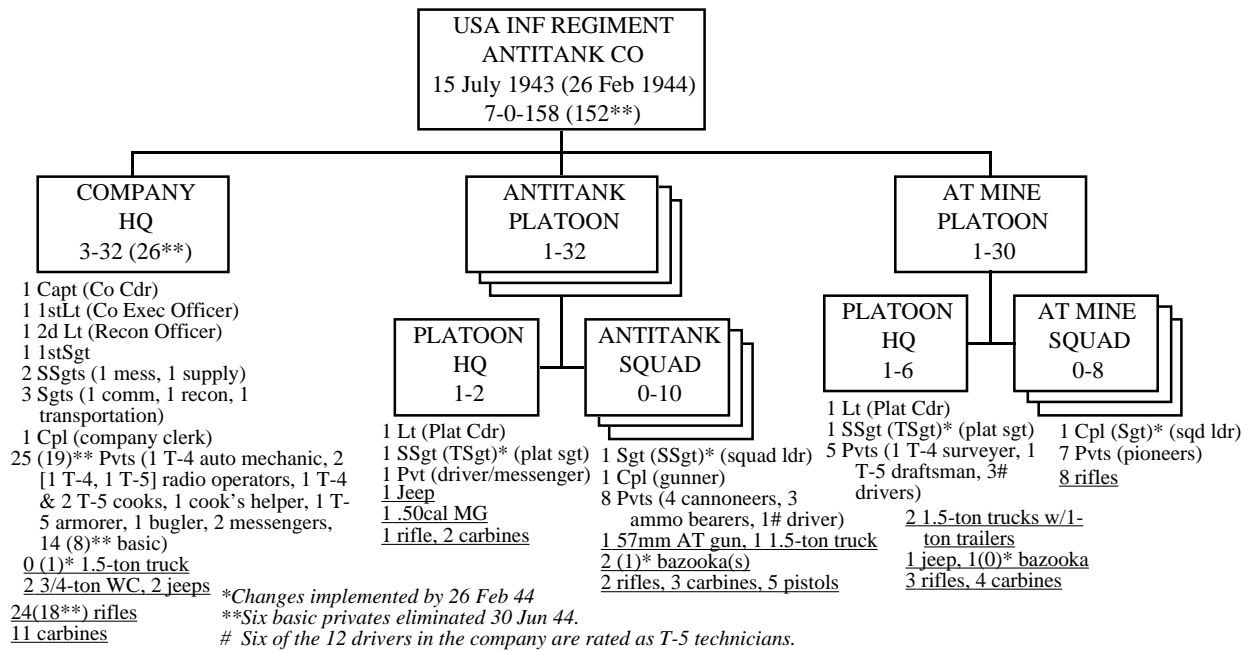

Notes:

The .50-caliber machinegun in each antitank platoon headquarters was intended for mounting on one on the antitank squad trucks to provide convoy anti-aircraft defense. In February 1944 the War Department reduced the total number of bazookas in the company from seven to three. This was mainly to put more bazookas in the rifle companies (where they were most needed) without increasing the total number of bazookas in the regiment.

**Small Arms:** In the company headquarters the officers, the first sergeant, the staff sergeants, the reconnaissance and communication sergeants, the bugler and the two messengers carried carbines. All others carried rifles. In the antitank and antitank mine platoons, the gunners and cannoneers carried pistols. Drivers, antitank squad leaders, and members of the antitank mine squads carried rifles. All others carried carbines.

**Additional Duties:** In the company headquarters the bugler and auto mechanic also drove 3/4-ton trucks. The two messengers also drove jeeps. The drivers in the antitank squads also served as ammunition handlers.

**Communication Equipment:** For communication with higher headquarters the company operated one SCR-284 long-range radio mounted in a 3/4-ton truck (driven by the bugler) and operated by the company's two radio operators. For inter-communication among its subordinate elements the company also had five SCR-300 man-pack radios. The company headquarters and each platoon headquarters would employ one of these radios. The company's wire and telephone equipment included 12 CE-11 reel units (with phones attached). There were also two flag sets and 15 panel sets.

**Enlisted Ranks:** See the comments under Appendix 5.1. On 26 February 1944 the authorized rank of antitank mine squad leaders was raised from corporal to sergeant. Antitank squad leaders rose from sergeant to staff sergeant and platoon sergeants went from staff sergeant to technical sergeant. The company's private men included 15 technicians and 49 PFC (80 PFC after February 1944).

**Source:** War Department Table of Organization 7-117 "Infantry Antitank Company" (Washington DC 15 July 1943 and 26 February 1944 plus changes dated 30 June 1944).



## Appendix 5.14

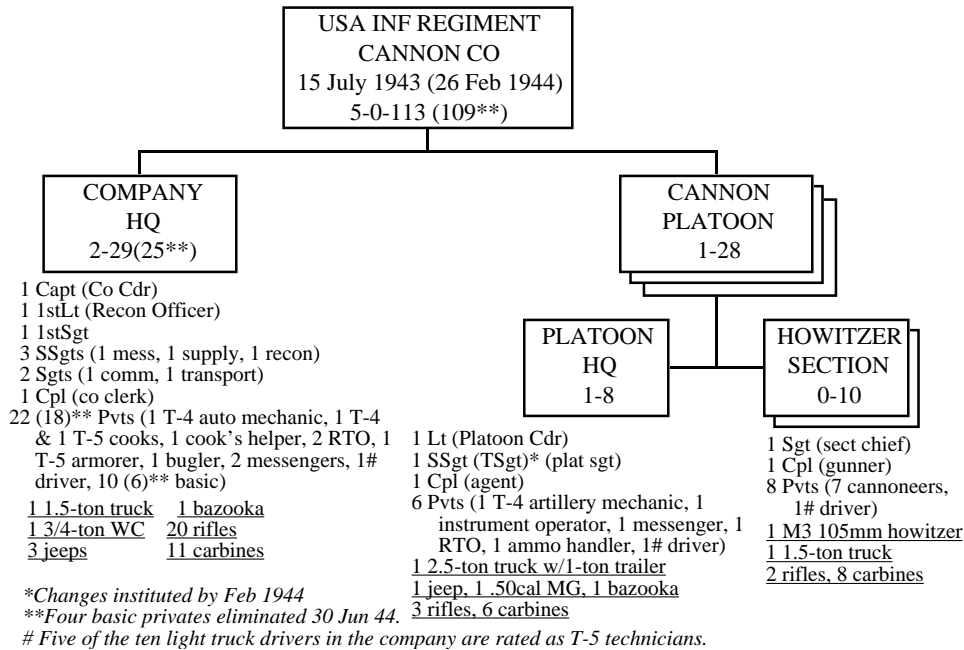

**Notes:**

The cannon platoons were largely the same as they had been in March 1943 when they were part of the regimental headquarters company. However the War Department increased each howitzer section from eight men to ten and added an RTO to the platoon headquarters.

**Weapons:** The cannon company used the M3 105mm howitzer, rather than the M2A1 used by the infantry division's artillery. Originally intended for use by airborne troops the M3 fired the same projectiles as the M2A1 but only to a maximum range of just under 7,600 meters vice the 11,160-meter range of the M2A1. However the M3 howitzer weighed only half as much as the M2A1 or about 2,500 pounds in action vice nearly 5,000. This enabled it to be towed by a 1.5-ton truck, a much more economical and less conspicuous vehicle. Though the original concept for the cannon company called for weapons capable of direct fire in support of the infantry neither the M2A1 nor the M3 was well suited for such a role. In combat the M3's generally served as conventional (if short-ranged) indirect fire artillery, just like the M2A1's with division artillery.

**Small Arms:** In the company headquarters the officers, the first sergeant, the reconnaissance staff sergeant, the communication and transport sergeants, the bugler, the two messengers and the two radio-telephone operators (RTO) carried carbines. All others carried rifles. In the howitzer platoons section chiefs, the corporal (agent) in each platoon headquarters, the artillery mechanics and the drivers all carried rifles. All others carried carbines.

**Additional Duties:** Messengers and the bugler also drove jeeps. The auto mechanic also drove the company's 3/4-ton truck.

**Communication Equipment:** The company's five radio-telephone operators (RTO) operated its five SCR-300 man-pack radios. There was no other radio equipment but telephone equipment included 12 CE-11 reel equipments with phones, six EE-8 telephones and a BD-71 switchboard. Each gun section had two signal lamps and one more lamp was at company headquarters.

**Enlisted Ranks:** See the comments under Appendix 5.1. From 26 February 1944 the howitzer platoon sergeants were to rank as technical sergeants rather than staff sergeants. The company's private men included 12 technicians and 33 PFC (55 after February 1944).

**Source:** War Department Table of Organization 7-14 "Infantry Cannon Company" (Washington DC 15 July 1943 and 26 February 1944 plus changes dated 30 June 1944); for data on M2A1 and M3 105mm howitzers see Ian V. Hogg, *British and American Field Artillery of World War II* (New York, Hippocrene Books 1978) pp. 59-63.

Appendix 5.15

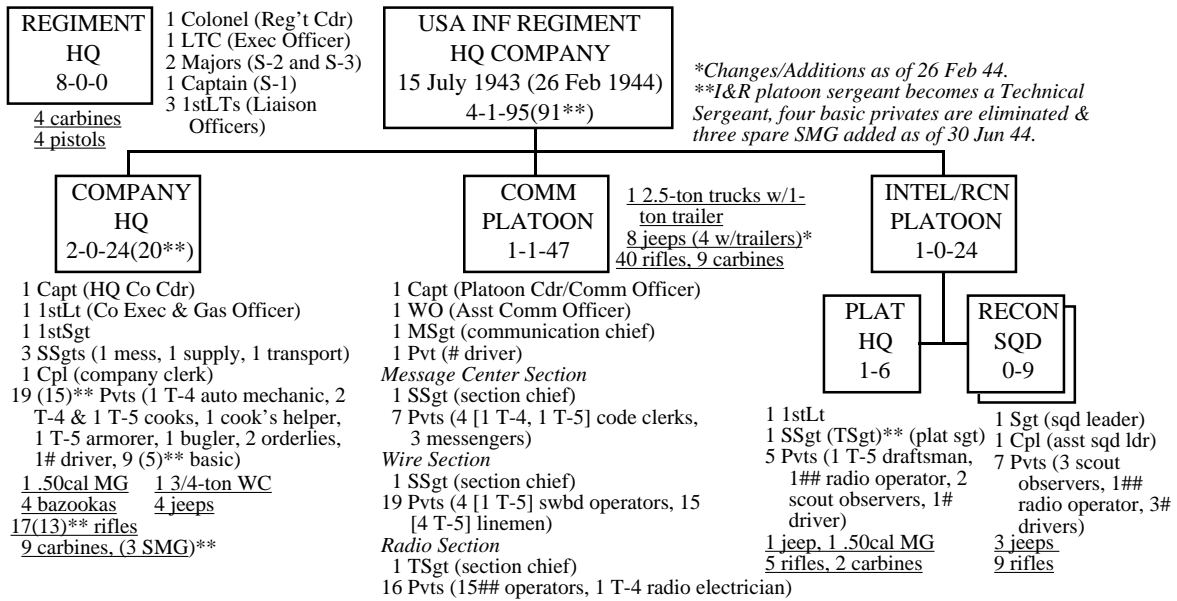

*Note: One T-4 cook is for the regimental officer's mess.  
# Three of the nine light truck drivers in the company are rated as T-5 technicians.  
## Until 24 February 1944, six of the 18 radio operators in the company are rated as T-4 technicians and six are rated as T-5. After 24 February 1944, eight radio operators are rated T-4 and ten are rated T-5.*

Notes:

**Small Arms:** Field grade officers (majors and higher) carried pistols. All other officers, the warrant officer, the first sergeant, the master sergeant, the technical sergeant, all staff sergeants, the bugler, the messengers, and the orderlies carried carbines. All others had rifles.

**Additional Duties:** One T-4 cook runs the regimental officers' mess. The bugler and the two orderlies drive three of the company headquarters jeeps. The auto mechanic also operates the 3/4-ton truck. The communication platoon commander designates personnel who will operate the platoon's jeeps as an additional duty.

**Communication Equipment:** The communication platoon has six SCR-284 long-range radio (probably in the ground version but carried by jeeps), two M-94 encryption devices, and eight SCR-300 man-pack radios. The I&R platoon has four SCR-300 (including one per squad) and three signal lamps. The communication platoon also had 12 EE-8 telephones, 8 CE-11 reel equipments, two BD-72 switchboards and four TG-5 telegraph sets.

**Enlisted Ranks:** See the comments under Appendix 5.1. Interestingly enough there were no rank changes among the non-commissioned officers in the regimental headquarters company on 26 February 1944. However among the private men the number of technicians increased from 29 to 35 (the additional technicians were previously unrated radio operators) though the number of PFC actually declined from 22 to 19.

**Source:** War Department Table of Organization 7-12 "Headquarters and Headquarters Company, Infantry Regiment" (Washington DC 15 July 1943 and 26 February 1944 plus changes dated 30 June 1944)

## Appendix 5.16

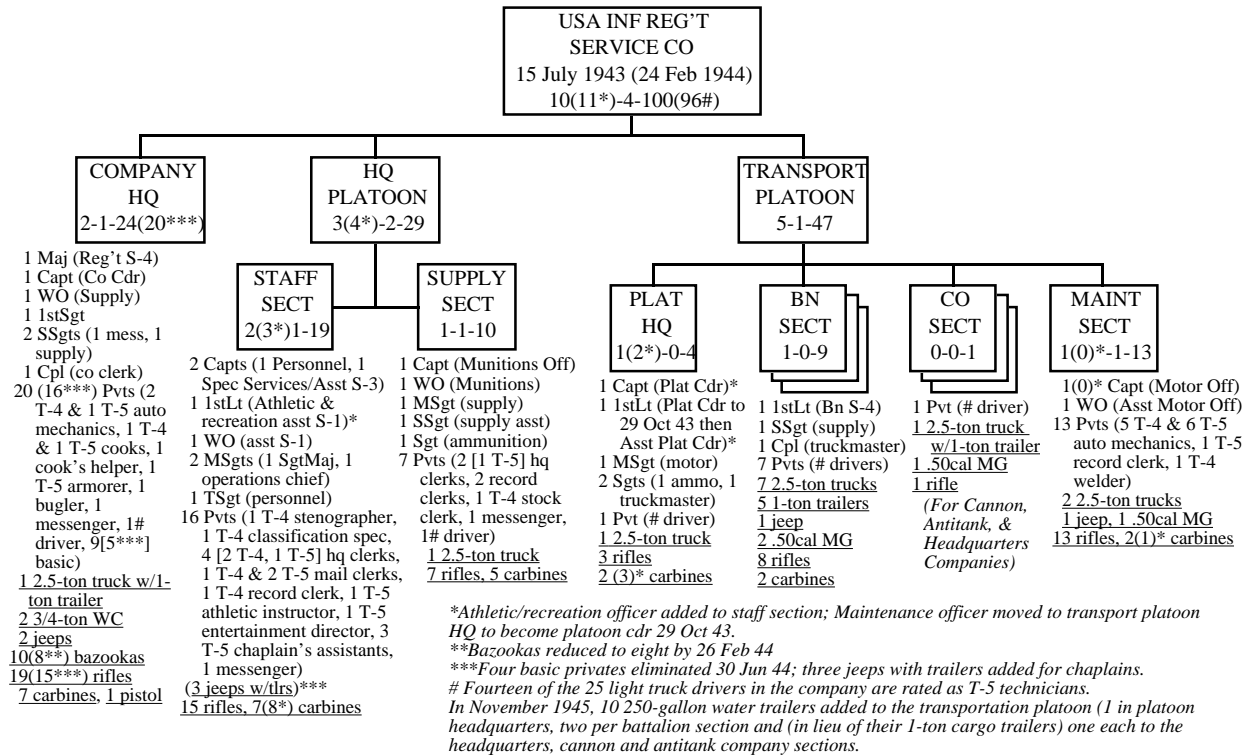

**Notes:**

**Small Arms:** The major carried the only pistol. The other officers, warrant officers, first sergeant, master sergeants, the technical sergeant, all staff sergeants, the bugler and the messengers all carried carbines. All others carried rifles.

**Additional Duties:** The corporal truck-masters in the battalion sections and the bugler and the messenger in company headquarters also drove jeeps. Two auto mechanics (one T-4 and one T-5) in company headquarters also drove 3/4-ton weapons carrier (WC) trucks. The three jeeps that the War Department added to the staff section of the headquarters platoon were for the use of the three regimental chaplains and were driven by the chaplain's assistants.

**Communication Equipment:** The service company had only two flag sects and 16 panel sets. It had no radio or telephone equipment at all, though it could probably obtain this equipment as needed from the regimental communication platoon.

**Enlisted Ranks:** See the comments under Appendix 5.1. As in the regimental headquarters company the reorganization of 26 February did not affect the ranks of service company non-commissioned officers. It did not affect the private men either. The number of technicians remained at 49 and there were only 12 PFC.

**Source:** War Department Table of Organization 7-13 "Service Company, Infantry Regiment" (Washington DC 15 July 1943 and 26 February 1944 plus changes dated 30 June 1944)

Appendix 5.17

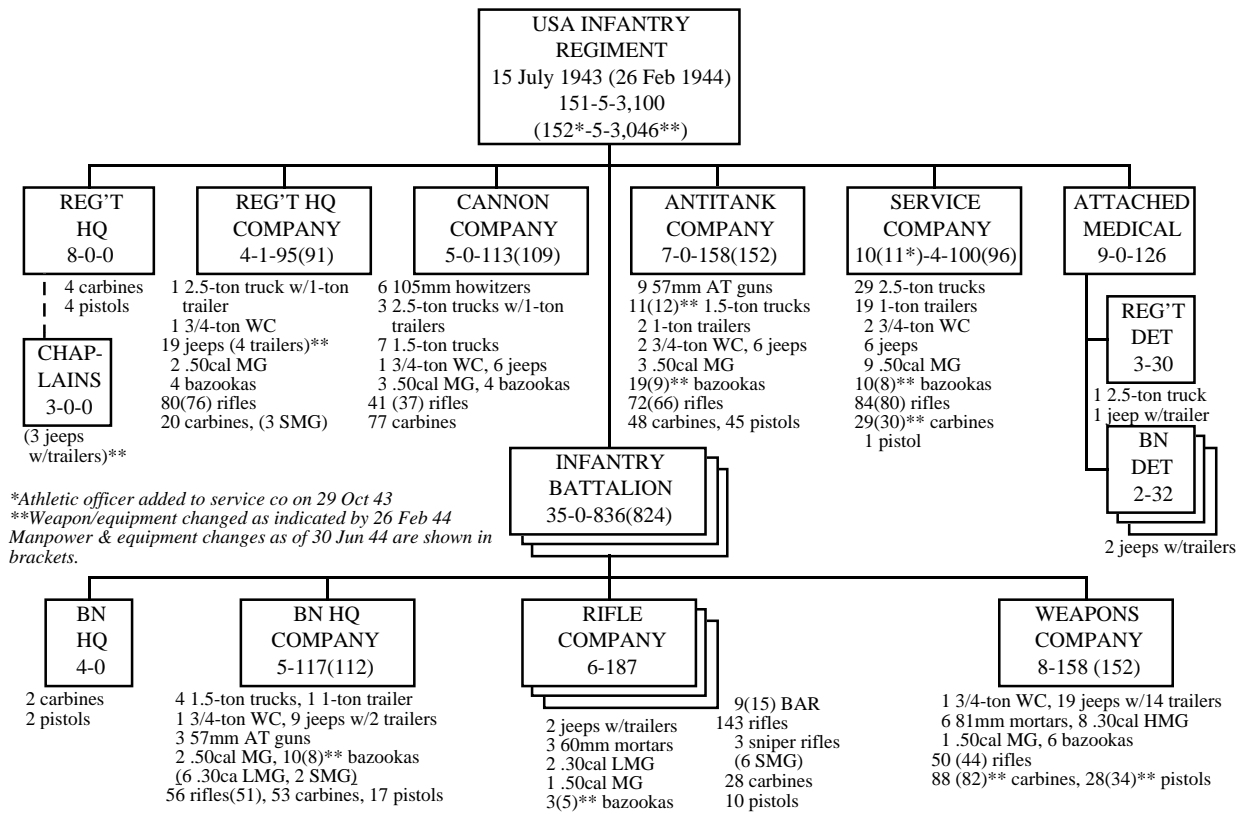

\*Athletic officer added to service co on 29 Oct 43  
 \*\*Weapon/equipment changed as indicated by 26 Feb 44  
 Manpower & equipment changes as of 30 Jun 44 are shown in brackets.

Notes:

Attached Medical:

**Regimental Detachment:** Had one major (regimental surgeon), two captains or first lieutenants (both dental), a technical sergeant (medical), a sergeant (medical), 10 surgical technicians (including three company medics for the cannon company and three for the antitank company), one podiatrist (T-4), one medical technician, two dental technicians (T-5), one sanitary technician, one record clerk (T-5) who also drove a jeep, one truck driver, and 11 basic privates.

**Each Battalion Detachment:** Had two captains or first lieutenant, one staff sergeant (medical), one corporal (medical), 14 surgical technicians (including three company medics for each rifle or weapons company), four medical technicians (of whom two also drive the section jeeps) and 12 litter bearers (three squads of four).

Out of 52 surgical technicians in the medical detachment, nine ranked as T-3 (staff sergeant equivalent) technicians, nine were T-4 (sergeant equivalent) and 17 were T-5 (corporal equivalent). Out 13 medical technicians two ranked as T-4 and three as T-5.

The reorganization of 26 February 1944 did not affect the infantry regimental medical detachment.

Source: War Department Table of Organization 7-11 "Infantry Regiment" (Washington DC 15 July 1943 and 26 February 1944 plus changes dated 30 June 1944).

## Appendix ?

### Comparative Table of Enlisted Ranks for the US Army and Marine Corps (1941-45)

The Army and Marine Corps took very different approaches to their enlisted rank structures up until the emergence of the Department of Defense in 1947. Congress limited both services to seven enlisted pay grades from about 1923. Both services were concerned not only with ensuring that men with appropriate seniority and demonstrated leadership ability be promoted. However they also wanted those who had acquired valuable technical skills be retained and rewarded through increases in pay and prestige but not necessarily in leadership responsibility.

The Army's approach was very straightforward. It offered seven leadership ranks with appropriate titles and five technical ranks that were numbered only. Technicians wore non-commissioned officer stripes corresponding to their pay grade but they also wore a large "T" underneath (or between their "stripes" and "rockers") to distinguish them from actual non-commissioned officers with command authority.

US Army		
Pay Grade	Leadership	Technical
1	Master Sergeant	T-1
2	Technical Sergeant	T-2
3	Staff Sergeant	T-3
4	Sergeant	T-5
5	Corporal	T-5
6	Private First Class	
7	Private	

Like the Army the Marine Corps offered a "leadership" path of seven pay grades but early in his career a Marine could take a different path corresponding to his area of technical specialty on which titles and level of authority might be very different. The table below shows some of the primary specialty areas in which a Marine enlisted man might have a career. The basic leadership (non-technical) rank path is on the left. The ordnance field includes small arms and artillery repair and chemical warfare related equipment. The technical field could include communication or automotive maintenance. The mess (food service) and paymaster should be self-explanatory. The quartermaster field covered all aspects of supply and logistics. Not shown is the administrative field. Its rank titles were the same as those in the paymaster field except that the most senior rank could be a first sergeant or a master technical sergeant. The music field was also similar but the men were titled "field music first class" (Grade 2), "field music corporal" (Grade 3), "field music sergeant" (Grade 4), staff sergeant, technical sergeant, and master technical sergeant.

US Marine Corps						
Grade	Leadership	Ordnance	Technical	Mess	Paymaster	Quartermaster
1	Sergeant Major or First Sergeant	Master Gunnery Sergeant	Master Technical Sergeant	Master Technical Sergeant (Mess)	Paymaster Sergeant	Quartermaster Sergeant
2	Gunnery Sgt.	Gunnery Sgt.	Technical Sgt.	Technical Sgt.	Technical Sgt.	Supply Sergeant
3	Platoon Sergeant	Staff Sergeant	Staff Sergeant	Chief Cook	Staff Sergeant	Staff Sergeant
4	Sergeant	Sergeant	Sergeant	Field Cook	Sergeant	Sergeant
5	Corporal	Corporal	Corporal	Assistant Cook	Corporal	Corporal
6	Private First Class	Private First Class	Private First Class		Private First Class	Private First Class
7	Private					

Hopefully, this discussion will enable readers to make more sense out of the rank designations given in the diagrams.

Appendix 5.18

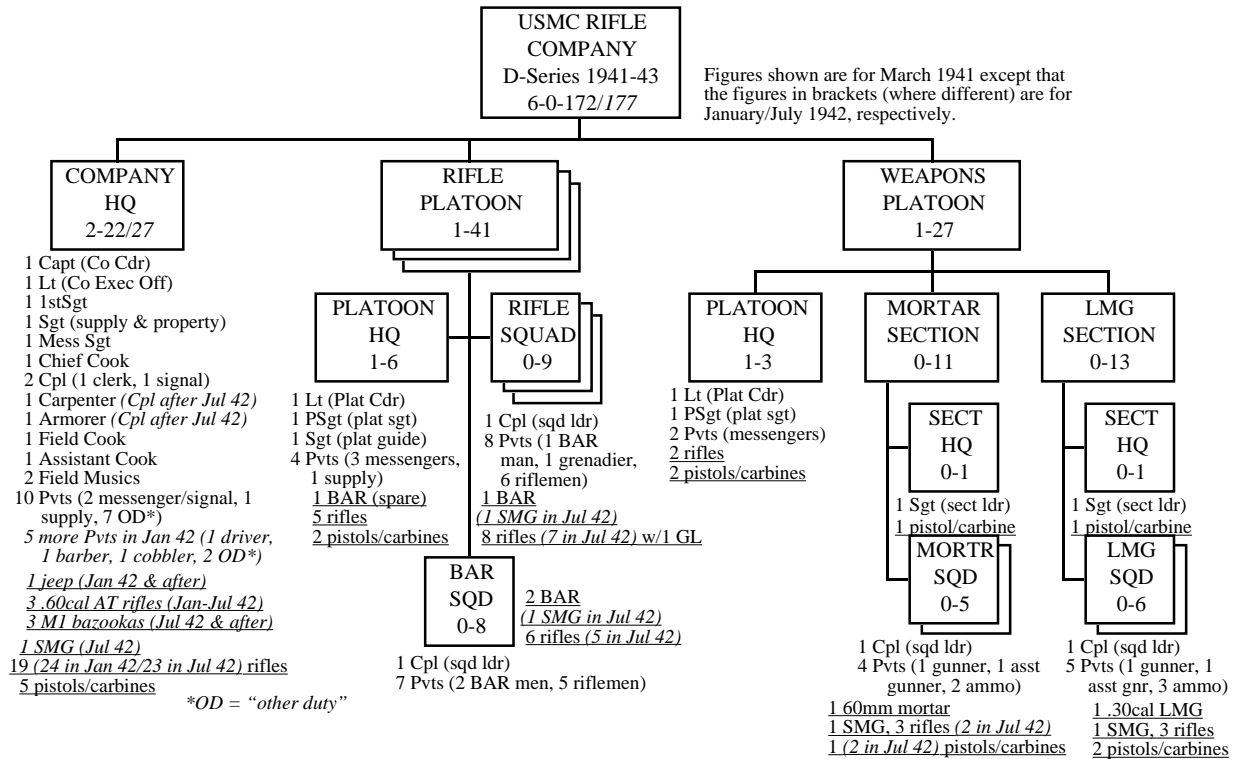

Notes:

**Small Arms:** No carbines or M1 rifles were available for Marine Corps units until mid-1943. Until then M1903 rifles replaced M1 rifles and pistols replaced carbines. In March 1941 and January 1942 the only sub-machineguns authorized for a rifle company were for LMG and 60mm mortar squad leaders. These were to have been Thompson guns. With the apparent availability of Reising guns in July 1942 rifle and BAR squad leaders and the company driver were to have exchanged their rifles for sub-machineguns though it is difficult to say to what extent this occurred. Some may have received Thompsons rather than Reising. In general, pistols or carbines were issued to all officers, field musics and other enlisted men ranking above sergeant. They were also issued to mortar and LMG gunners and to LMG assistant gunners. Assistant 60mm mortar gunners were to carry pistols in lieu of rifles beginning in July 1942. One man per rifle squad would have carried a grenade launcher on his rifle.

**Other Weapons:** No bazookas were available until late 1943. A .60-cal antitank rifle was planned as a substitute but never issued.

**Rifle Squads:** Until July 1942 the Marine Corps had hoped to expand its rifle squads to a sergeant, a corporal and 11 privates each. BAR squads would have remained the same but platoon headquarters would lose its platoon guide. A rifle platoon would have had an officer and 52 men (a platoon sergeant, three sergeants, four corporals and 44 privates). Each rifle or BAR squad leader would have carried a Thompson sub-machinegun. The number of BAR's would have remained the same.

**Source:** Marine Corps Table of Organization D-1 "Rifle Company, Infantry Battalion, Infantry Regiment" (HQMC Washington DC versions dated 28 March 1941, 28 March 41/10 January 1942, and 1 July 1942).

## Appendix 5.19

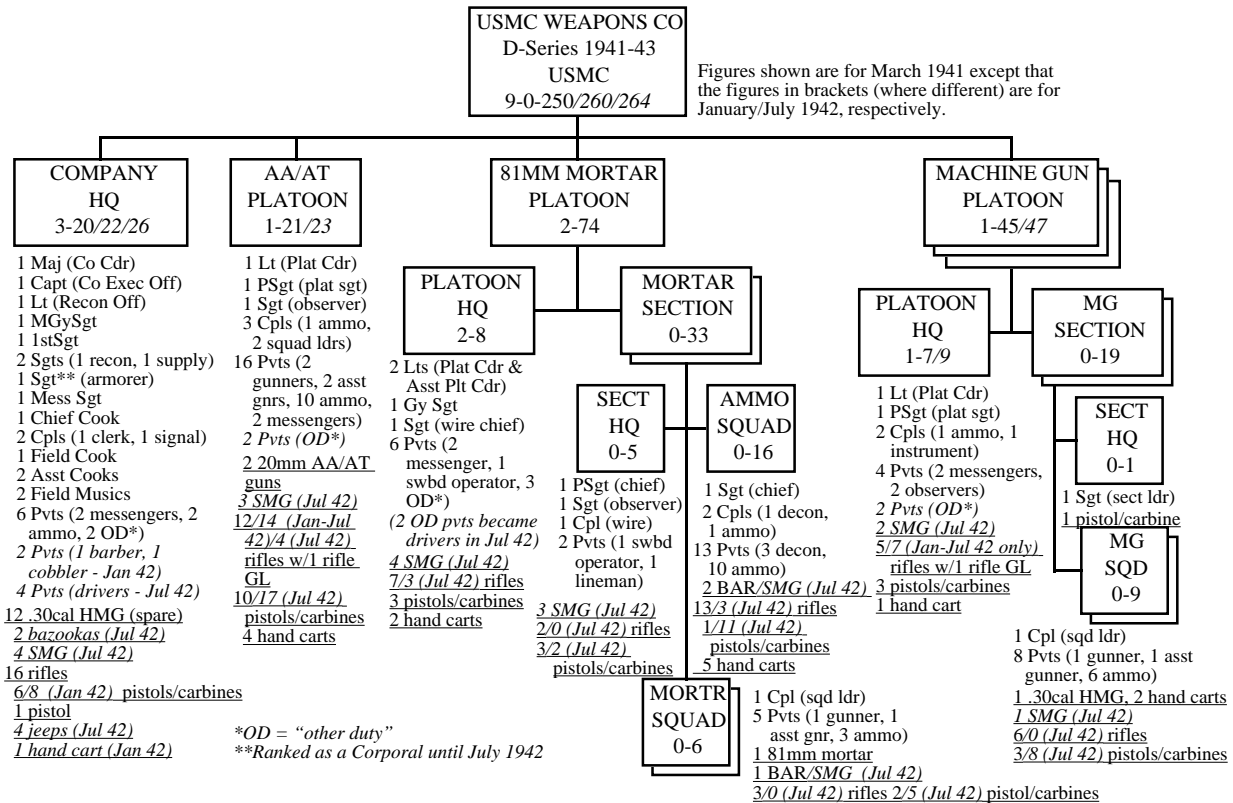

**Notes:**

**Small Arms:** No carbines or M1 rifles were available until early to mid-1943 so pistols and M1903 rifles, respectively, were substituted until then. The major (company commander) as a field grade officer would carry a pistol. In January 1942 all company headquarters personnel carried rifles except for the officers, first sergeant, master gunnery sergeant and field musics who were to carry pistols or carbines. In the AA/AT, mortar and machinegun platoons all platoon sergeants (and higher), all section leaders, observers, gunners, assistant gunners and linemen carried pistols or carbines as did machinegun and AA/AT squad leaders, the ammunition sergeants in the mortar platoon, the ammunition corporal in the AA/AT platoon and the decontamination corporals in the machinegun platoons. In the mortar platoon the ammunition and decontamination corporals and the four mortar squad leaders carried BAR's. With the large-scale introduction of sub-machineguns in July 1942, sub-machineguns were to go to all the drivers in the company, the switchboard operators and telephone linemen in the mortar platoon and all the corporals in the company except for the two in company headquarters. In addition all the ammunition and supply (ammo) men in the company (excluding corporals) were to exchange their rifles for pistols or carbines. Finally, the "other duty" privates in the machinegun and AA/AT platoons were to carry grenade launchers on their rifles. How much of this was actually implemented is anyone's guess but it is likely that many if not all the ammunition men retained their rifles and in many cases the mortar squad and ammunition corporals retained their BAR's. At least some sub-machineguns probably were issued. Machinegun platoon and communication personnel probably had priority for them.

**Other Weapons:** No bazookas were available until late 1943 and no substitute weapons were available either. The dual purpose 20mm antiaircraft and antitank guns never arrived and in battalion weapons companies .50-caliber machineguns were substituted.

**Source:** Marine Corps Tables of Organization D-2 "81mm Mortar Platoon Weapons Company, Infantry Battalion, Marine Division," D-3 "Weapons Company, Infantry Battalion, Infantry Regiment" (HQMC Washington DC versions dated 28 March 1941, 28 March 41/10 January 1942, and 1 July 1942).

## Appendix 5.20

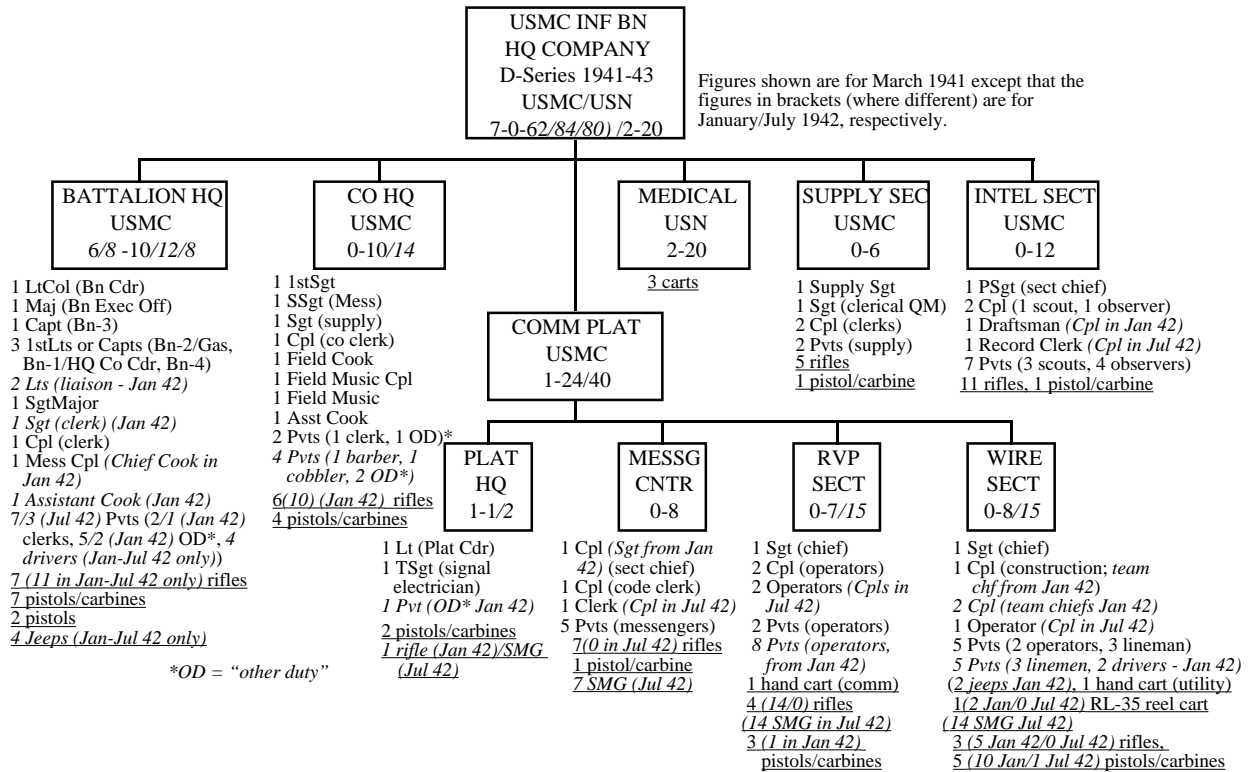

**Notes:**

**Small Arms:** Prior to July 1942 Marines ranking as sergeants or below (except field musics) would carry rifles while the officers and the more senior enlisted Marines were to carry pistols or carbines. However the lieutenant colonel and major were to carry pistols even when carbines were available. In July 1942 members of the communication platoon who had previously carried rifles were to exchange them for sub-machineguns. It appears that many, if not all, actually did.

**Officer's Mess:** The field cook (mess corporal until January 1942) and assistant cook (added in January 1942) in the battalion headquarters section were for a battalion officer's mess.

**Source:** Marine Corps Table of Organization D-4 "Headquarters Company, Infantry Battalion, Infantry Regiment" (HQMC Washington DC versions dated 28 March 1941, 28 March 41/10 January 1942, and 1 July 1942).



## Appendix 5.21

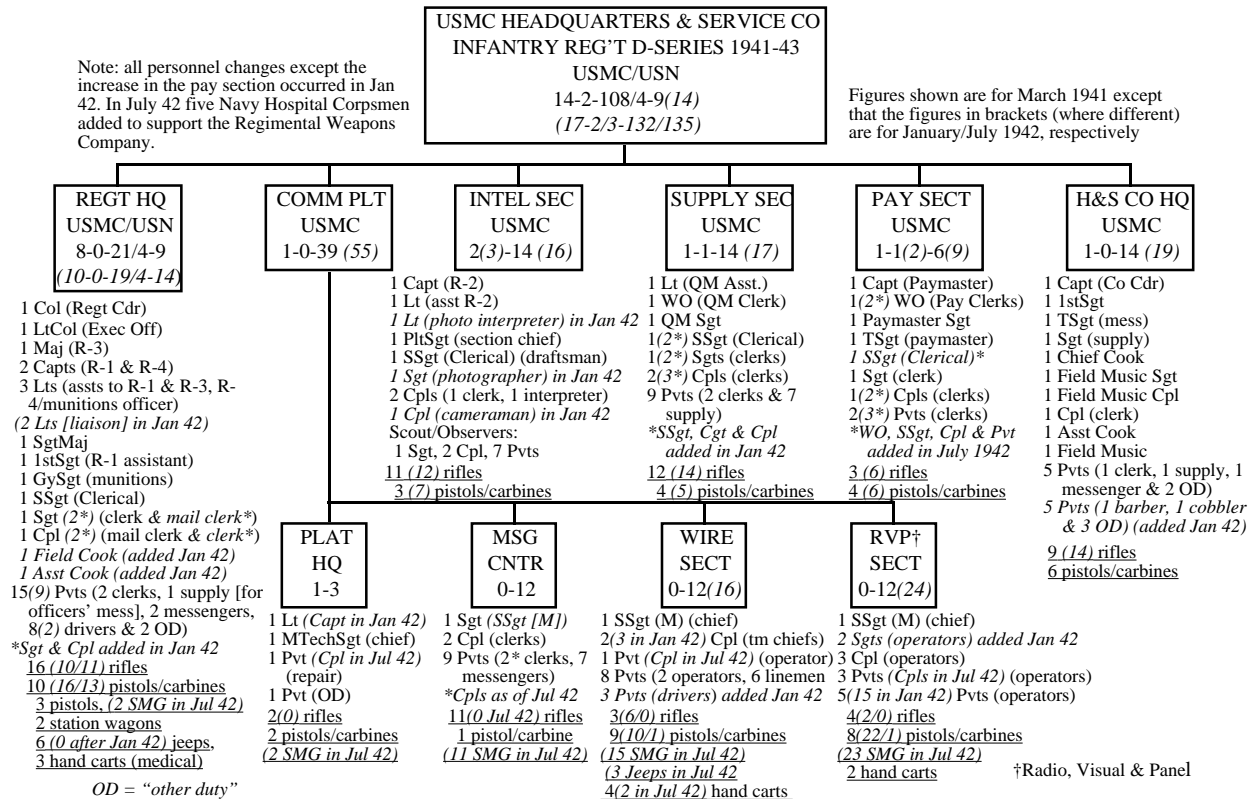

**Notes:**

**Small Arms:** Field grade officers (colonels, lieutenant colonels and majors) carried pistols only. Company grade officers (captains and lieutenants), warrant officers, enlisted men ranking higher than sergeant, and field musics were to carry pistols or carbines. Also pistol or carbine-armed were the mail clerk and two drivers in the regimental headquarters and everyone in the wire section of the communication platoon except three switchboard operators and (after January 1942) three drivers. In the RVP section everyone was to carry pistols or carbines except four privates but after January 1942 the number of privates increased to eighteen, all armed with pistols or carbines. Two sergeants, added to the section at the same time carried the only rifles. From July 1942 everyone in the communication platoon except staff sergeants and higher would carry a sub-machinegun. Sub-machineguns would also go to the sergeant and corporal mail clerks in regimental headquarters.

**Officer's Mess:** A field cook and an assistant cook were added to the regimental headquarters section in January 1942 in order to establish a regimental officer's mess.

**Source:** Marine Corps Table of Organization D-9 "Headquarters and Service Company, Infantry Regiment" (HQMC Washington DC versions dated 28 March 1941, 28 March 41/10 January 1942, and 1 July 1942).

## Appendix 5.22

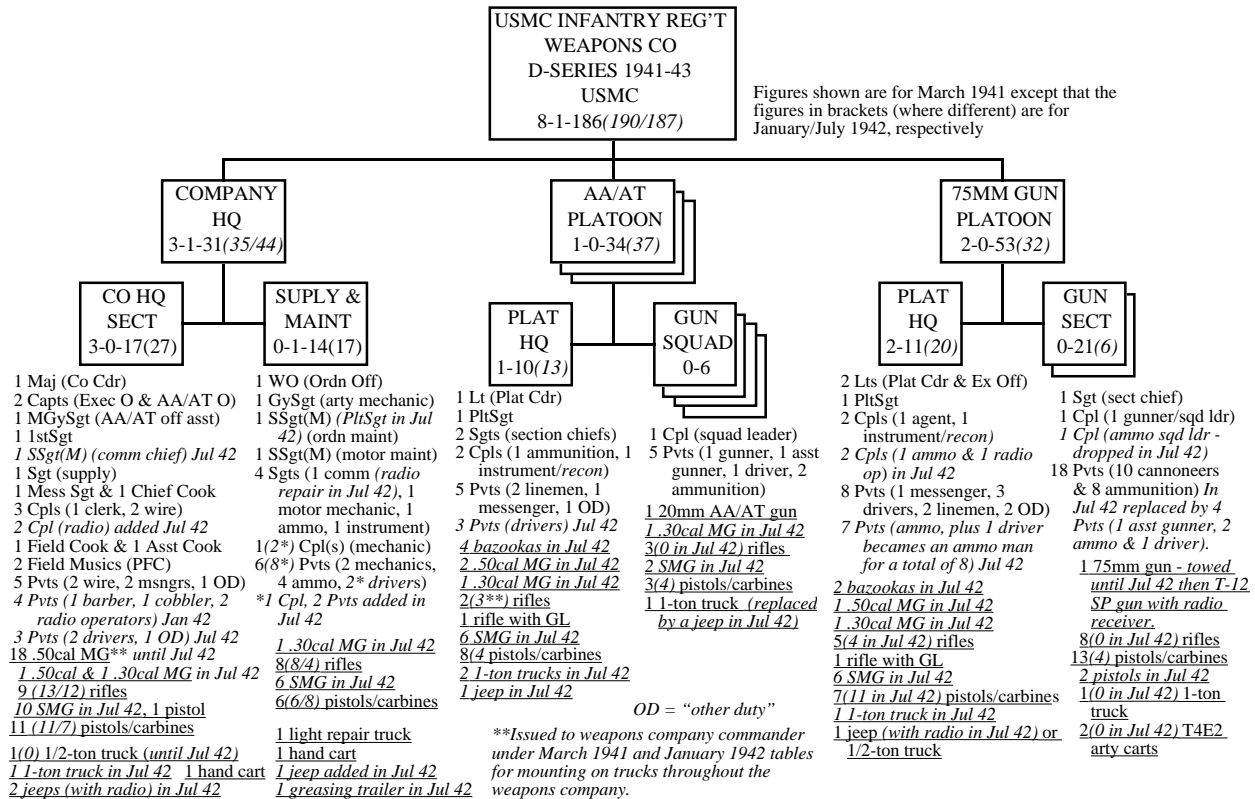

**Notes:**

**Small Arms:** All ranks above sergeant were to carry pistols or carbines. The major (company commander) carried a pistol only. The section leaders, squad leaders, ammunition, communication (or wire or agent) and instrument sergeants and corporals, gunners, assistant gunners, field musics, linemen (wire-men), and the ammunition bearers and two cannoneers per gun in the 75mm gun platoon were to also carry pistols or carbines. All others were to carry rifles. After July 1942 sub-machineguns were supposed to go to the four sergeants in the supply and maintenance section and to corporals and privates who were AA/AT squad leaders, ammunition NCO's, radio operators, wire-men, or drivers. All "other duty" privates except for the two in company headquarters would carry rifles with grenade launchers.

**Other Weapons:** The 20mm AA/AT guns that were supposed to arm the AA/AT platoons never arrived so M3 37mm towed antitank guns were issued instead. The self-propelled 75mm guns were not delivered either so regiments used the towed 75mm guns until the end of 1942. The bazookas never became available until the end of 1943 but there was no substitute available to issue in their place. Since no carbines were available until early 1943 pistols were substituted until then. Until July 1942 the company maintained 18 .50-caliber machineguns for mounting on motor vehicles throughout the regiment as air defense weapons. These guns proved to be too heavy for the lighter vehicles in the regiment so in July 1942 18 .30-caliber LMG replaced ten of the .50-caliber guns. Thereafter each of the one-ton trucks in the weapons company (except the light repair truck) would mount a .50-caliber machinegun and each jeep (except for one radio vehicle in company headquarters) would mount a .30-caliber machinegun. All these were heavily loaded to begin with (especially the trucks towing the 75mm guns) and the extra weight of these weapons and their ammunition did not make matters any better.

**Source:** Marine Corps Table of Organization D-7 "Weapons Company, Infantry Regiment" (HQMC Washington DC versions dated 28 March 1941, 28 March 41/10 January 1942, and 1 July 1942).

### Appendix 5.23

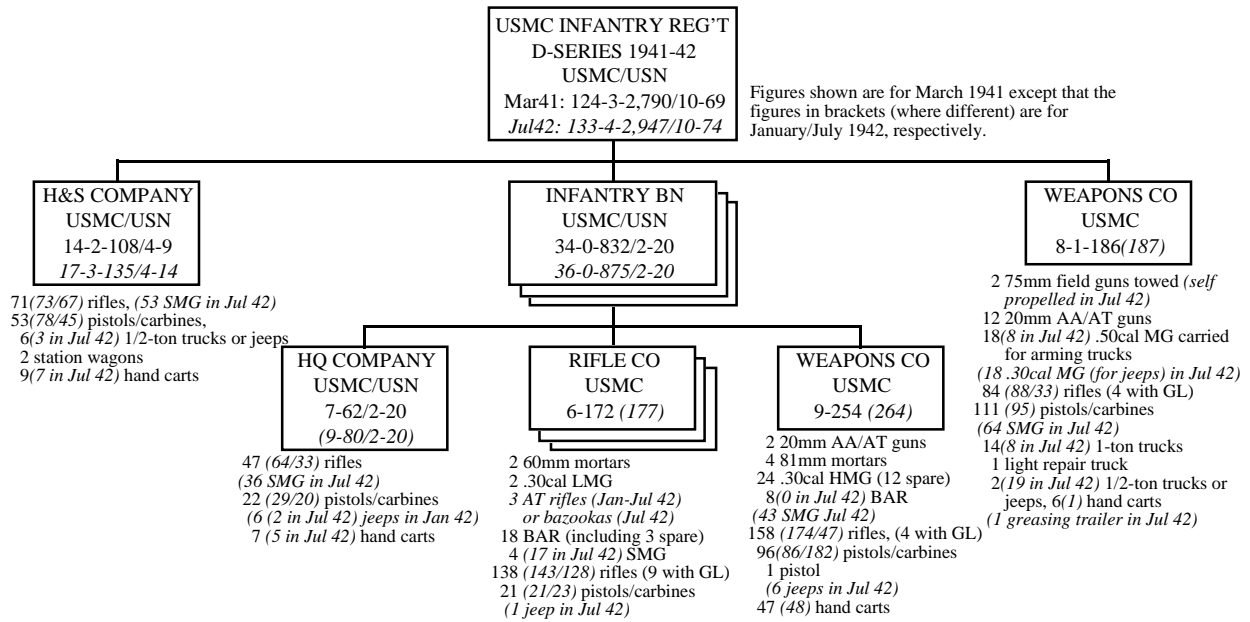

**Notes**

Source: Marine Corps Table of Organization D-10 "Infantry Regiment, Marine Division" (HQMC Washington DC versions dated 28 March 1941, 28 March 41/10 January 1942, and 1 July 1942).

Appendix 5.24

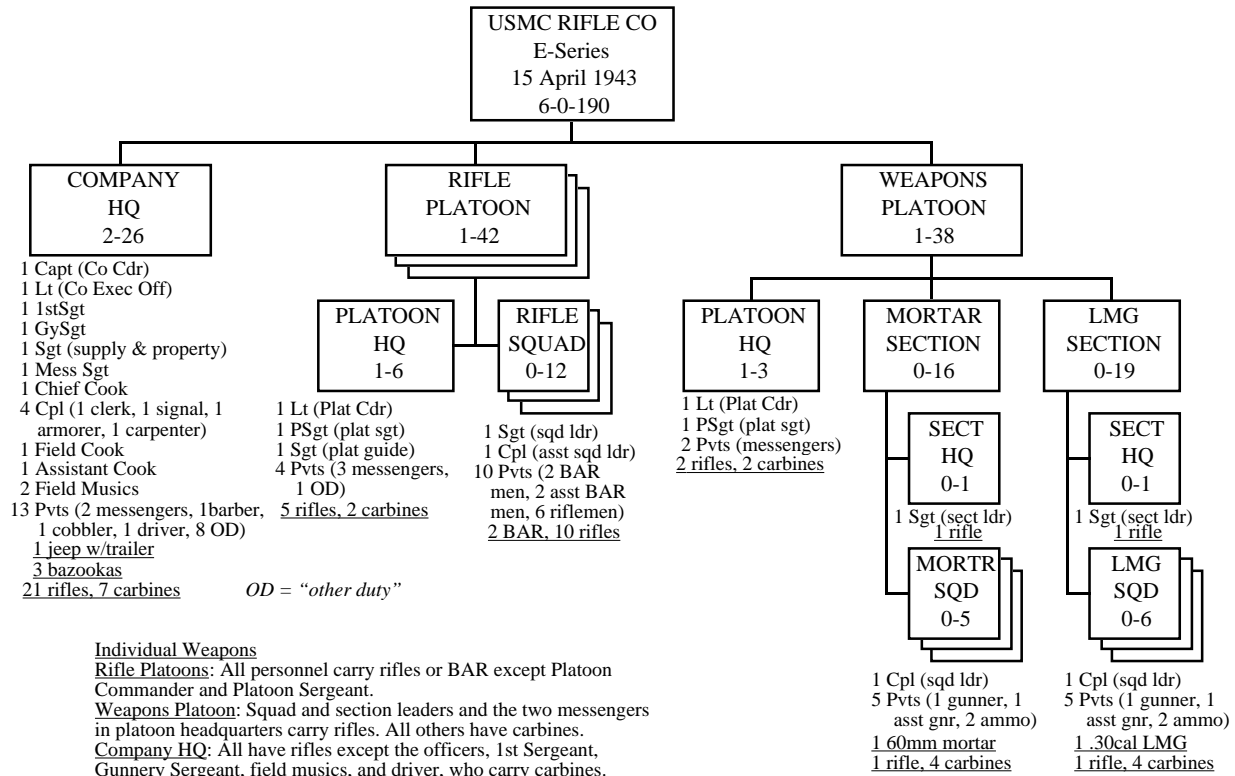

Notes:

Weapons: Bazookas were not available until late 1943. None reached the 2<sup>nd</sup> Marine Division in time for its assault on Tarawa. The 1<sup>st</sup> Marine Division received a few prior to the close of its Cape Gloucester operation.

Source: Marine Corps Table of Organization E-1 "Rifle Company, Infantry Battalion, Infantry Regiment" (HQMC Washington DC dated 15 April 1943).

Appendix 5.25

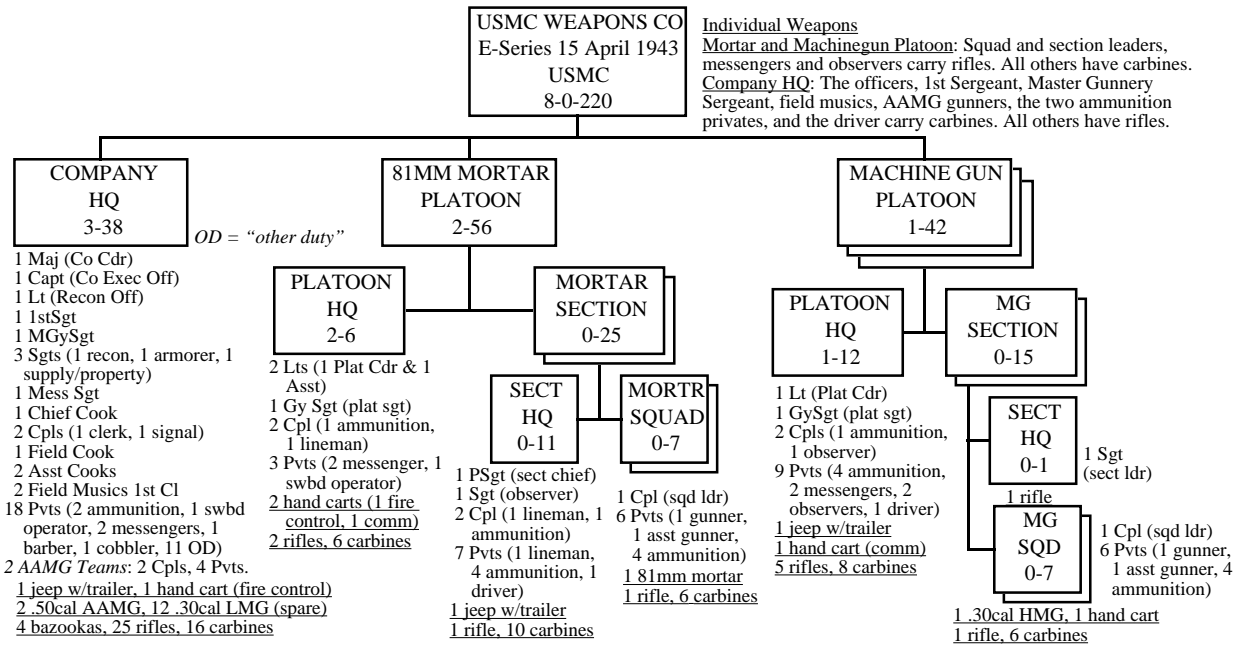

Notes:

Weapons: Bazookas were not available until late 1943. None reached the 2<sup>nd</sup> Marine Division in time for its assault on Tarawa. The 1<sup>st</sup> Marine Division received a few prior to the close of its Cape Gloucester operation.

Source: Marine Corps Table of Organization E-3 "Weapons Company, Infantry Battalion, Infantry Regiment" (HQMC Washington DC dated 15 April 1943).

Appendix 5.26

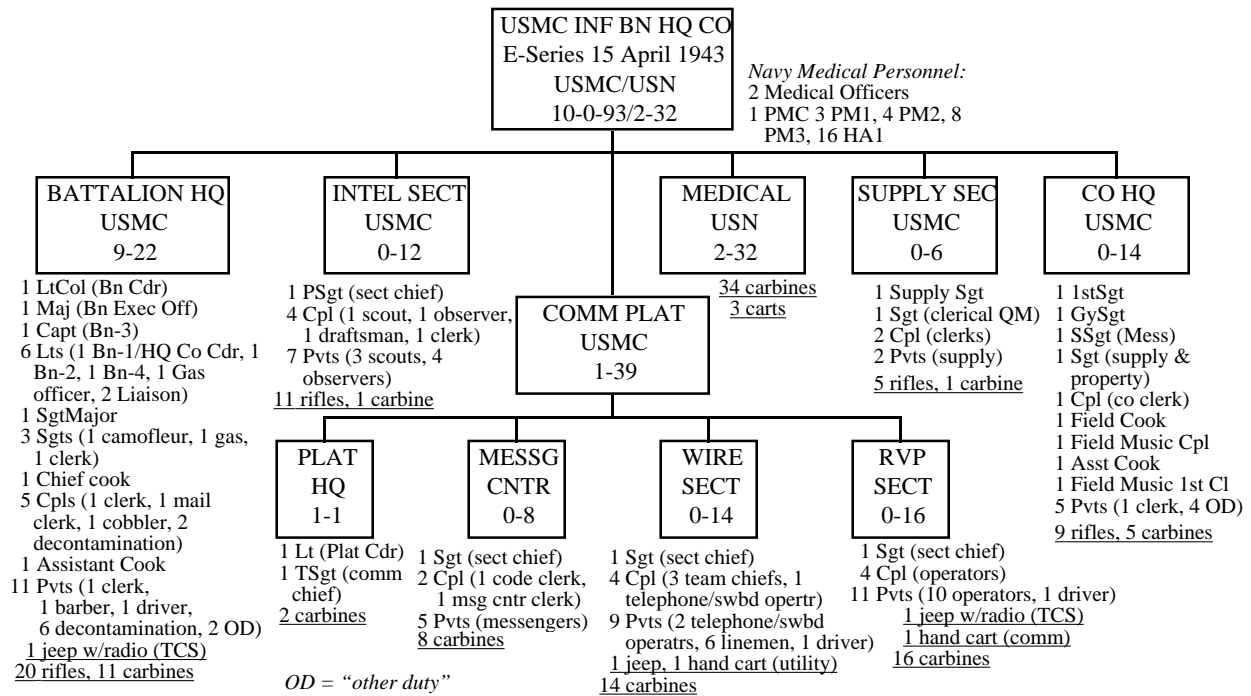

Notes:

**Navy Medical Personnel:** The medical officers were in the medical corps (one of them might be medical service corps instead) and usually ranked as lieutenants or lieutenants junior grade (j.g.). A PMC was a chief pharmacist's mate (of grade 1 or equivalent to a master sergeant in the Army or sergeant major in the Marines). PM1, PM2 or PM3 were, respectively pharmacist mates 1<sup>st</sup>, 2<sup>nd</sup> or 3<sup>rd</sup> class, occupying pay grades 2, 3 or 4 and ranking equivalent to technical or gunnery sergeant, staff sergeant or sergeant, respectively. An HA1 was a hospital apprentice 1<sup>st</sup> class or in pay grade 5, equivalent to a corporal.

**Small Arms:** All officers, all non-commissioned officers ranking above sergeant, field musics, the driver in battalion headquarters and all personnel in the communication platoon carried carbines. Carbines were available for Navy medical personnel also. All others carried rifles.

**Officer's Mess:** The field cook and assistant cook in the battalion headquarters section are for a battalion officer's mess.

**Source:** Marine Corps Table of Organization E-4 "Headquarters Company, Infantry Battalion, Infantry Regiment" (HQMC Washington DC dated 15 April 1943).

Appendix 5.27

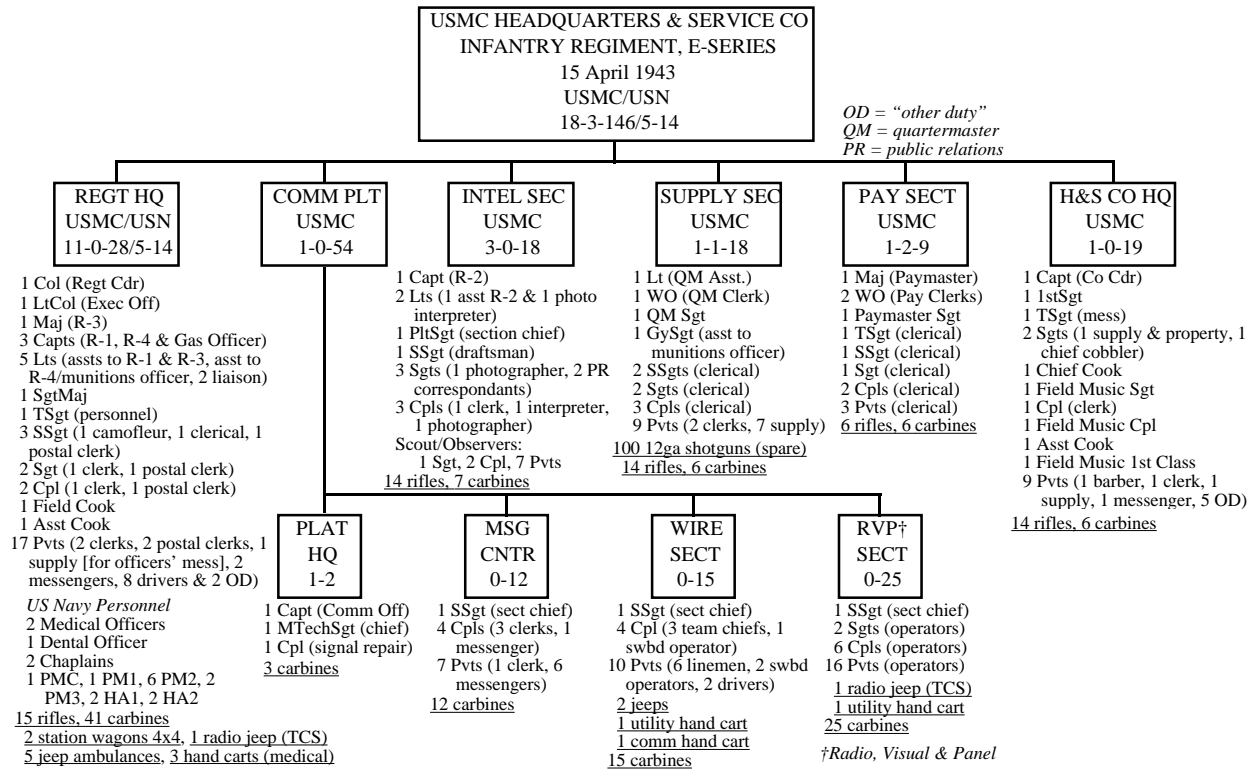

Notes:

**Small Arms:** All officers and warrant officers, all enlisted men ranking above sergeants and field musics, photographers, and all members of the communication platoon carry carbines. Carbines are also maintained for all Navy medical personnel for use as required. All others carry rifles.

**Medical:** Five of the Navy PM2 (Pharmacist's Mate 2<sup>nd</sup> Class) are for attachment to the regimental weapons company.

**Officer's Mess:** The field cook and assistant cook in the regimental headquarters section are for a regimental officer's mess.

**Other:** The regiment could create a shoe and textile repair unit by grouping cobblers from other companies under the sergeant chief cobbler in the headquarters and service company headquarters.

**Source:** Marine Corps Table of Organization E-9 "Headquarters and Service Company, Infantry Regiment" (HQMC Washington DC dated 15 April 1943).

Appendix 5.28

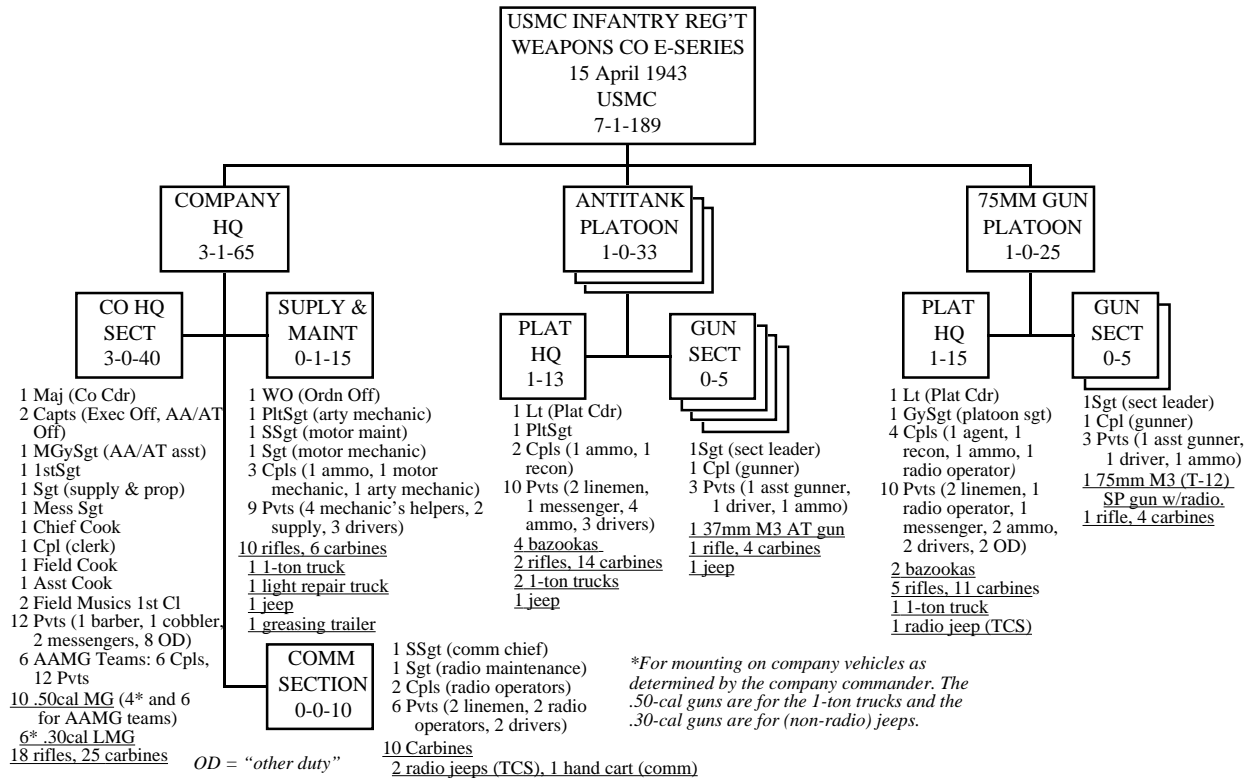

Notes:

**Small Arms:** Officers, the warrant officer, non-commissioned officers ranking above sergeant, drivers, ammunition personnel, all communication personnel (radio and wire), AA machinegunners, antitank and 75mm gunners and assistant gunners carried carbines. All others carried rifles.

**Other Weapons:** No bazookas reached Marine combat units until the end of 1943.

**Source:** Marine Corps Table of Organization E-7 "Weapons Company, Infantry Regiment" (HQMC Washington DC dated 15 April 1943).



Appendix 5.29

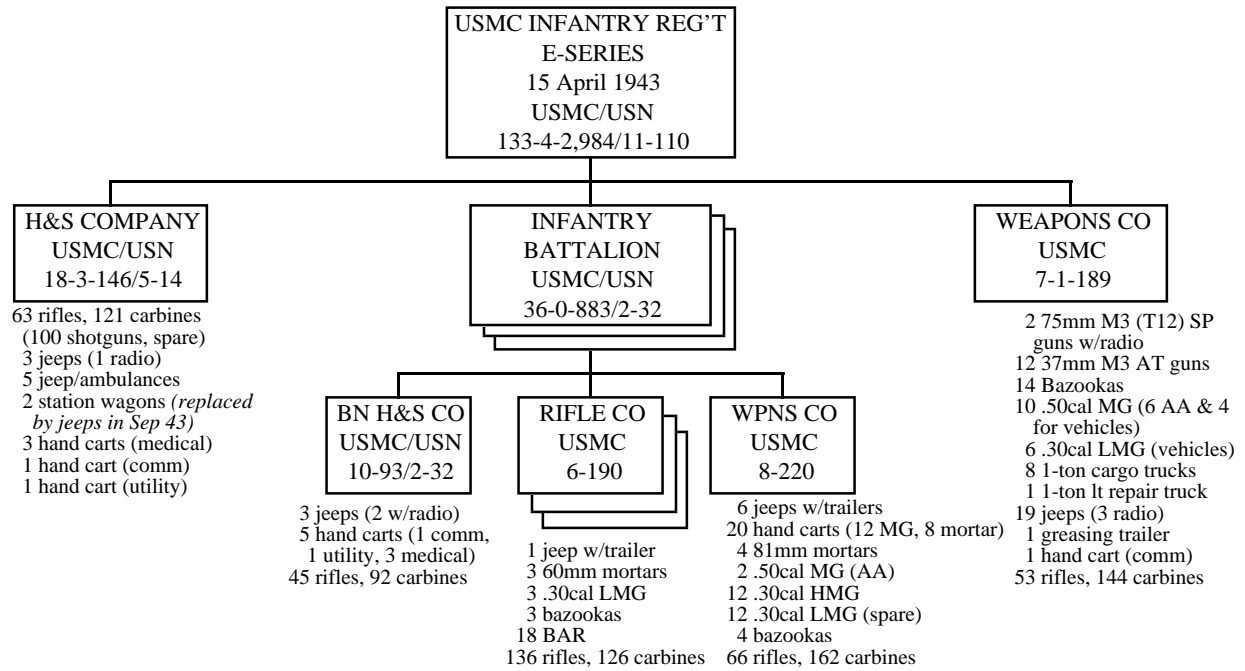

Notes:

Source: Marine Corps Table of Organization E-10 "Infantry Regiment, Marine Division" (HQMC Washington DC dated 15 April 1943).

Appendix 5.30

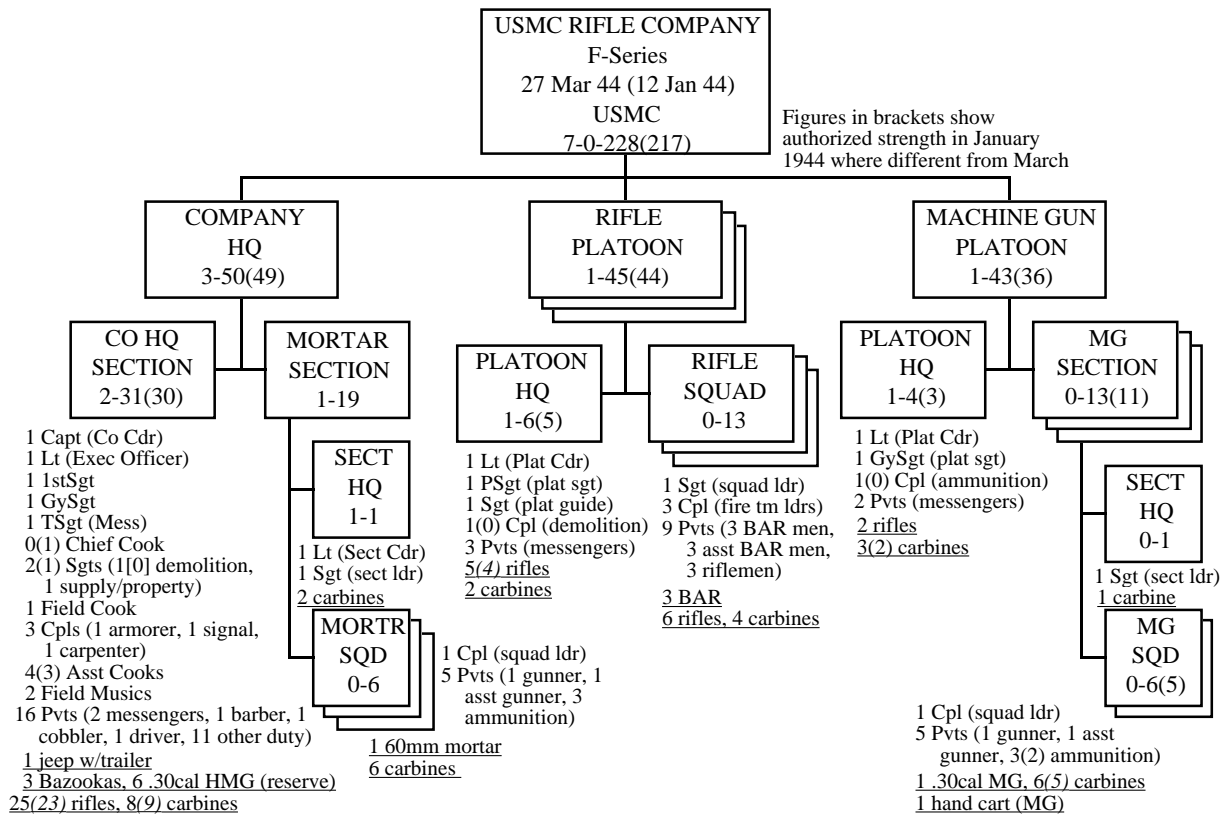

Notes:

**Small Arms:** In the company headquarters, the officers, first sergeant, gunnery sergeant, technical sergeant (mess), chief cook (January to March 1944 only), field musics and the driver carried carbines and all others carried rifles. All mortar section and all machinegun platoon personnel (except two messengers) carried carbines also. In each rifle platoon, carbines went to the platoon commander, platoon sergeant, squad leaders and assistant automatic riflemen.

**Source:** Marine Corps Table of Organization F-1 "Rifle Company, Infantry Battalion, Infantry Regiment" (HQMC Washington DC dated 12 January and 27 March 1944).

### Appendix 5.31

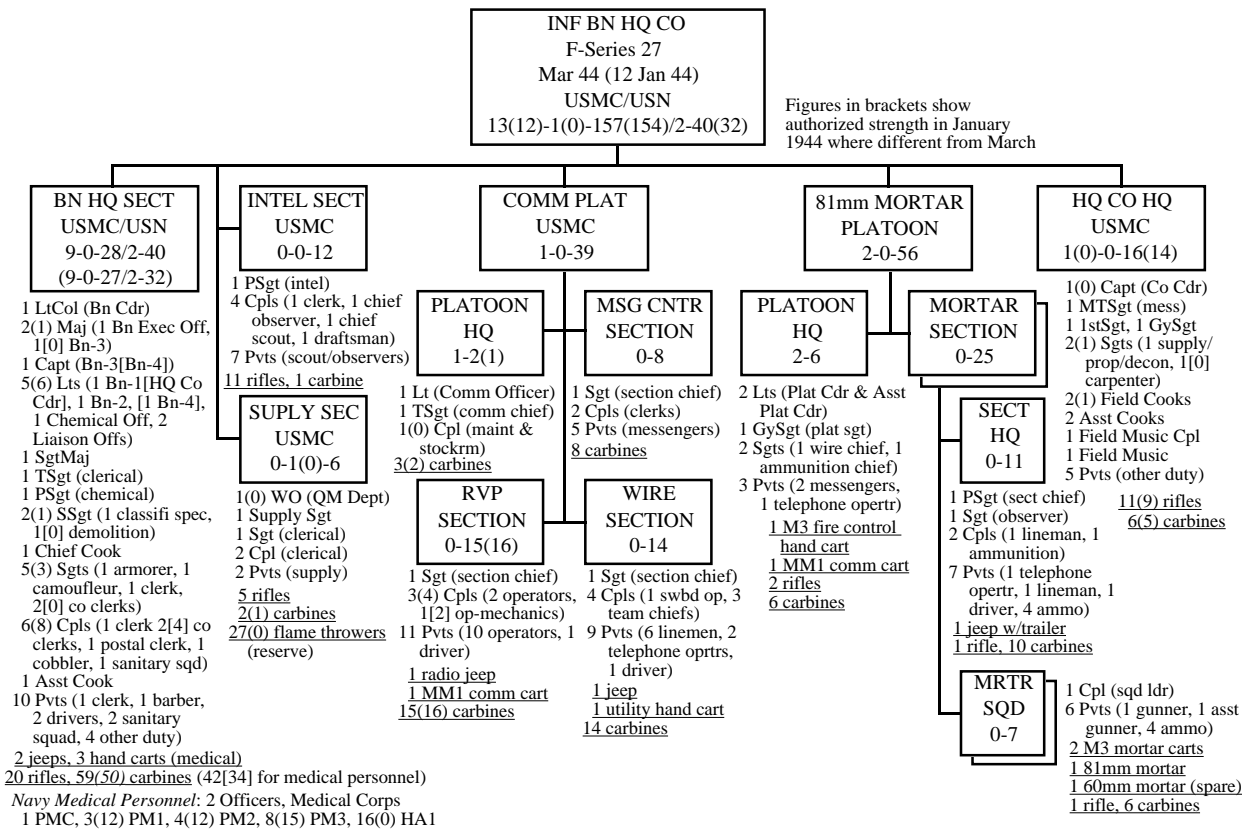

**Notes:**

**Small Arms:** Outside of the communication and mortar platoons, officers, warrant officers, non-commissioned officers ranking above sergeant (including chief cooks), field musics, drivers carry carbines. All others have rifles. All communication personnel have carbines. Mortar platoon personnel carry carbines also except messengers, the mortar section observers (sergeants) and the mortar squad leaders (corporals) who carry rifles. Carbines are also maintained for all Navy medical personnel.

**Mortar Platoon:** Carried 60mm mortars for use as alternative weapons to the 81mm.

**Administration:** The F-Series tables centralized personnel administration within the battalion. All the company clerks moved to the battalion headquarters section where they worked under a technical sergeant (clerical).

**Officer's Mess:** The field cook and assistant cook in the battalion headquarters section were for a battalion officer's mess.

**Source:** Marine Corps Table of Organization F-4 "Headquarters Company, Infantry Battalion, Infantry Regiment" (HQMC Washington DC dated 12 January and 27 March 1944).

Appendix 5.32

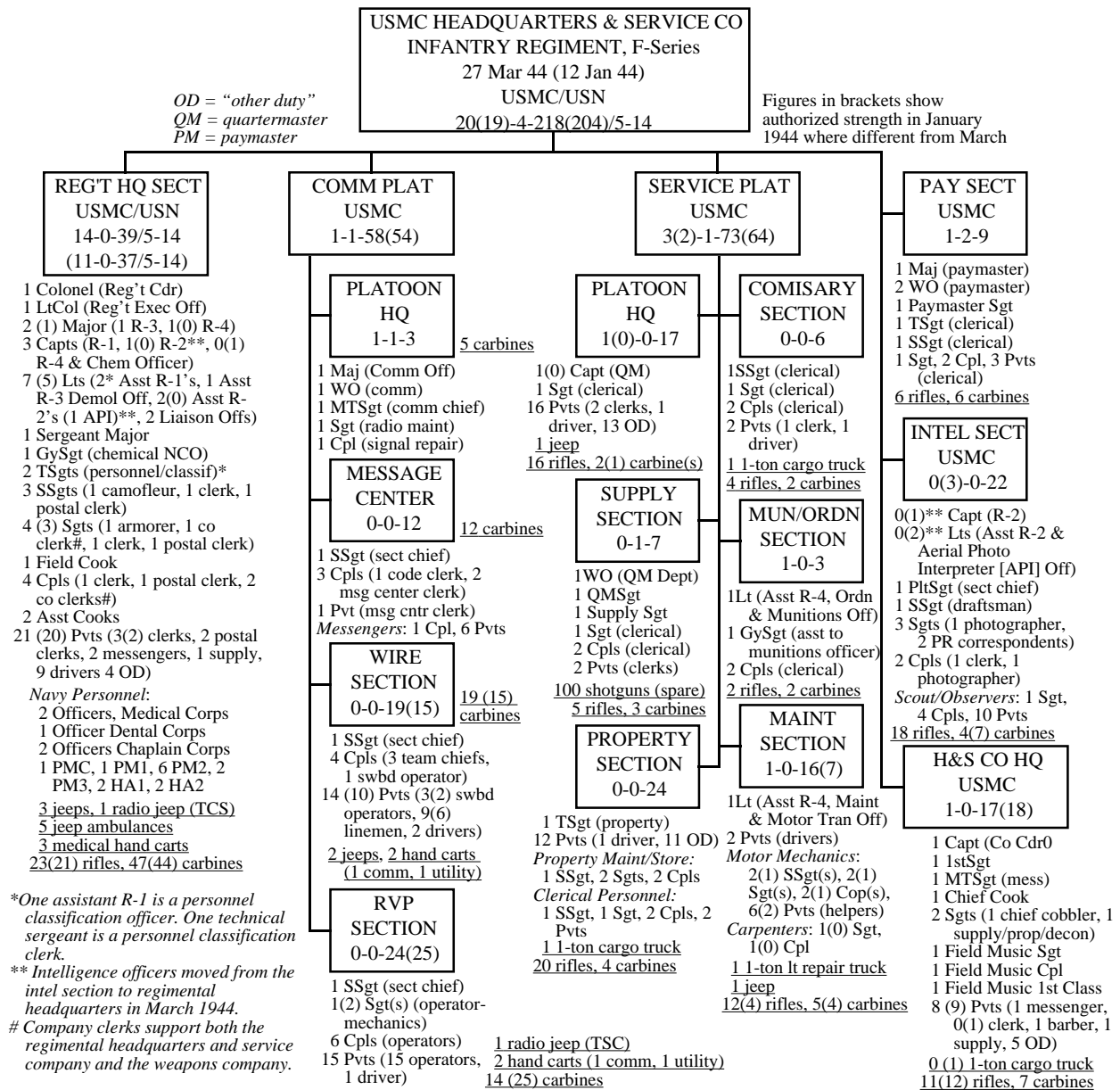

Notes:

**Small Arms:** Officers, warrant officers, non-commissioned officers ranking above sergeant (including the chief cook), field musics, drivers, photographers, and all communication platoon personnel carry carbines. Carbines are also maintained for Navy medical and dental personnel. All others carry rifles.

**Officer's Mess:** The field cook and assistant cooks in the regimental headquarters section were for a regimental officer's mess.

**Medical:** Five Pharmacist's Mates 1<sup>st</sup> Class (PM1) were normally attached to the regimental weapons company.

**Source:** Marine Corps Table of Organization F-9 "Headquarters and Service Company, Infantry Regiment" (HQMC Washington DC dated 12 January and 27 March 1944).

Appendix 5.33

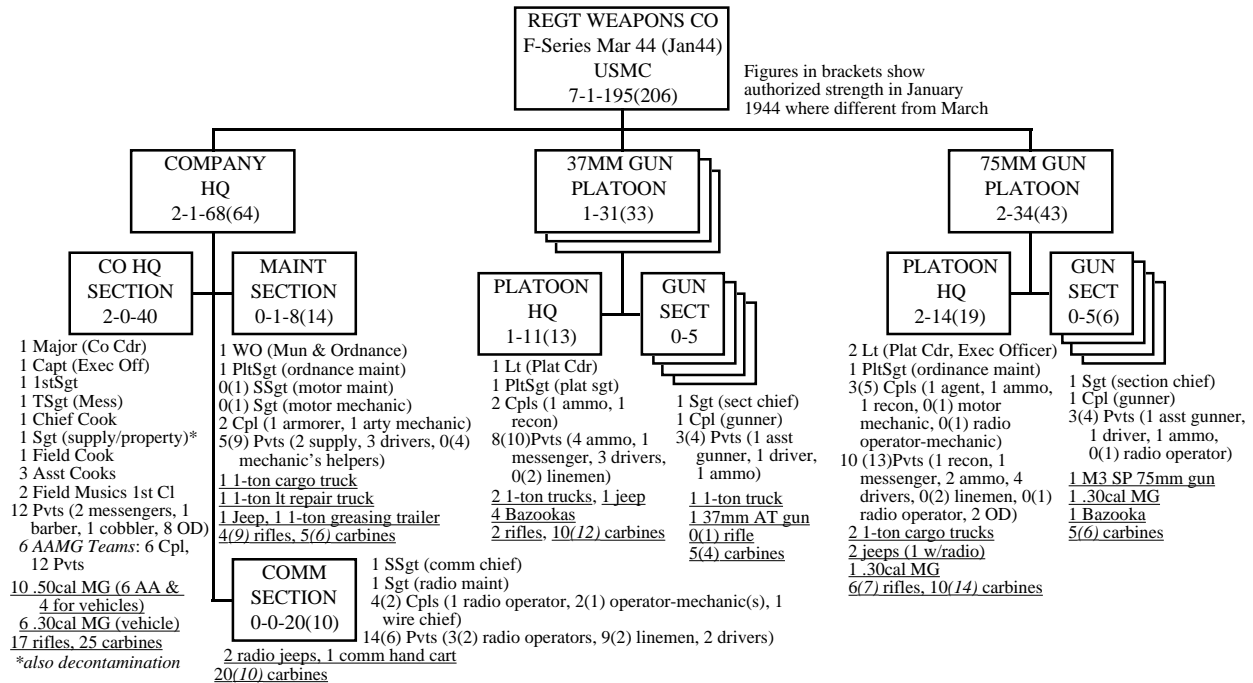

Notes:

**Small Arms:** In the company headquarters the officers, warrant officer, non-commissioned officers ranking above sergeant, all field musics, drivers, and all personnel in the communication section and the anti-aircraft machinegun teams carry carbines. In the 37mm gun platoons, only the reconnaissance corporals and the messengers carried rifles (gun section leaders also carried rifles until March 1944). In the 75mm gun platoon the corporal (agent), corporal (reconnaissance), corporal (motor mechanic – only until March 1944), and four privates (one reconnaissance, one messenger, and two “other duty”) carried the only rifles.

**Source:** Marine Corps Table of Organization F-7 “Weapons Company, Infantry Regiment” (HQMC Washington DC dated 12 January and 27 March 1944).

**Appendix 5.34**

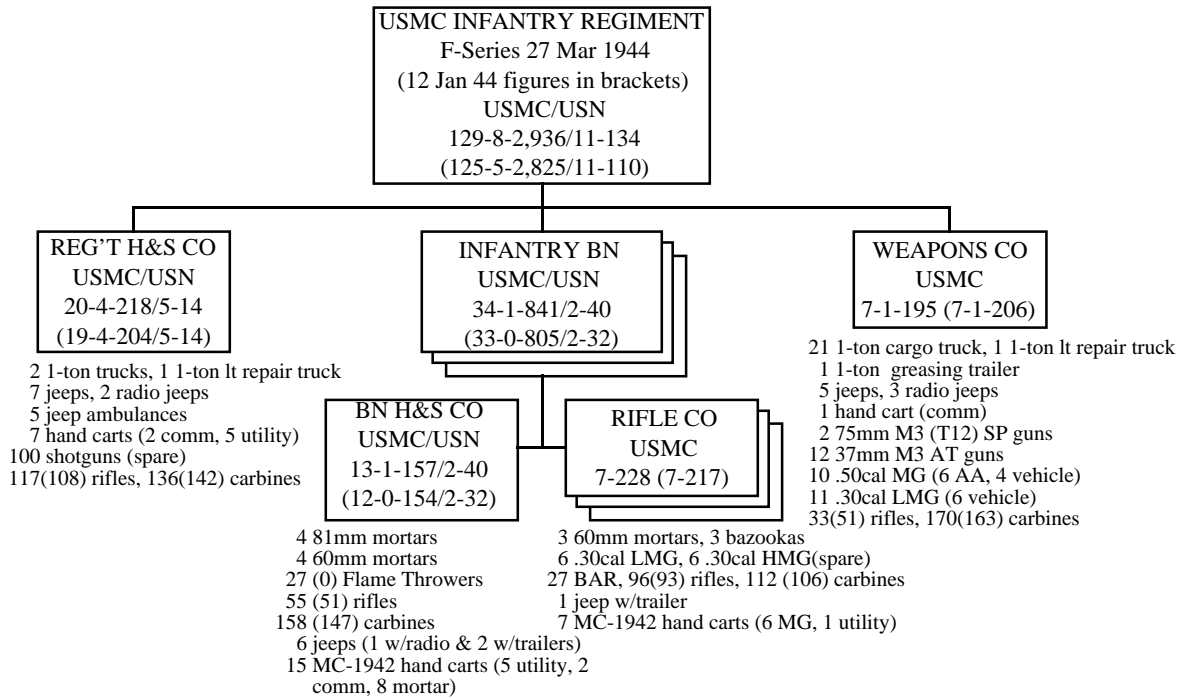

Notes:

Source: Marine Corps Table of Organization F-10 "Infantry Regiment, Marine Division" (HQMC Washington DC dated 12 January and 27 March 1944).

Appendix 5.35

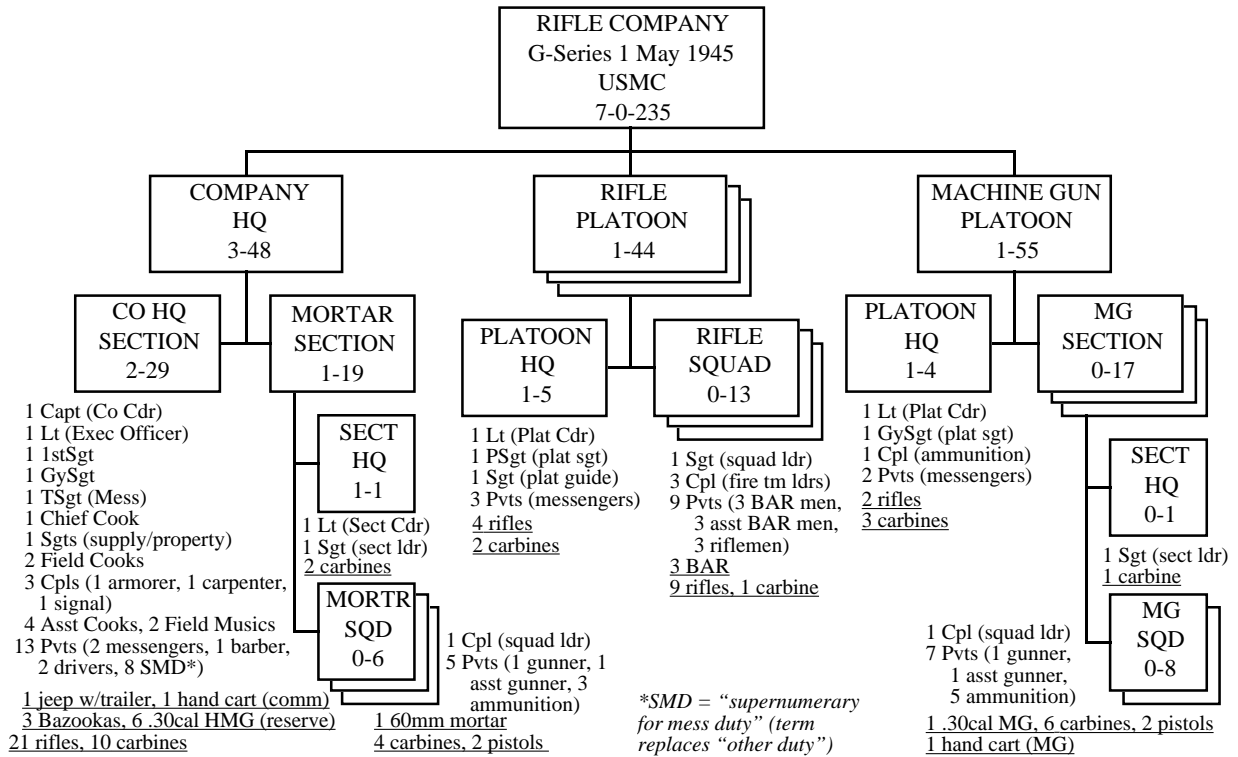

Notes:

**Small Arms:** In the company headquarters the officers, first sergeant, gunnery sergeant, chief cook, field musics, drivers and all mortar section personnel carry carbines. All others carry rifles. In the rifle platoons all personnel carry rifles except the platoon leaders, platoon sergeants, and rifle squad leaders who carry carbines and automatic riflemen who have BAR's. All machinegun platoon personnel carry carbines except gunners and assistant gunners who have pistols and two messengers who have rifles.

**Source:** Marine Corps Table of Organization G-1 "Rifle Company, Infantry Battalion, Infantry Regiment" (HQMC Washington DC dated 1 May 1945).

### Appendix 5.36

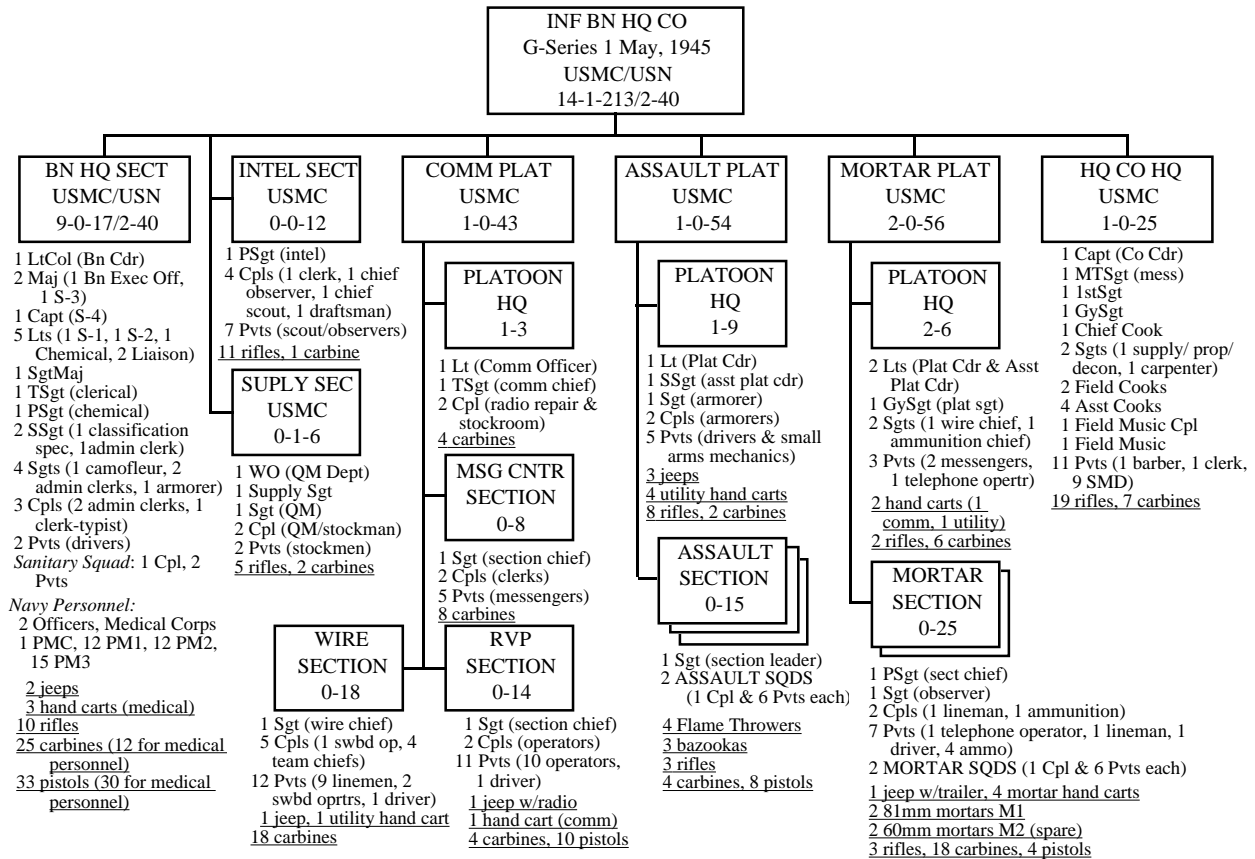

**Notes:**

**Small Arms:** Field grade officers (lieutenant colonels and majors) carry pistols. Company grade officers (captains and lieutenants), warrant officers, non-commissioned officers above the rank of sergeant, field musics, and drivers carry carbines. All communication platoon personnel carry carbines except for 10 privates (radio operators) in the radio, visual and panel (RPV) section who carry pistols. In the assault sections of the assault platoon the section and squad leaders carry rifles. The two bazooka operators and two flame-thrower operators in each squad carry pistols. The two demolition men carry carbines. In the mortar platoon all personnel carry carbines except two messengers, the mortar section observers and the mortar squad leaders (who have rifles) and the mortar gunners and assistant gunners (who have pistols).

**Assault Platoon:** Each assault squad had two bazooka operators who could operate one bazooka and two flame-thrower men who could operate one flame-thrower at a time. Thus, each section could operate two bazookas and two flame-throwers, leaving one bazooka and two flame-throwers per section as spares. The spare flame-throwers were necessary because they could be in the rear reloading while the other flame-throwers were in use. After the war the Marine Corps doubled the number of spare flame-throwers per assault section.

**Officer's Mess:** The battalion headquarters no longer operated an officers' mess under the G-Series tables. All cooks and other commissary personnel were consolidated in the headquarters company headquarters.

**Personnel Administration:** As in the F-Series Battalion, the G-Series battalion headquarters handled personnel administration for all four companies in the battalion. Four admin clerks (two sergeants and two corporals) each kept the records of one company under the supervision of two staff sergeants (an admin clerk and a classification specialist) and a technical sergeant.

**Source:** Marine Corps Table of Organization G-4 "Headquarters Company, Infantry Battalion, Infantry Regiment" (HQMC Washington DC dated 1May 1945)



Appendix 5.37

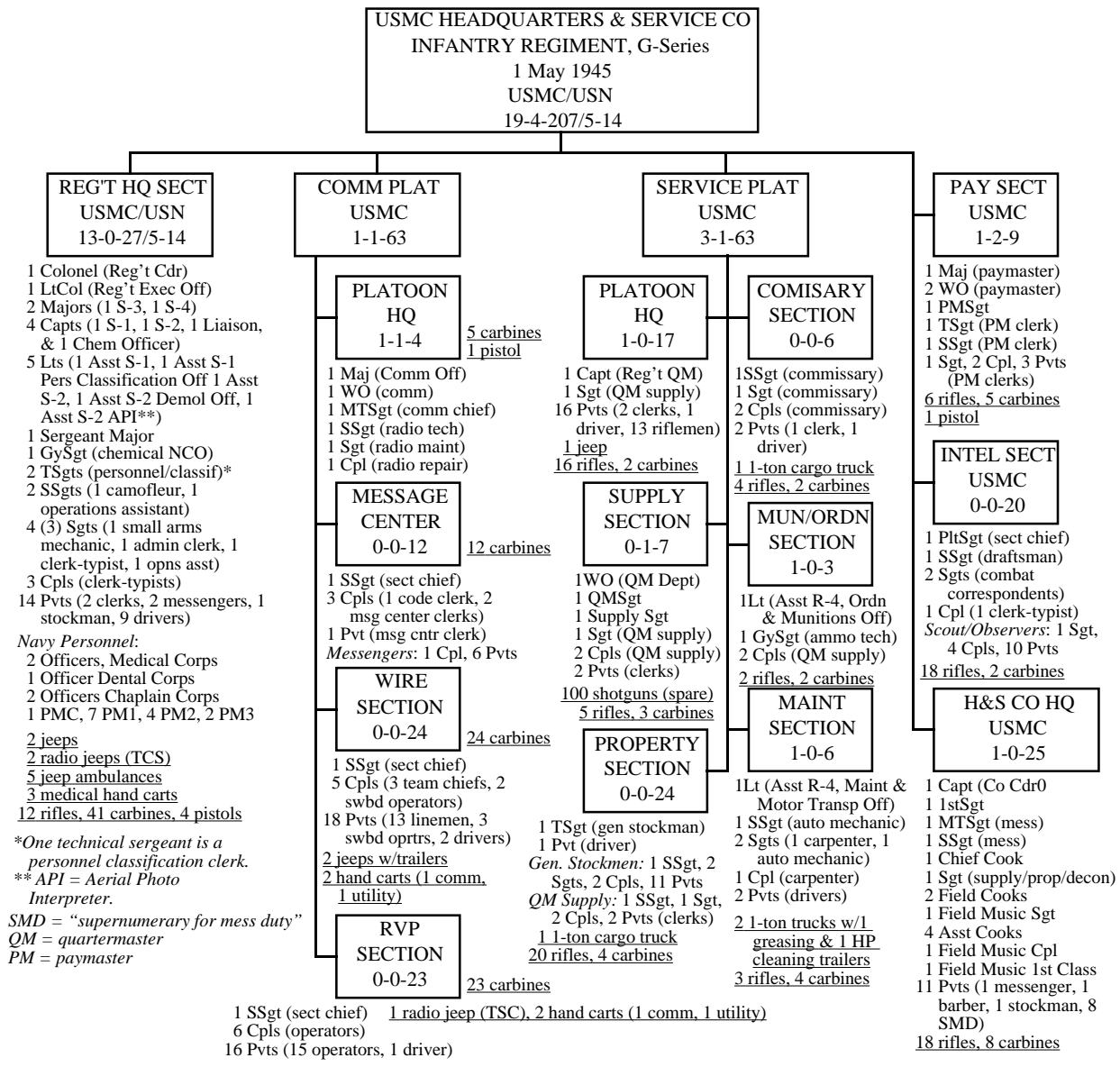

Notes:

**Small Arms:** Field grade officers (colonels, lieutenant colonels and majors) carried pistols. Company grade officers (captains and lieutenants), warrant officers, Non-commissioned officers ranking above sergeant, field musics, drivers and all communication platoon personnel (except the platoon commander) carried carbines. Carbines were also maintained for Navy medical and dental personnel.

**Officer's Mess:** There was no longer a separate regimental officers' mess, all mess and commissary personnel having been consolidated in the headquarters and service company headquarters.

**Medical:** Five pharmacist's mates 1<sup>st</sup> Class (PM1) were normally attached to the regimental weapons company.

**Source:** Marine Corps Table of Organization G-9 "Headquarters and Service Company, Infantry Regiment" (HQMC Washington DC dated 1 May 1945).

**Appendix 5.38**

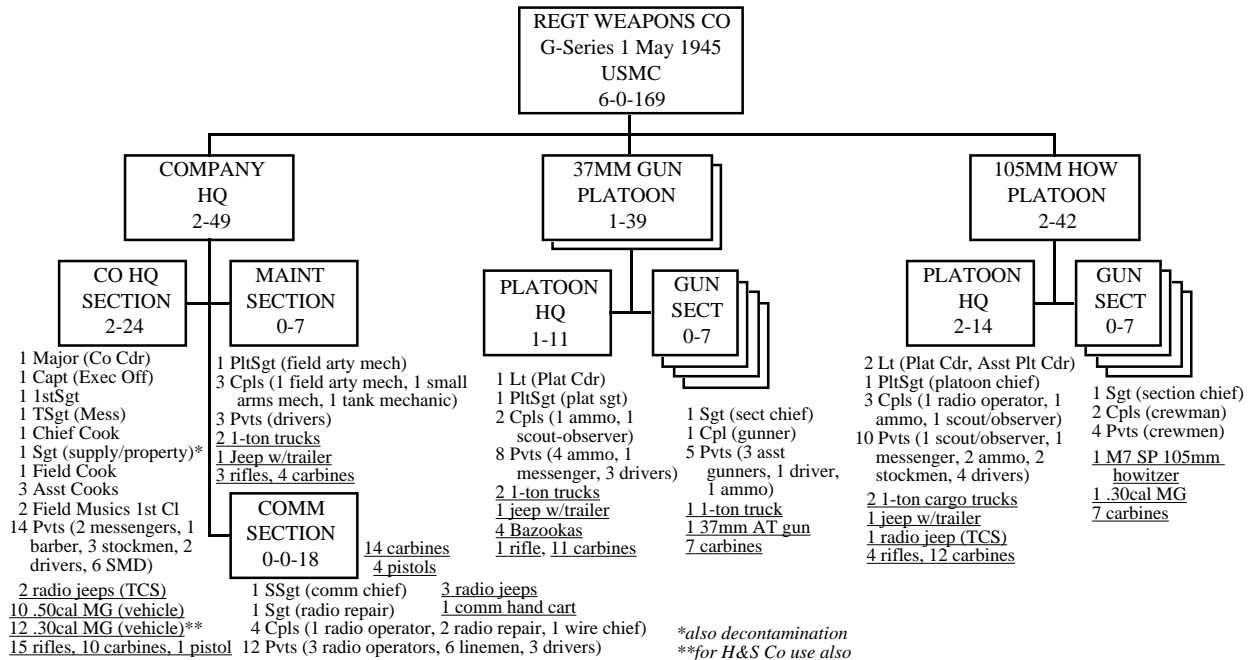

**Notes:**

**Small Arms:** In the company headquarters the company commander (a major) and four radio operators in the communication section carried pistols. The executive officer, non-commissioned officers ranking above sergeant, all other members of the communication section, the field musics, messengers, and drivers all carried carbines. All personnel in the 37mm gun platoon except one messenger (who carried a rifle) carried carbines. All 105mm howitzer platoon members also carried carbines except the two scout observers and two supply stockmen, who all carried rifles.

**Other Weapons:** The .30-caliber machineguns were intended for mounting on jeeps without radios for local security and convoy protection. They could be mounted on headquarters and service company jeeps as well as those of the weapons company. Six of the ten .50-caliber machineguns still had their anti-aircraft mountings though under the G-Series tables dedicated crews would no longer be provided for them. These and the other four guns were also available for mounting on one-ton trucks.

**Source:** Marine Corps Table of Organization G-7 "Weapons Company, Infantry Regiment" (HQMC Washington DC 1 May 1945).

### Appendix 5.39

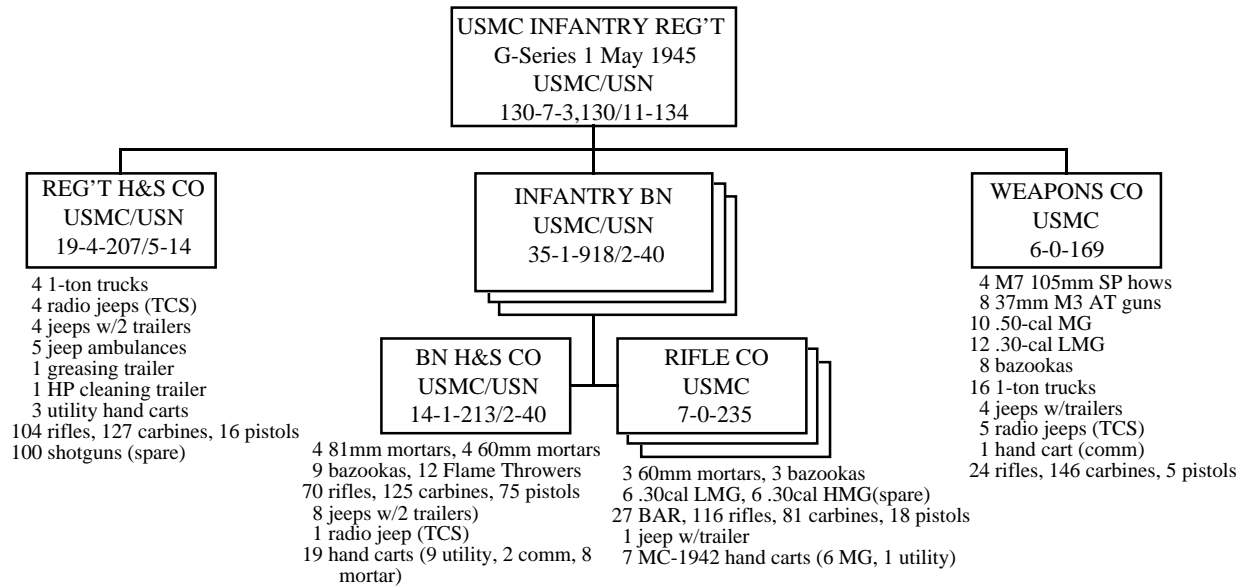

Notes:

Source: Marine Corps Table of Organization G-10 "Infantry Regiment, Marine Division" (HQMC Washington DC 1 May 1945).

Notes for the G and later series Marine Corps tables of organization: As most readers are aware both the US Army and Marine Corps have traditionally published two separate types of document to describe the organizations of their tactical units. One of these is, of course, the table of organization, which is concerned almost entirely with personnel. For information purposes but the Army and Marine Corps traditionally listed all of a unit's weapons and certain major equipment items (mainly vehicles) so that the reader would have a better idea of the capabilities of the unit being described. A complete listing of the unit's equipment, however, could only be found in what was called a table of basic allowances (TBA). The TBA was an enormous bound document that included excruciatingly detailed lists of equipment for all kinds of units. It was intended mainly for supply personnel so that they could maintain inventories and have authority to order the gear they needed. As units became more elaborately and expensively equipped the TBA became less practical as the sole source of what equipment a unit was allowed. In 1943 the US Army took a major step away from the TBA by publishing a Table of Equipment (TE) with each of its tables of organization. Since then Army unit equipment tables have become so closely integrated with their tables of organization that they are routinely referred to as "Tables of Organization and Equipment" or "TO&E."

Instead of moving to a TO&E system in 1943 the Marines moved in the opposite direction in 1945 when they published their "G-Series" tables with all equipment information (other than the personal weapons to be assigned to each man) removed. The TBA's (later renamed Tables of Equipment but without any substantive change) became the sole source of information on the equipment (even major items such as vehicles and crew served weapons) that Marine units were authorized. Though the Marine Corps Historical Section has been pretty successful in its efforts to preserve outdated tables of organization they have largely failed to preserve equipment allowance information, at least in a form that might be accessible to historians. The G-Series tables are a case in point. Many of the surviving TE and TBA documents are kept in a warehouse accessible to the records branch in Headquarters Marine Corps. Though this writer shamelessly abused his position as a Marine Reserve officer in order to get at these documents he discovered that all the World War II equipment data for the G-Series had been lost. There were some surviving tables from 1947 but though the G-Series still existed for wartime organizations, many changes had occurred since 1945, including the replacement of the Marines' original Navy trucks with standard Army vehicles. Appendix K of Volume V of the Marine Corps' official World War II history includes an incomplete list of equipment (though it does include weapons and vehicles) for a G-Series regiment in 1945. Doubtless it uses source material that is no longer available but it appears to contain some errors. The diagrams in Appendices 5.35 to 5.39 use this information with additional material from the 1947 tables and the older F-Series. It should be reasonably reliable though less so than the previous diagrams. Fortunately the Korean War era (K-Series) tables had survived. The Marine Corps Historical Center in the Washington Navy Yard still had a set of L-Series (post Korea) equipment tables.

Since then much equipment information has either been discarded or kept in computer files that, when updated usually erase the earlier information. For the equipment of Marine units since the 1960's this writer has had to rely on information circulars or training materials published by the Marine Corps, his own experience, and a few recent tables that he managed to get printed out.

## APPENDIX 6

### Appendix 6.1

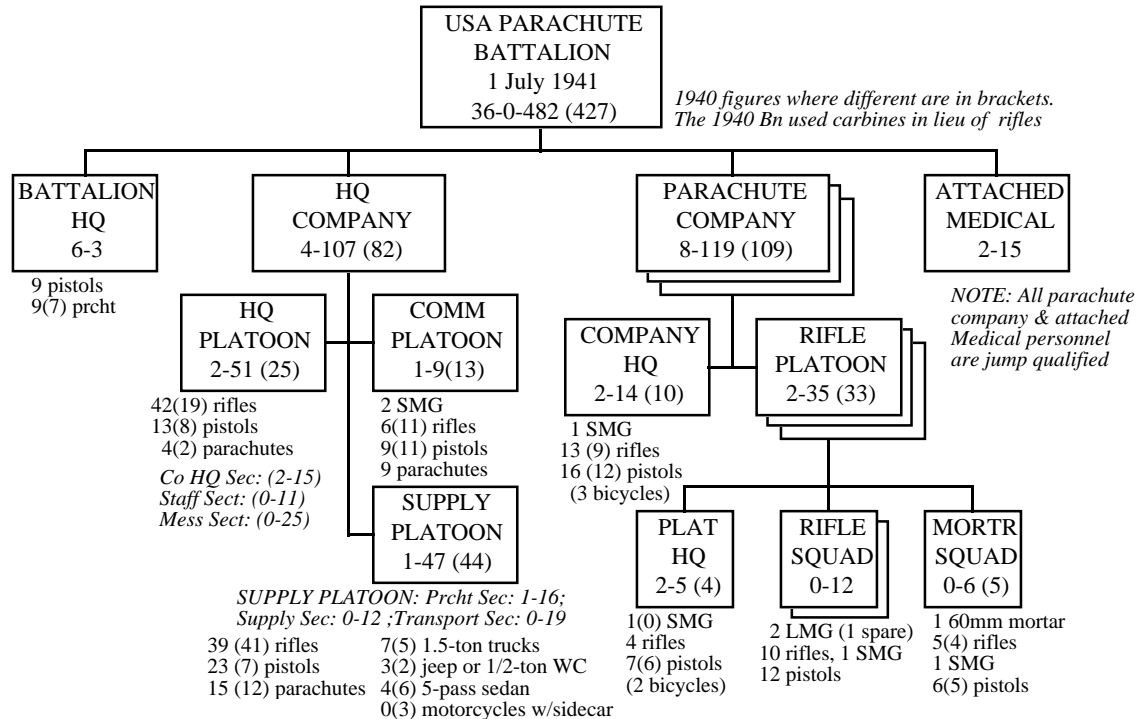

**Notes:**

The number of parachutists listed equals the total number of jump-qualified personnel.

**Rifle Company Personnel:** Both mortar and rifle squad leaders were sergeants and each rifle squad leader had a corporal to assist him. A rifle platoon headquarters included a signal corporal (added in 1941), a T-5 radio operator and two messengers. A rifle company headquarters included an operations sergeant, a communication sergeant, three radio operators (a T-3 and two T-4), three messengers and five spare riflemen (to help keep the rifle platoons up to strength).

**Battalion Headquarters:** This had a lieutenant colonel, a major, three captains (a combined S-1/S-2, an S-3 and an S-4 who also commanded the supply platoon), a first lieutenant (assistant adjutant) and three scout observers (two T-4 and a T-5).

**Headquarters Company:** Company headquarters included a captain, a first lieutenant, a first sergeant, three orderlies and 11 basic privates. A master sergeant (acting as battalion sergeant major) led the staff section, which included a technical sergeant and a sergeant for operations and a staff sergeant and four corporals for personnel. Two more corporals and a T-5 headquarters clerk provided additional clerical support. The communication platoon (under a lieutenant) had a technical sergeant, a message center (with a sergeant and a T-5 headquarters clerk), five radio operators (a sergeant and four T-3 privates), and a T-3 radio electrician. In the supply platoon the parachute section (under a lieutenant) was mainly riggers (a master sergeant, a technical sergeant and 12 corporals) but did include some supply personnel (a sergeant and T-4 record clerk). The supply section (under a technical sergeant and a staff sergeant) provided four company supply sergeants, an ammunition sergeant, three armorers (a T-4 and two T-5) and two record clerks (a corporal and a T-4). The transportation section under a staff sergeant provided 16 drivers (8 T-5) and two mechanics (a T-2 and a T-3).

**Medical:** The battalion medical detachment provided an aid station (with a staff sergeant, a corporal, a T-3 and six T-4 surgical techs, a T-4 medical tech and two basic privates) and a medic (T-5 surgical tech) for each rifle company. The two basic privates and probably some of the surgical techs acted as litter bearers.

**Parachute-Qualified Personnel:** These included all members of the battalion headquarters and the rifle companies. In the headquarters company all the officers, the operations chief and an operations sergeant (both in the staff section, headquarters platoon), all members of the communication platoon (except the radio electrician) and all members of the parachute section of the supply platoon (except a sergeant supply assistant and a T-4 record clerk).

**Source:** War Department Table of Organization 7-35 "Infantry Battalion, Parachute" (Washington DC 1 July 1941); for information on the battalion as it existed in 1940, see *Infantry Journal* staff, "The Tentative Parachute Battalion" *Infantry Journal* November-December 1940.

## Appendix 6.2

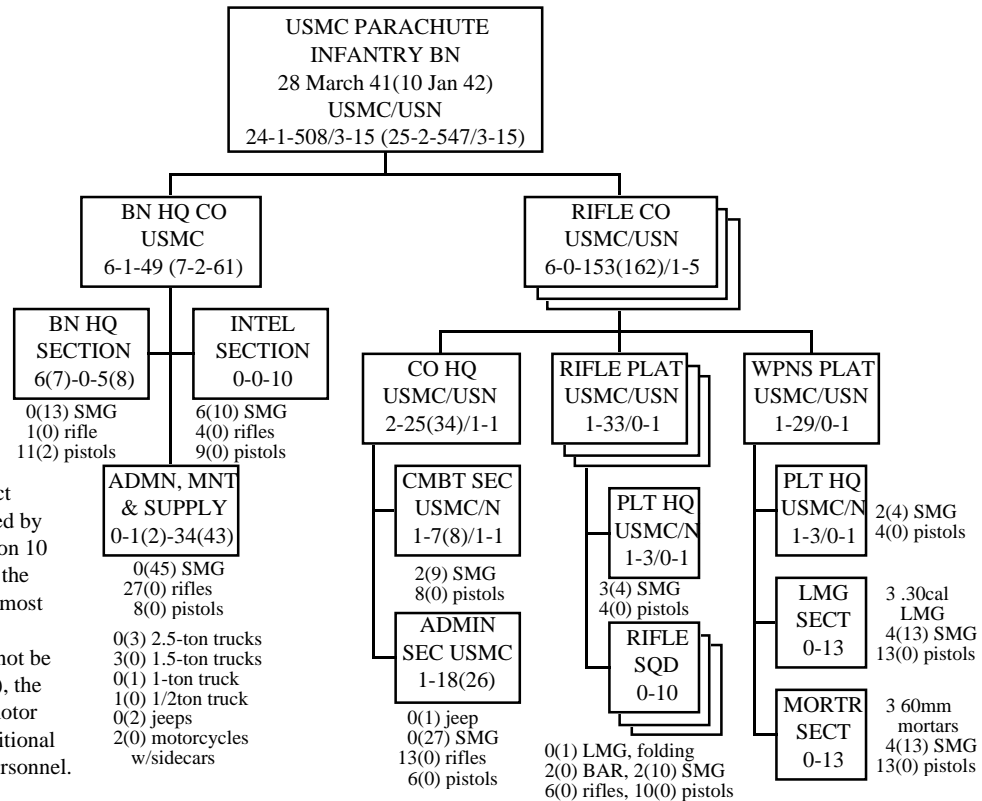

The figures in brackets reflect changes and additions ordered by Headquarters Marine Corps on 10 January 1942. This included the replacement of all rifles and most pistols with Reising sub-machineguns (which would not be available for several months), the updating of the battalion's motor transport equipment and additional supply and administrative personnel.

**Notes:**

**Rifle and Weapons Platoons:** Until the Reising guns were available, platoon sergeants (but not the gunnery sergeant who was platoon sergeant for the weapons platoon), messengers, machinegun and mortar section and squad leaders, rifle squad leaders (sergeants) and assistant squad leaders (corporals) were to carry Thompson sub-machineguns. The eight privates per squad were to carry six rifles and two BAR. Officers, the gunnery sergeants and mortar and LMG gunners would carry pistols.

**Rifle Company Headquarters:** The combat section of the company headquarters was to have the company commander, five radio operators (a corporal and four privates) and two messengers. The January 1942 update added an armorer. Except for the parachute riggers (who, together with the first sergeant, originally carried pistols) the administrative section had mostly non-jumping personnel and it constituted the company's ground echelon. It was led by the executive officer and had four riggers (a sergeant and three corporals), the company supply and property sergeant, the company mess team (a mess sergeant, a chief cook, a field cook, and an assistant cook), the company clerk (a corporal), four supply men and three "other duty" privates. The January update subtracted a supply man but added a radio maintenance sergeant (who was also a jumper) and a barber, a cobbler, a driver (for a company jeep) and five more "other duty" privates who were not.

**Battalion Headquarters:** The lieutenant colonel, major, the Bn-3 (a captain), the Bn-2 (a lieutenant) and two radio operators were jump qualified. The Bn-4 (a captain who also headed the ground echelon), the Bn-1 (a lieutenant who also commanded the headquarters company), two field musics (a corporal and a PFC) and an "other duty" private were not. The January 1942 changes added a jump-qualified communication officer and a non-qualified chief cook, an assistant cook and another "other duty" private.

**Battalion Headquarters Company:** The intelligence section (a platoon sergeant, sergeant, a draftsman (corporal), two clerks (a corporal and a private), four scouts (a corporal and three privates) and an "other duty" private) was jump qualified except for the "other duty" private. The sergeants and the scouts carried sub-machineguns. The administrative, maintenance, and supply section included the sergeant major and the battalion communication personnel (a staff sergeant, a message center chief and clerk (a sergeant and a private but only after January 1942), two radio maintenance men [a sergeant and a corporal], and radio operators [a corporal and two privates, three after January 1942]). It also included battalion mess and supply personnel (a warrant officer quartermaster clerk, a quartermaster sergeant, a staff sergeant (clerical), a sergeant (three after January 1942, an armorer a clerk, and the company supply sergeant), a corporal (clerk), a mess team (a staff sergeant, a field cook and an assistant cook), 8 supply men and (after January) a barber and a cobbler). Motor transport personnel included two mechanics (a sergeant and a corporal) and four drivers (six after January). The riggers were a warrant officer (only after January) a platoon sergeant and a corporal. There was also an "other duty" private (three after January). The rigger and communication personnel were jump qualified.

**Source:** Marine Corps Tables of Organization Number 56 "Parachute Company, Parachute Battalion, Marine Division" (HQMC Washington DC 7 March 1941); and numbers D-81 "Parachute Company, Parachute Battalion, Marine Division" and D-82 "Headquarters Company, Parachute Battalion, Marine Division" (HQMC Washington DC 28 March 1941 and 10 January 1942).

Appendix 6.3

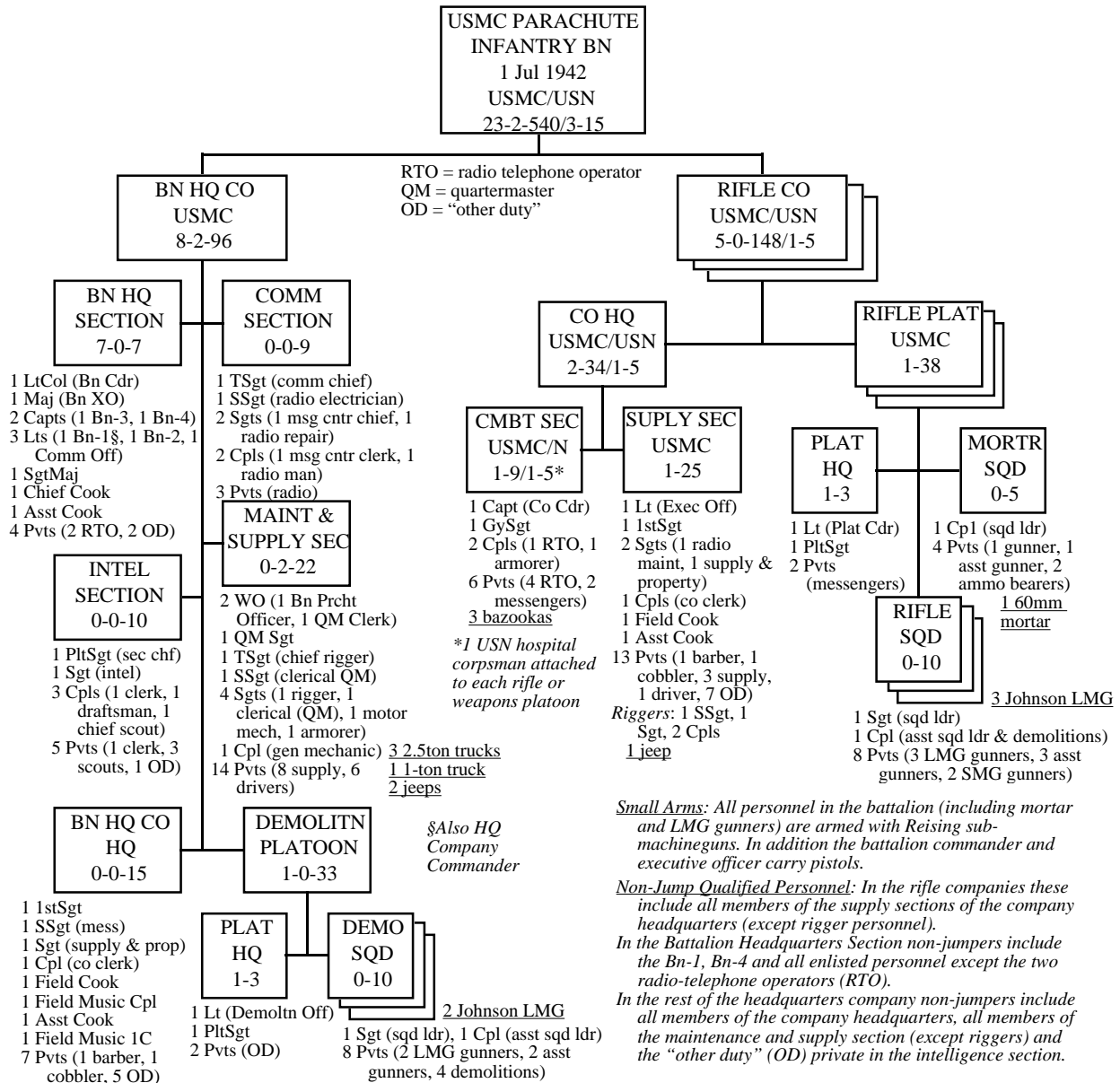

Notes:

Source: Marine Corps Tables of Organization numbers D-81 "Parachute Company, Parachute Battalion, Marine Division" and D-82 "Headquarters Company, Parachute Battalion, Marine Division" (HQMC Washington DC 1 July 1942).

Appendix 6.4

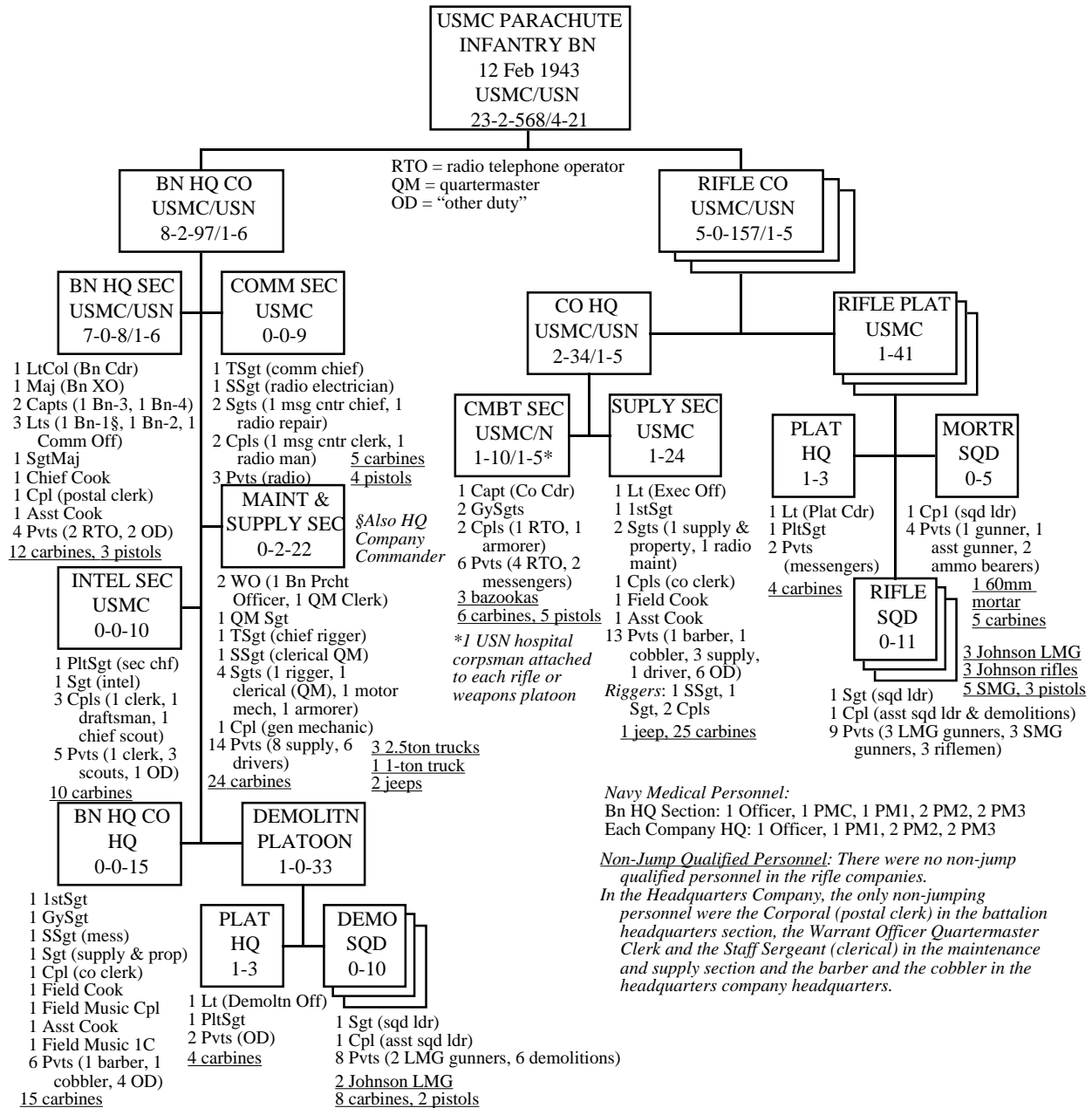

Notes:

Source: Marine Corps Tables of Organization D-315 "Parachute Company, Parachute Battalion, Parachute Regiment" and D-316 "Headquarters Company, Parachute Battalion, Parachute Regiment" (HQMC Washington DC 12 February 1943).

## Appendix 6.5

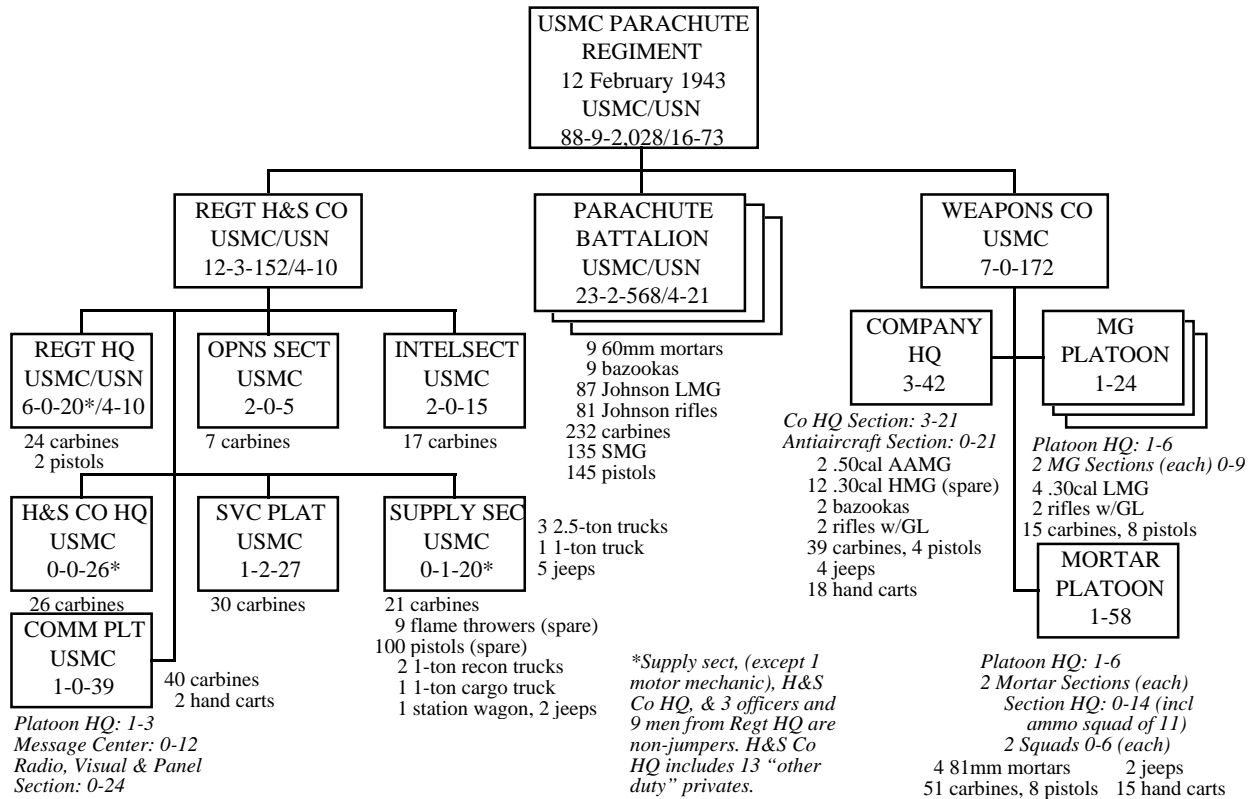

**Notes:**

**Weapons Company:** A major commands the weapons company and he has a captain as executive officer and a lieutenant as reconnaissance officer. Company headquarters includes an antiaircraft section under a platoon sergeant with two water-cooled .50-caliber machineguns (each manned by a corporal and two privates) and an ammunition squad (a corporal and eight men). The regimental headquarters provided five Navy Hospital Corpsmen for the weapons company.

**Regimental Headquarters and Service Company:** The regimental headquarters had the colonel, lieutenant colonel, two captains (the R-1 and the R-4, both non-jumping), and two lieutenants (a non-jumping assistant R-1 who was also H&S company commander and a jump-qualified assistant R-4 munitions officer). Other regimental staff officers were to be found in the operations section (including the R-3, a major and his assistant, a lieutenant) and the intelligence section (including a captain R-2 and a lieutenant photo interpreter). The rest of the intelligence section included a photographer (sergeant), draftsman (staff sergeant), and 10 scout-observers. A captain (regimental communication officer) commanded the communication platoon and a lieutenant commanded the service platoon, which included a warrant officer for parachute maintenance and repair, a warrant officer salvage officer, 24 riggers under a master technical sergeant and three armorers. The supply section included a warrant officer quartermaster clerk, two quartermaster sergeants, four other clerks, seven supply men, a mechanic and six drivers.

**Source:** Marine Corps Tables of Organization numbers D-320 "Parachute Regiment," D-319 "Headquarters and Service Company, Parachute Regiment" and D-318 "Weapons Company, Parachute Regiment" (HQMC Washington DC 12 Feb 1943).



## Appendix 6.6

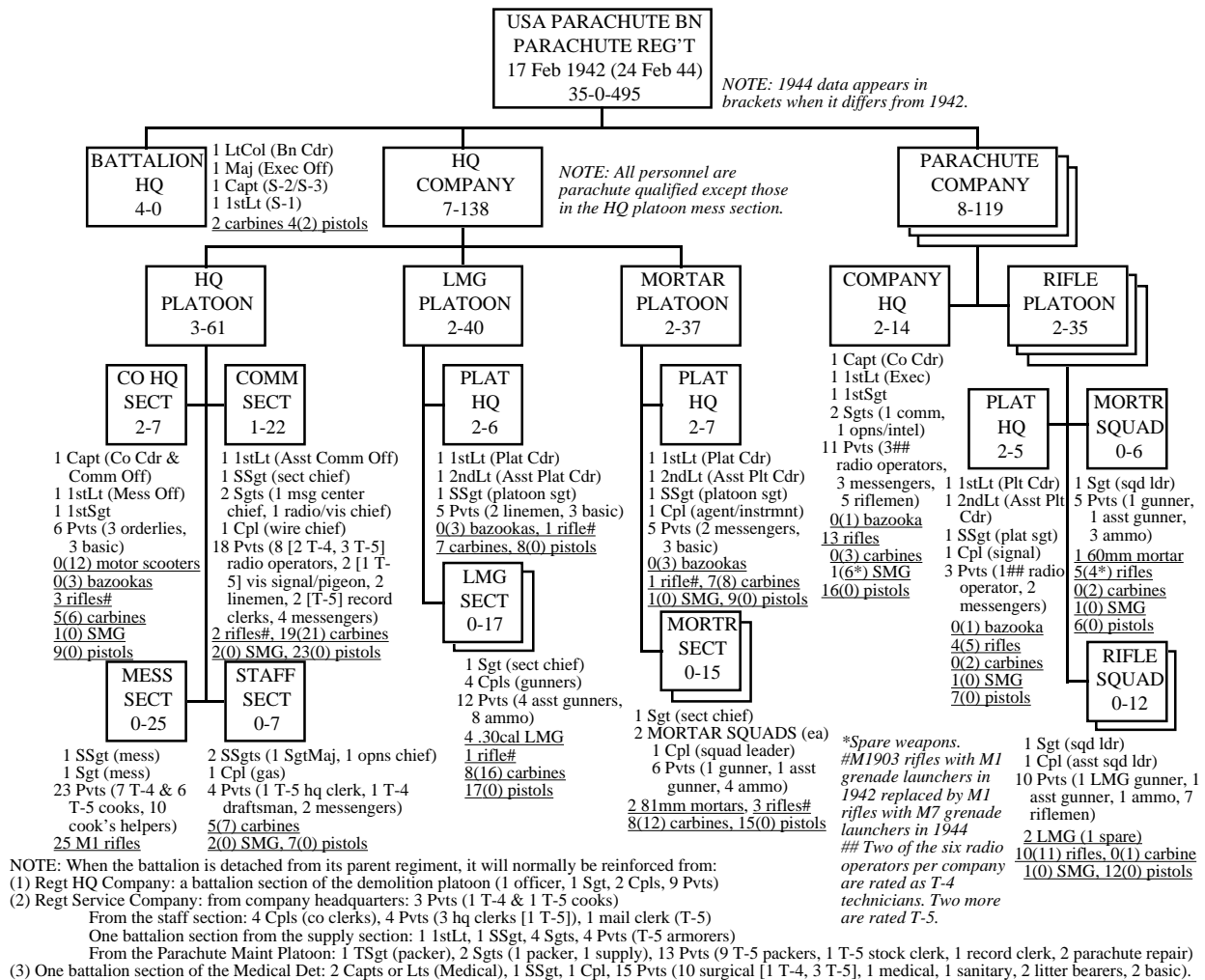

**Notes:**

**Parachute-Qualified Personnel:** All personnel in the battalion are parachute-qualified except the members of the mess section.

**Small Arms:** The tables authorized pistols for all jump-qualified personnel up until February 1944. Many continued to carry pistols "unofficially" after that. Prior to February 1944, M1903 rifles with grenade launchers were issued to one rifleman per rifle squad, the three orderlies in headquarters company headquarters, to one clerk and a pigeonier in the battalion communication section, to LMG and 81mm mortar section leaders, the platoon sergeant of the LMG platoon and the instrument corporal in the mortar platoon. Prior to February 1944, sub-machineguns were authorized for assistant rifle squad leaders, 60mm mortar squad leaders, rifle platoon sergeants and rifle company first sergeants. In the headquarters company sub-machineguns went to the first sergeant, the gas corporal and the headquarters clerk in the staff section and to the message center chief and a record clerk in the communication section. After February 1944 carbines replaced most pistols and sub-machineguns though in each rifle squad the assistant squad leader received a rifle and the LMG gunner received a carbine.

**Enlisted Ranks:** See the comments under Appendix 5.1. The private men in the battalion included 32 with technician ratings (four in each rifle company and the rest in the headquarters company) and 177 PFC (46 per rifle company).

**Source:** War Department Tables of Organization 7-35 "Infantry Parachute Battalion," 7-36 "Infantry Headquarters and Headquarters Company, Battalion Parachute" and 7-37 "Infantry Rifle Company, Parachute" (Washington DC 17 February 1942 with changes to 24 February 1944).

Appendix 6.7

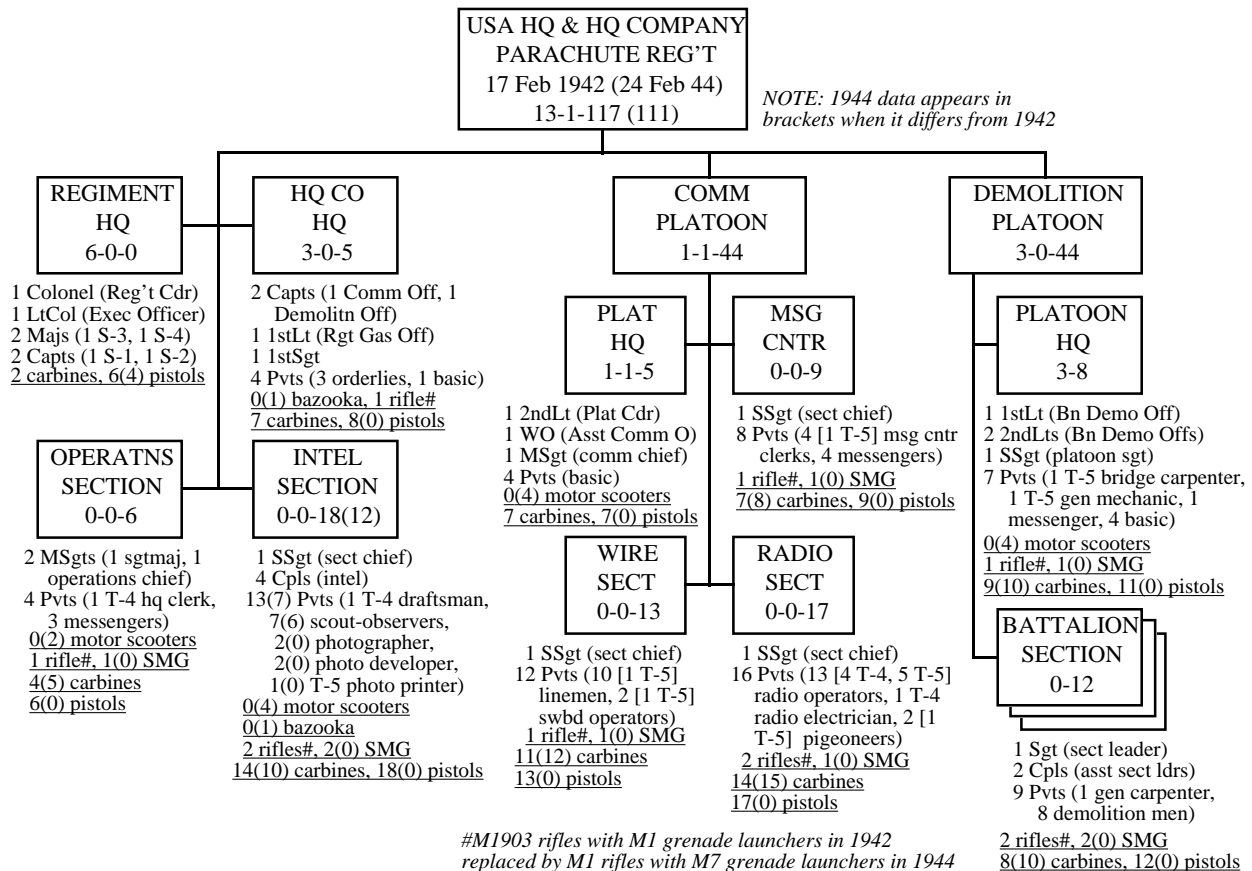

Notes:

The communication officer in company headquarters was also the headquarters company commander. The demolition officer also commanded the demolition platoon. As in a standard infantry regiment the first lieutenant regimental gas officer was also the headquarters company executive officer. The three officers in the demolition platoon would each accompany a demolition section whenever it was attached to one of the regiment's battalions and would serve as that battalion's demolition officer. The regimental demolition officer and demolition platoon commander was a captain who resided in the headquarters company headquarters

**Parachute-Qualified Personnel:** All members of the company are parachute qualified.

**Small Arms:** The tables authorized pistols for all jump-qualified personnel up until February 1944. Many continued to carry pistols "unofficially" after that. By February 1944 the availability of the M7 grenade launcher made it possible to replace the M1903 rifles with M1 rifles. The M1903 rifles had gone to one orderly in the headquarters company headquarters, one messenger in the operations section, two scout-observers in the intelligence section, one clerk in the message center of the communication platoon, one switchboard operator in the wire section, the two pigeoneers in the radio section, the platoon sergeant of the demolition platoon and the two corporals in each battalion demolition section. Also until February 1944, the headquarters clerk in the operations section, two scout-observers in the intelligence section, the message center, wire and radio section chiefs in the communication platoon, the bridge carpenter in the demolition platoon headquarters and two demolition men in each battalion demolition section carried sub-machineguns. Carbines replaced all sub-machineguns thereafter.

**Enlisted Ranks:** See the comments under Appendix 5.1. The private soldiers included 19 with technician ratings (only 18 after February 1944) and 33 PFC (31 PFC after February 1944).

Source: War Department Table of Organization 7-32 "Infantry Headquarters and Headquarters Company, Regiment Parachute" (Washington DC 17 February 1942 with changes to 24 February 1944).

## Appendix 6.8

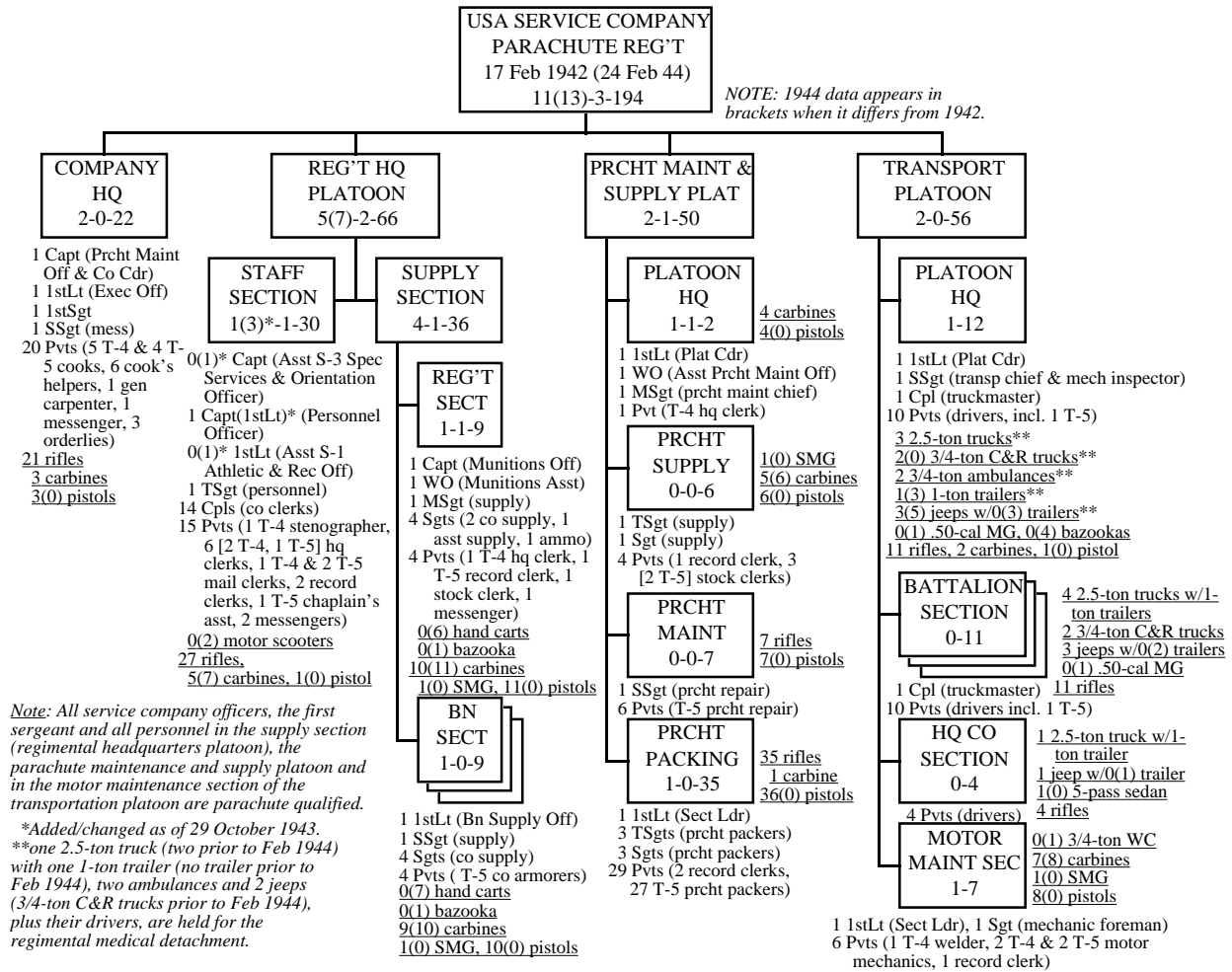
**PRCHT PACKING**  
 1-0-35
 
**PRCHT**  
 T-5 PRCHT REPAIR
 
**PRCHT**  
 T-5 PRCHT PACKERS
 

**TRANSPORT PLATOON**  
 2-0-56

**PLATOON HQ**  
 1-12

1 1stLt (Plat Cdr)  
 1 SSgt (transp chief & mech inspector)  
 1 Cpl (truckmaster)  
 10 Pvts (drivers, incl. 1 T-5)  
 3 2.5-ton trucks\*\*  
 2(0) 3/4-ton C&R trucks\*\*  
 2 3/4-ton ambulances\*\*  
 1(3) 1-ton trailers\*\*  
 3(5) jeeps w/0(3) trailers\*\*  
 0(1) .50-cal MG, 0(4) bazookas  
 11 rifles, 2 carbines, 1(0) pistol

**BATTALION SECTION**  
 0-11
 
**HQ CO SECTION**  
 0-4
 
**MOTOR MAINT SEC**  
 1-7
 

**Notes:**

In the transportation platoon the three battalion sections and the headquarters company section each include a relief driver.

**Small Arms:** The tables authorized pistols for all jump-qualified personnel up until February 1944. Many continued to carry pistols "unofficially" after that. Until February 1944 the sergeant supply assistant in the regimental section, the supply staff sergeant in each battalion section of the supply section, regimental headquarters platoon, and the section chief of the parachute supply section carried sub-machineguns. In the transportation platoon the sergeant mechanic foreman in the maintenance section also carried a sub-machinegun. Carbines replaced all sub-machineguns after February 1944. Where not otherwise noted carbines were issued to all officers, warrant officers, the first sergeant, two record clerks in the staff section and the platoon sergeant of the transportation platoon.

**Parachute-Qualified Personnel:** All commissioned officers, the company first sergeant, all members of the supply section of the headquarters platoon, all members of the parachute maintenance and supply platoon and all members of the motor maintenance section of the transportation platoon.

**Enlisted Ranks:** See the comments under Appendix 5.1. The private men in the company included 76 with technician ratings and 32 PFC.

**Source:** War Department Table of Organization 7-33 "Infantry Service Company, Regiment Parachute" (Washington DC 17 February 1942 with changes to 24 February 1944).

## Appendix 6.9

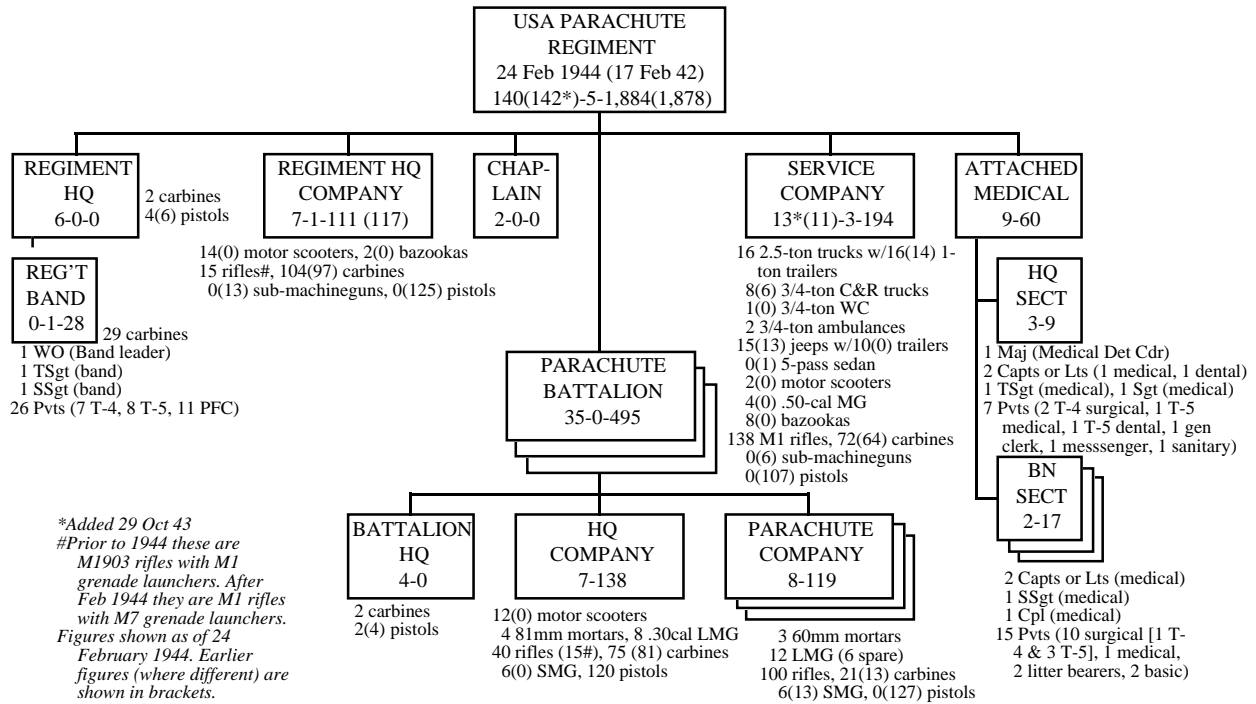

**Notes:**

**Medical:** A battalion section was the same size as the medical detachments assigned to the original separate parachute battalions. The tables for the parachute regiment did not specify the number of “medics” (surgical techs) to be assigned to each rifle company but those for the separate battalions said that there would be only one medic per company even though there were enough in the detachment to assign two or even three per company. However, unlike the Marine Corps the Army’s emphasis for the treatment of casualties was on rapid evacuation not rapid treatment (or first aid). For the Army it was more important to have enough litters to get the wounded off the battlefield as soon as possible than it was to have a medic come to a man’s aid as soon as he fell. By contrast, the Marine approach was (and still is) to treat now and improvise a litter team later.

**Regimental Band:** A parachute regiment, when authorized, can include a regimental band. When a band exists the regimental adjutant (S-1) commands it and it is attached to the service company for mess, supply and administrative purposes. A band consists of a warrant officer, a technical sergeant, a staff sergeant, seven T-4 technicians, eight T-5 technicians and 11 PFC, all armed with carbines. Tables of organization published after 1942 did not include infantry regimental bands since the Army had adopted a policy of supplying one band per division and attaching it to division headquarters.

**Source:** War Department Table of Organization 7-31 “Infantry Parachute Regiment” (Washington DC 17 February 1942 with changes to 24 February 1944).

Appendix 6.10

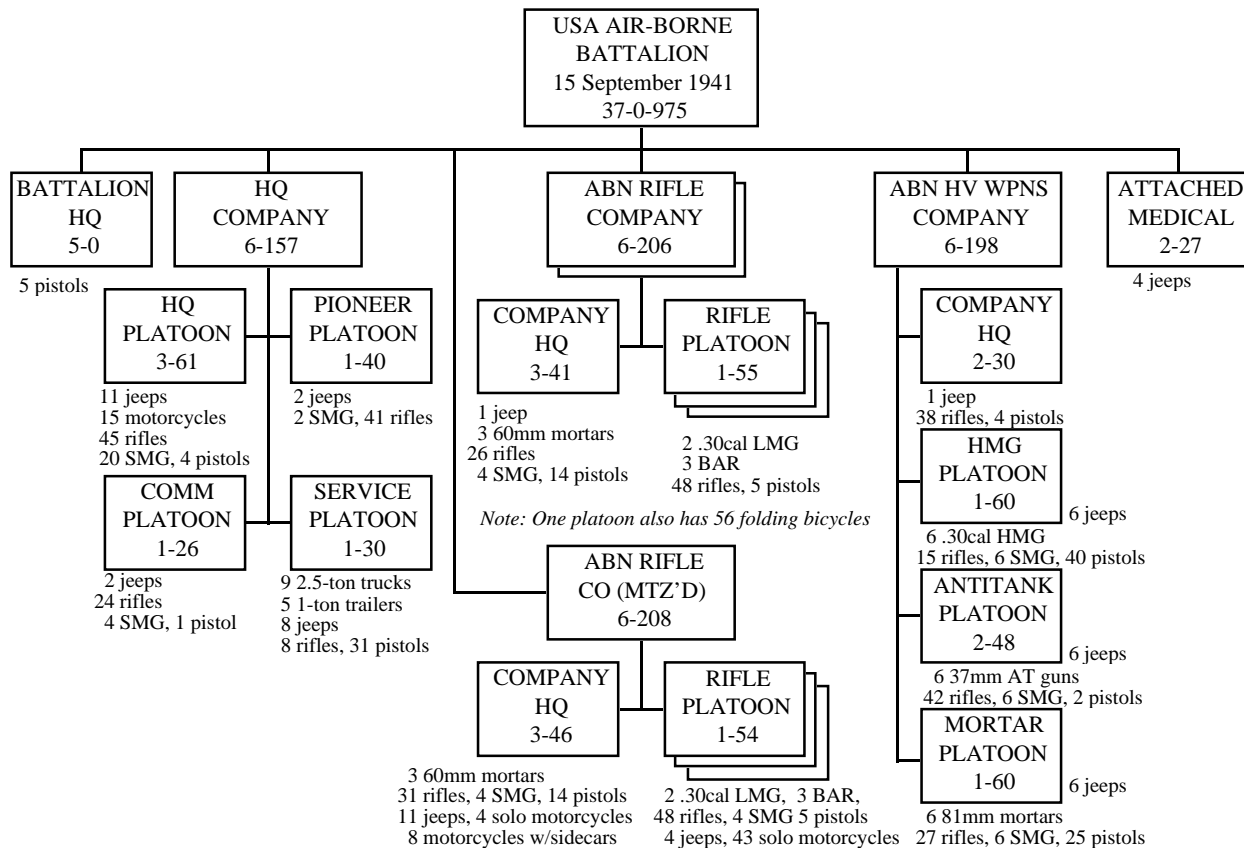

Notes:

**Headquarters Company:** Headquarters platoon includes a company headquarters section (one officer, 30 men including 11 basic privates); a staff section (eight men), a supply section (two officers and eight men) and a reconnaissance and intelligence section (15 men, including a sergeant draftsman, two corporals and 12 scouts, all with motorcycles). The pioneer platoon had three 12-man operating sections. The service platoon included a maintenance section (13 men and four jeeps) and a transportation section (15 men, 9 2.5-ton trucks and three jeeps).

**Rifle Companies:** A rifle platoon has three 12-man squads and a 10-man LMG squad. Company headquarters includes a 60mm mortar section with an officer and 20 men (three five-man squads and a section headquarters that includes two basic privates). In a motorized company a rifle platoon headquarters has (besides a platoon sergeant and a platoon guide) a driver, two messengers (one with a motorcycle) and three motorcycle men in lieu of two messengers and five basic privates. Company headquarters includes four motorcycle mechanics and a motor mechanic besides four messengers, two radio operators, an orderly, a bugler, an armorer, and seven cooks and cook's helpers.

**Weapons Company:** The HMG platoon has three 17-man (two eight-man squads) sections besides a headquarters that includes three basic privates, two messengers, three corporals (two instrument and one transport) and a platoon sergeant. The 81mm platoon is organized the same way. The 37mm gun platoon has only 13 men (two six-man squads) per section.

**Source:** War Department Tables of Organization 7-45 "Infantry Air-borne Battalion;" 7-46 "Infantry Headquarters and Headquarters Company, Infantry Air-borne Battalion;" 7-47 "Infantry Rifle Company, Air-borne;" 7-48 "Infantry Heavy Weapons Company, Air-borne;" and 7-49 "Infantry Rifle Company (Motorized), Air-borne" (all Washington DC 15 September 1941).

## Appendix 6.11

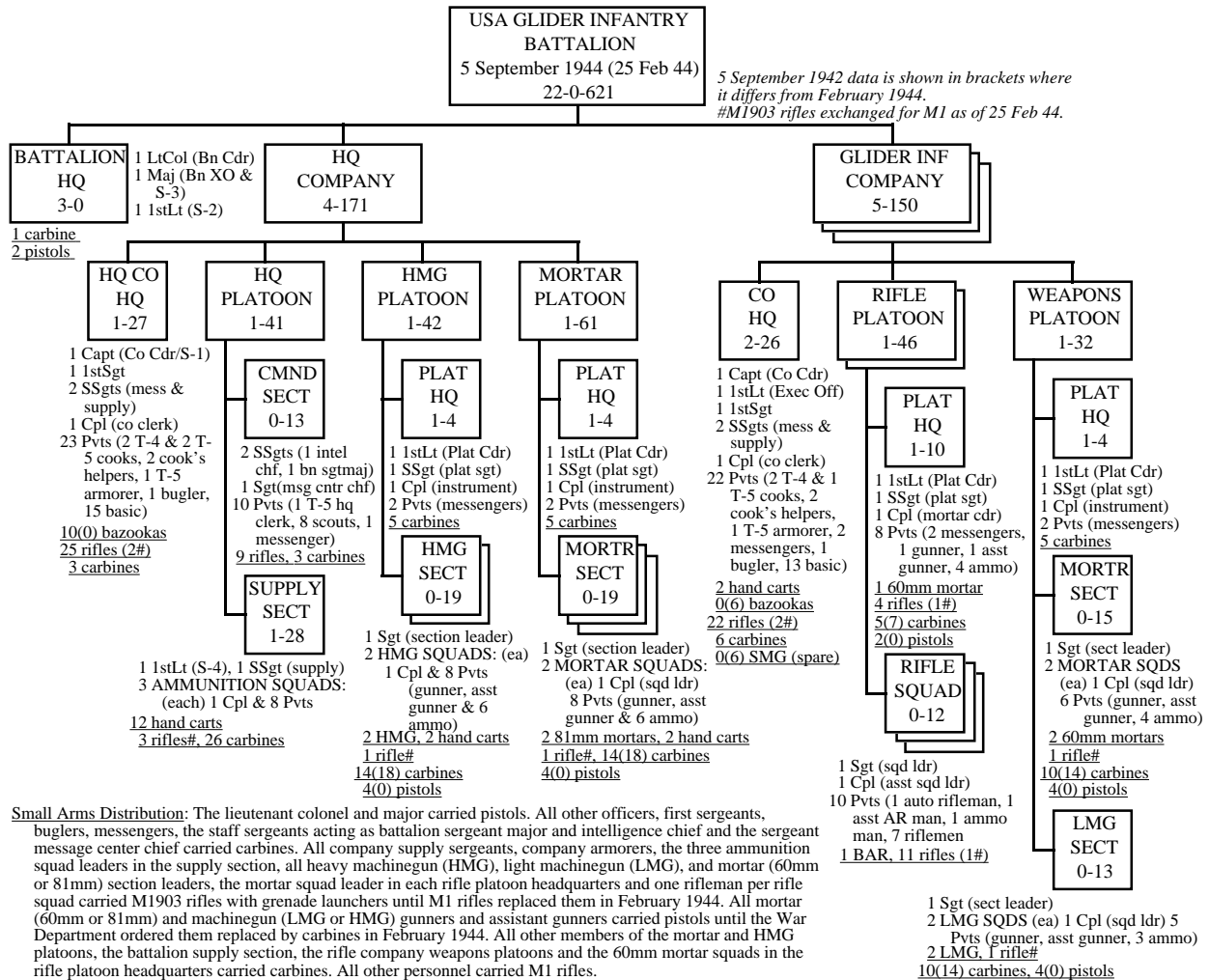

**Notes:**

**Enlisted Ranks:** The private soldiers in the headquarters company included six with technician ratings and 60 PFC. The private soldiers in each rifle company included four technicians and 53 PFC.

**Source:** War Department Tables of Organization 7-55 "Glider Infantry Battalion;" 7-56 "Headquarters and Headquarters Company, Glider Infantry Battalion;" 7-57 "Glider Infantry Company" (all Washington DC 5 September 1942 plus changes dated 25 February 1944).

## Appendix 6.12

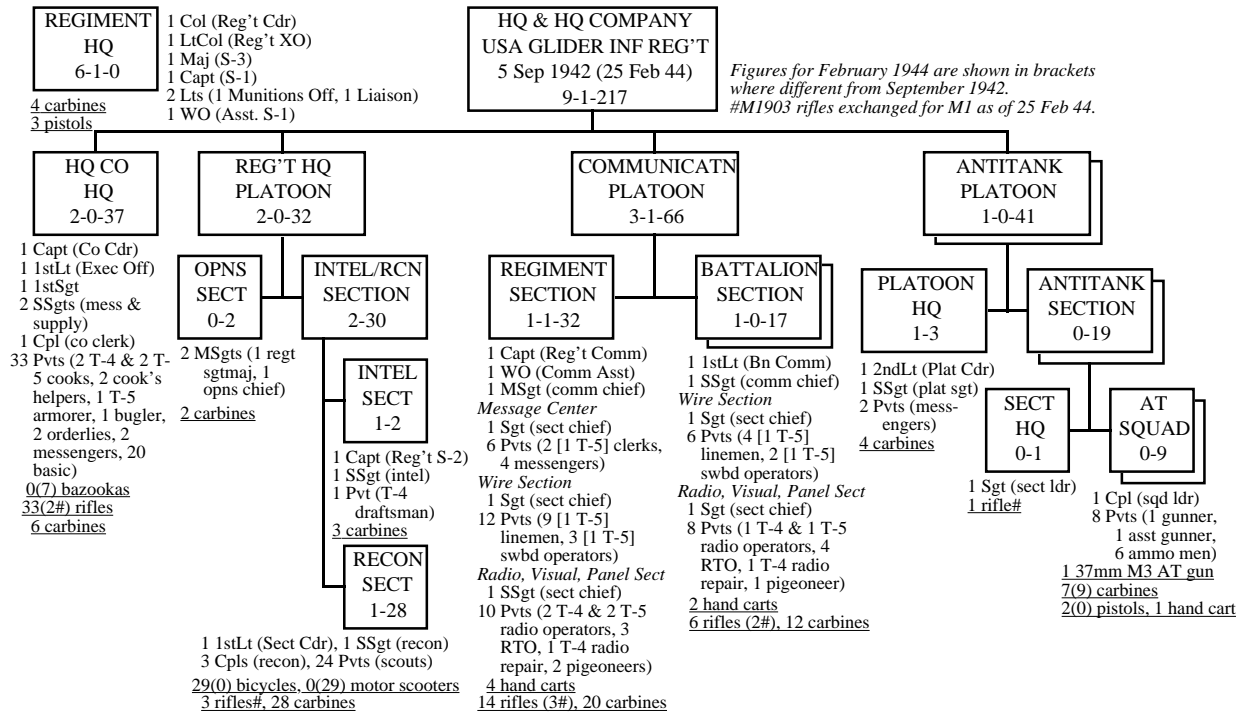

**Notes:**

**Small Arms Distribution:** The major, lieutenant colonel and colonel (regimental headquarters) and (until February 1944 when they received carbines instead) the gunners and assistant gunners in the antitank platoons carried pistols. In the headquarters company headquarters the officers, first sergeant, bugler and messengers carried carbines. The staff sergeant (supply) and the armorer carried M1903 rifles with grenade launchers (replaced in February 1944 by M1 rifles). All others in the company headquarters carried M1 rifles. In the rest of the company the three corporals in the reconnaissance section, the switchboard operators in the communication platoon and the section leaders in the two antitank platoons carried M1903 rifles. All other personnel in the regimental headquarters platoon and the antitank platoons carried carbines. Information is more sketchy on the communication platoon but it appears that the members of the wire sections (except the section chiefs) and the message center clerks all carried rifles. All other members of the platoon carried carbines.

**Enlisted Ranks:** The private soldiers in the company included 24 with technician ratings and 69 PFC.

**Source:** War Department Tables of Organization 7-51 "Glider Infantry Regiment;" 7-52 "Headquarters and Headquarters Company, Glider Infantry Regiment" (all Washington DC 5 September 1942 with changes dated 25 February 1944). Readers should note that copies of the original Table 7-52 were not available at any Army research facilities that this writer visited although copies of the February 1944 changes were available. Since the changes were fairly extensive and a good deal of the data on the original tables had to be included so the changes could be tracked this writer has been able to reconstruct the 7-52 Table as shown above. The use of Table 7-51 also ensured that manpower (including ranks and technician ratings) and equipment totals would be correct. He is fairly confident that the data it contains is generally accurate, though there probably some exceptions.

Appendix 6.13

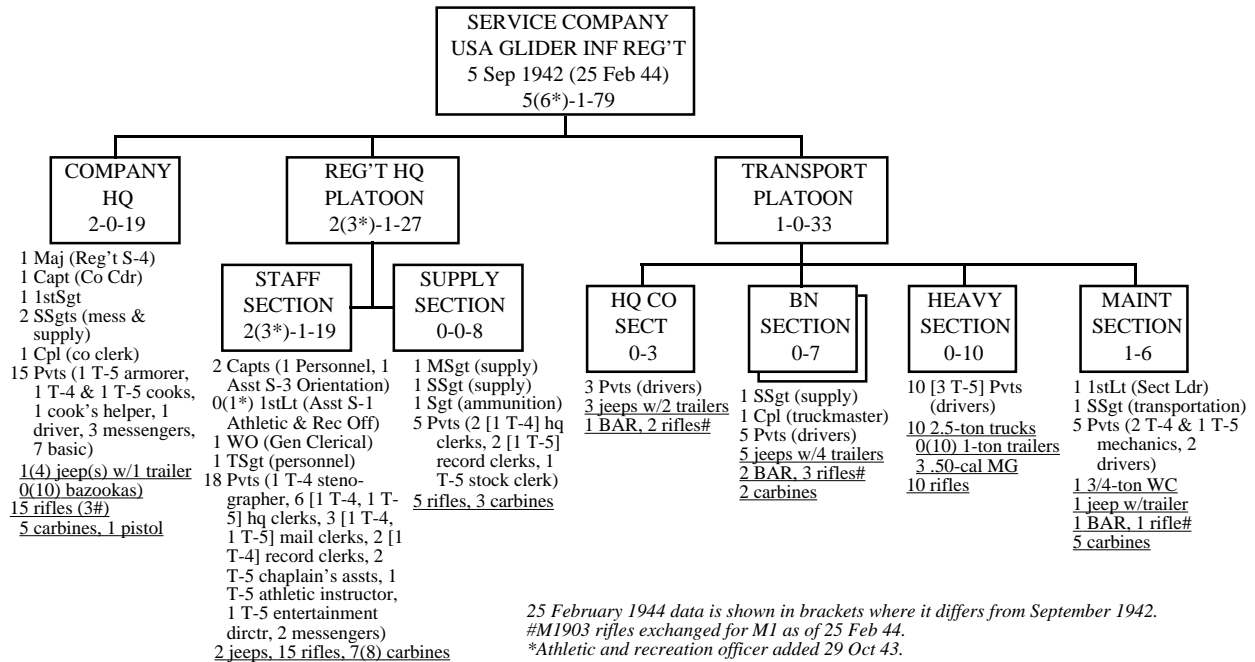

Notes:

**Small Arms Distribution:** The major, regimental S-4 carried the only pistol. The staff sergeant (supply), the armorer, and the driver in company headquarters and selected drivers in the transportation platoon (including the maintenance section) all carried M1903 rifles with grenade launchers (replaced by M1 rifles by February 1944) for antitank defense when using M9 or M10 grenades. All officers and warrant officers (except the major), plus the first sergeant, technical sergeant, master sergeant, all staff sergeants (except the two in company headquarters), all messengers, mechanics, the ammunition sergeant (supply section), corporal truck-masters, and the stenographer carried carbines. Six drivers in the transportation platoon carried automatic rifles (BAR) for anti-aircraft defense. All others carried M1 rifles.

**Enlisted Ranks:** The private soldiers in the company included 22 with technician ratings and 19 PFC.

**Source:** War Department Table of Organization 7-53 "Service Company, Glider Infantry Regiment" (Washington DC 5 September 1942 with changes to 25 February 1944).



Appendix 6.14

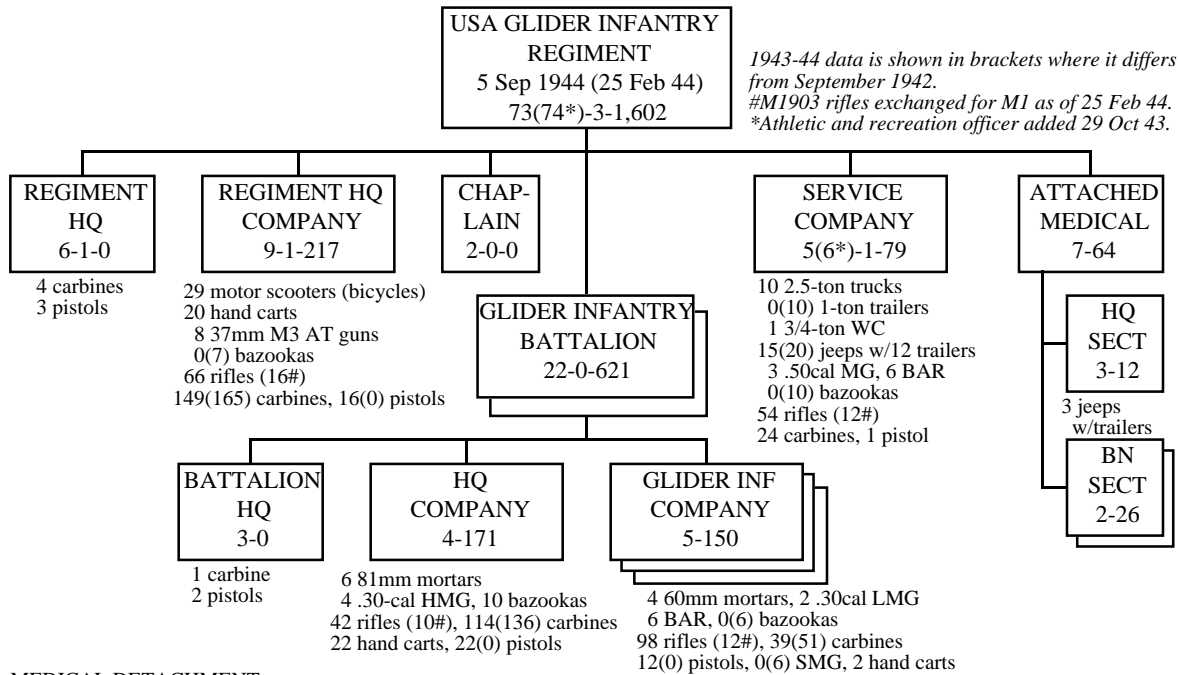

**MEDICAL DETACHMENT**

Headquarters: 1 Maj (Det Cdr), 2 Capts or 1stLts (1 Medical, 1 Dental), 1 TSgt (medical), 1 Sgt (medical), 10 Pvts (2 surgical techs [T-4], 1 dental tech [T-5], 1 medical tech [T-5], 1 sanitary tech, 1 gen clerk, 1 messenger, 3 drivers)

2 Battalion Sections (each): 2 Capts or 1stLts (Medical), 1 SSgt (medical), 1 Cpl (medical), 24 Pvts (8 surgical techs [1 T-4 & 3 T-5], 2 medical techs [1 T-5], 12 litter bearers, 2 basic)

**Notes:**

Medical Detachment: Each battalion section has sufficient medics (surgical techs or aidmen) to assign two per glider infantry company or one per rifle platoon.

Source: War Department Tables of Organization 7-51 "Glider Infantry Regiment;" and 7-55 "Glider Infantry Battalion" (both Washington DC 5 September 1942 with changes dated 25 February 1944).

## Appendix 6.15

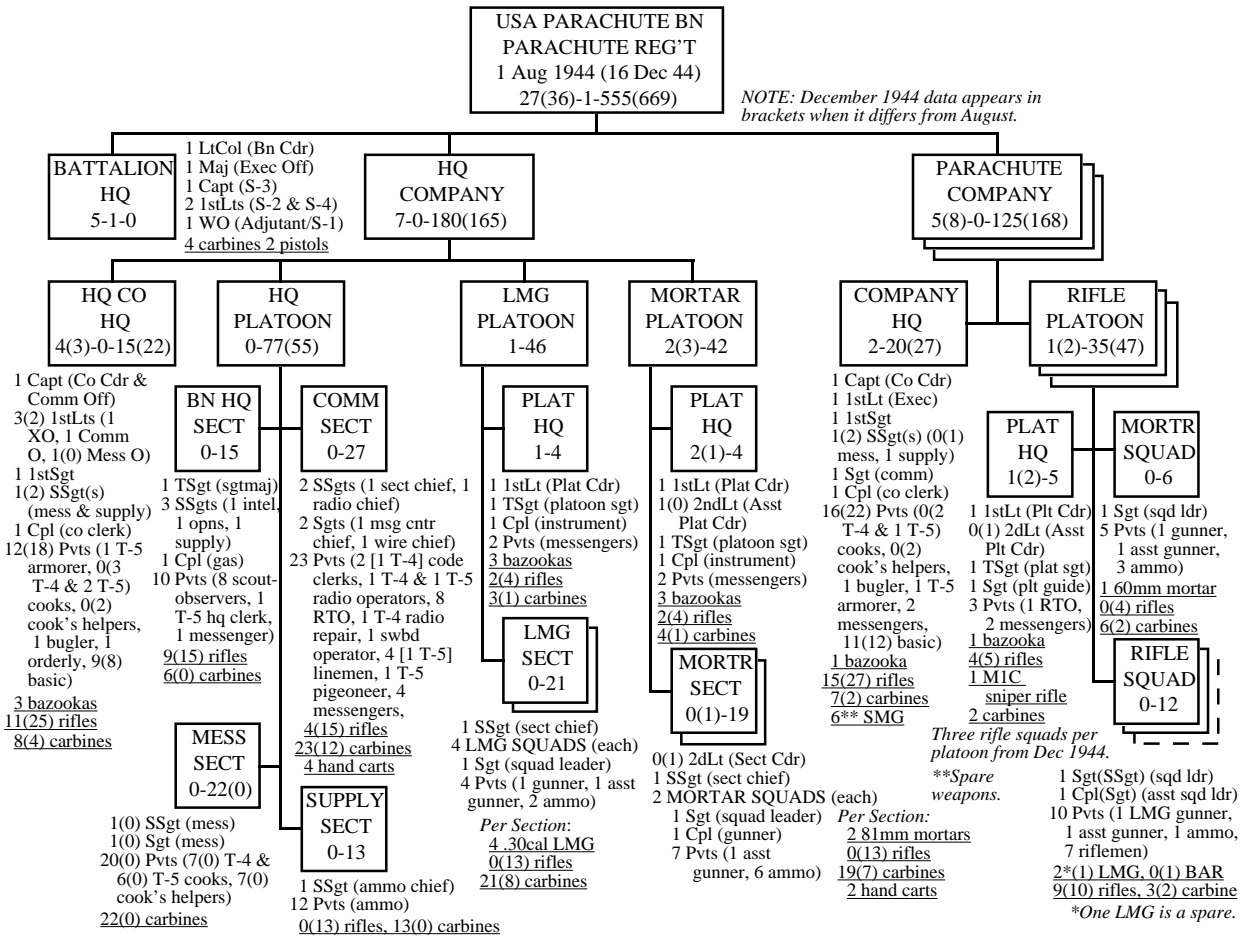

**Notes:**

**Principal Differences Between the August and December 1944 Tables:** (1) Addition of a third rifle squad and an assistant platoon leader (2<sup>nd</sup> lieutenant) to each rifle platoon; (2) battalion mess section replaced by company mess details; and (3) replacement of more than half the carbines in the August 1944 battalion with M1 rifles.

**Small Arms Distribution:** In August 1944 all basic privates, orderlies, buglers, messengers, scout-observers, RTO's (radio telephone operators) not in the communication section, riflemen, rifle squad leaders and assistant squad leaders carry rifles. All others (except the major and lieutenant colonel, who carry pistols) carry carbines. After December 1944 all carbine holders switch to rifles except officers, warrant officers, the headquarters company first sergeant, all mortar and LMG gunners and assistant gunners, 81mm mortar squad leaders, radio operators, the radio repairman, the switchboard operator, and the RTO's in the communication section o retain their carbines.

**Additional Duties:** One T-4 cook runs the battalion officer's mess. The assistant squad leader in each rifle squad is also a demolition NCO.

**Enlisted Ranks:** Under the August 1944 tables the private soldiers in the headquarters company included 21 with technician ratings (13 after December 1944) and 88 PFC (84 after December 1944). In each rifle company as of August 1944 only one private soldier carried a technician rating (four did so after December) but there were 84 PFC (96 after December 1944).

**Source:** War Department Tables of Organization 7-35 and 7-35T "Infantry Battalion, Parachute" 7-36 and 7-36T "Headquarters and Headquarters Company, Infantry Battalion Parachute" and 7-37 and 7-37T "Infantry Rifle Company, Parachute" (Washington DC 1 August 1944 for Tables 7-35, 7-36 and 7-37; and 16 December 1944 for Tables 7-35T, 7-36T and 7-37T).

Appendix 6.16

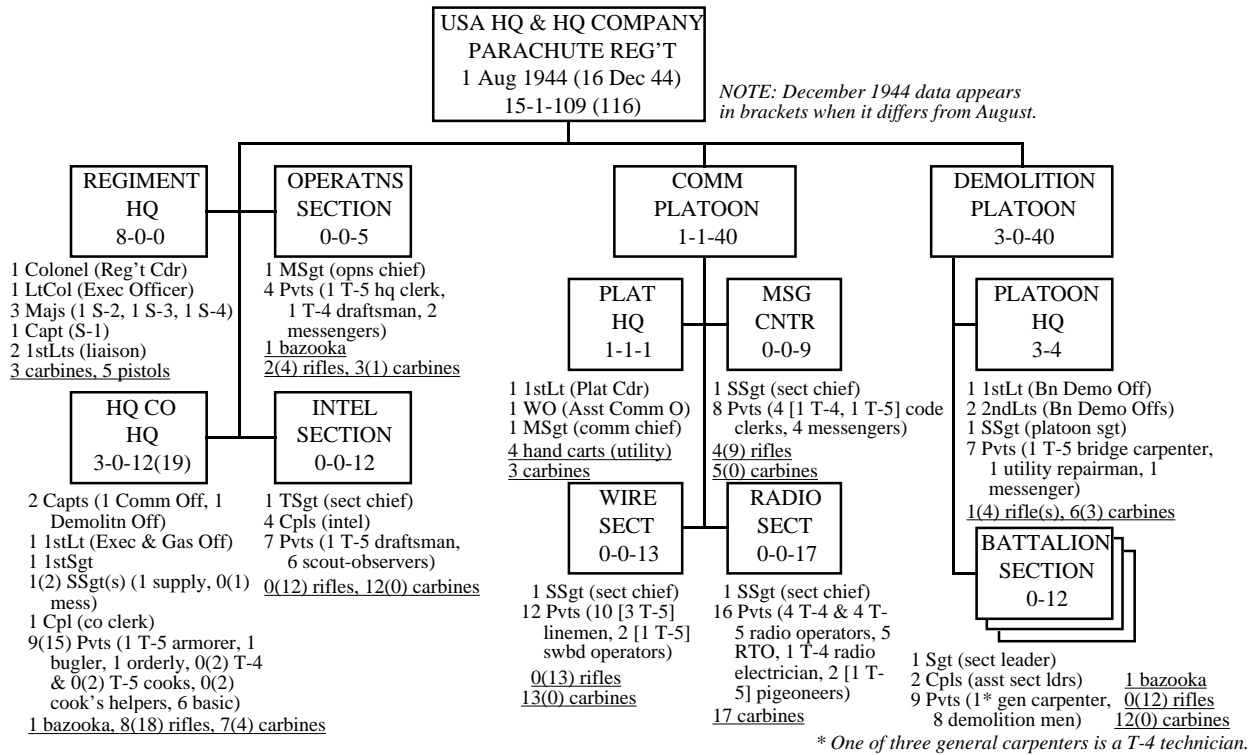

Notes: After December 1944 one T-4 cook runs a regimental officers' mess.

**Small Arms Distribution:** Under August 1944 field grade officers (majors, lieutenant colonel and colonel) carry pistols. Basic privates, messengers, the orderly, and the bugler carry rifles. All others carry carbines. After December 1944, officers, warrant officers, the first sergeant, the master sergeants and all members of the radio section, communication platoon retained their carbines. All others who had previously been armed with carbines switched to rifles.

**Enlisted Ranks:** The private soldiers in the headquarters include 22 with technician ratings (26 after December 1944) and 29 PFC (30 after December 1944).

**Source:** War Department Tables of Organization 7-32 and 7-32T "Headquarters and Headquarters Company, Infantry Regiment, Parachute" (Washington DC 1 August 1944 (7-32) and 16 December 1944 (7-32T)).

Appendix 6.17

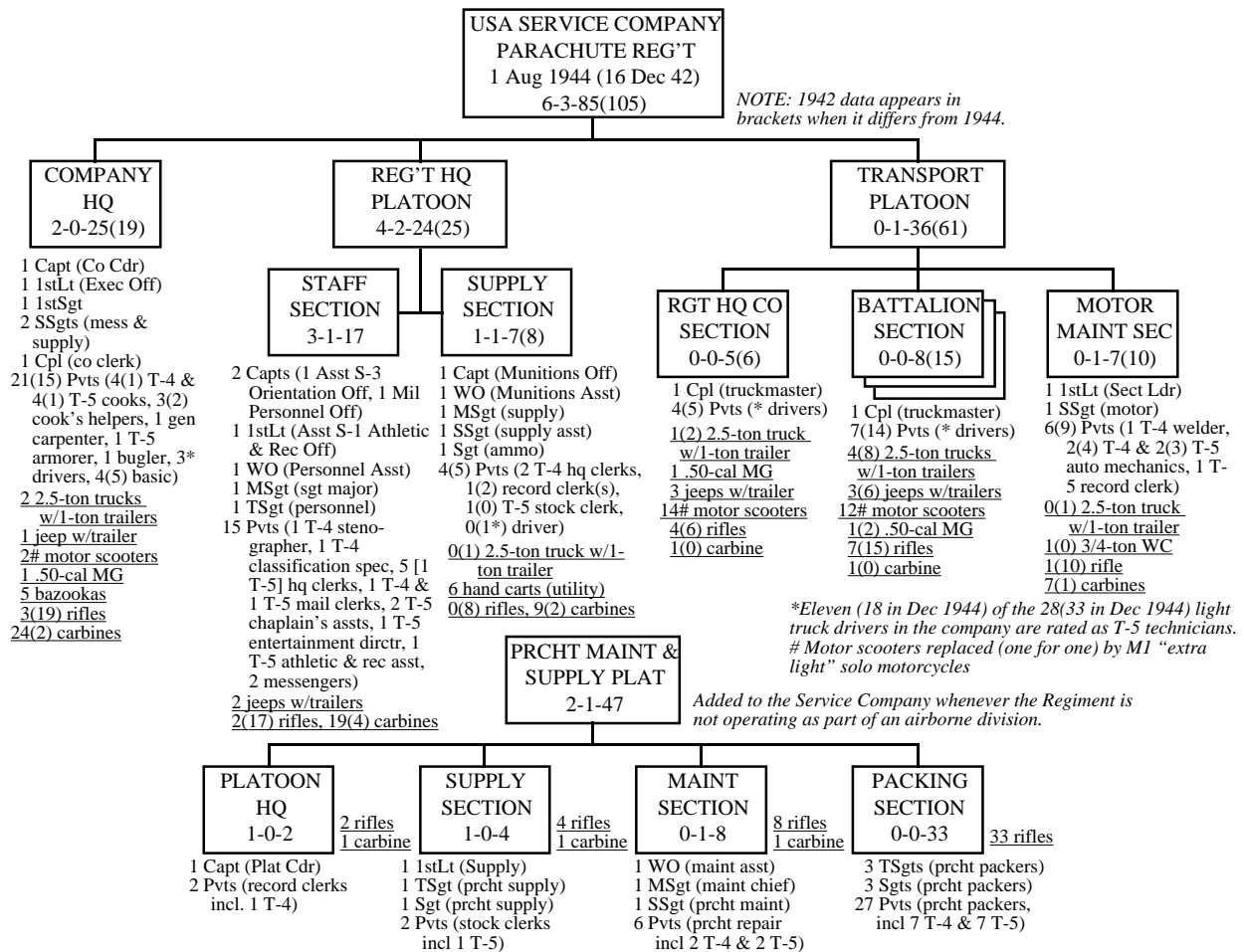

Notes:

Principal Differences Between the August and December 1944 Tables: (1) Mess detail feeds both the headquarters company and the service company is reduced to a smaller detail feeding the service company only; (2) Transportation platoon enlarged in December 1944 to support a larger regiment but it no longer includes any relief drivers; and (3) More than half the carbines in the company replaced by rifles.

Small Arms Distribution: Under the August 1944 tables all truck drivers, the chaplain's assistants (who also drive the staff section's jeeps), the T-5 mechanic driving the motor maintenance section's 3/4-ton truck carry rifles. All others carry carbines. After December 1944 only officers and warrant officers carry carbines. All others switch to rifles.

Enlisted Ranks: Under the August 1944 tables the private soldiers in the company include 38 with technician ratings (42 after December 1944) and 15 PFC (22 after December 1944).

Source: War Department Tables of Organization 7-33 and 7-33T "Service Company, Infantry Regiment Parachute" (Washington DC August 1944 (7-33) and 16 December 1944 (7-33T)).

Appendix 6.18

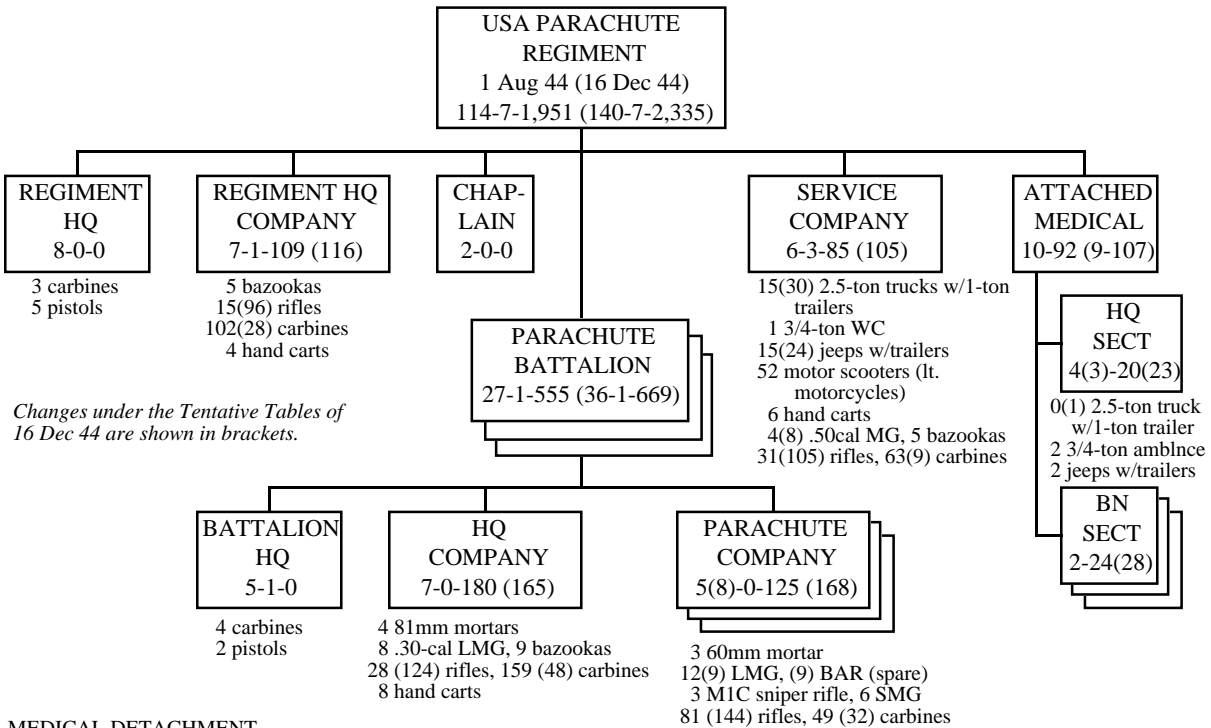

**MEDICAL DETACHMENT**

Headquarters: 1 Maj (Det Cdr), 3(2) Capts or 1stLts (1(0) Medical, 2 Dental), 1 TSgt (medical), 1 Sgt (medical), 18(21) Pvts (2 surgical techs (1), 2 dental techs [T-5 & (2)], 1 medical tech(2), 1 sanitary tech(3), 1 potiatrist [T-4], 1 gen clerk [T-5], 2 amb drivers [1 T-5], 0(1) driver [T-5], 8(10) basic)

3 Battalion Sections (each): 2 Capts or 1stLts (Medical), 1 SSgt (medical), 1 Cpl (medical), 22(26) Pvts (11(15) surgical techs (1), 1 medical tech(2), 10 litter bearers)

Notes: (1) The 35(47) surgical techs in the Detachment include 6(8) T-3, 6(8) T-4 and 12(16) T-5. (2) The four Medical techs in the Detachment include 1 T-4 and 1 T-5. (3) The sanitary tech and one dental tech also drive jeeps.

Notes: Each battalion medical detachment includes six (10 after December 1944) company medics (surgical techs).

Source: War Department Tables of Organization 7-31 and 7-31T "Infantry Regiment Parachute" (Washington DC August 1944 (7-31) and 16 December 1944 (7-31T)).

Appendix 6.19

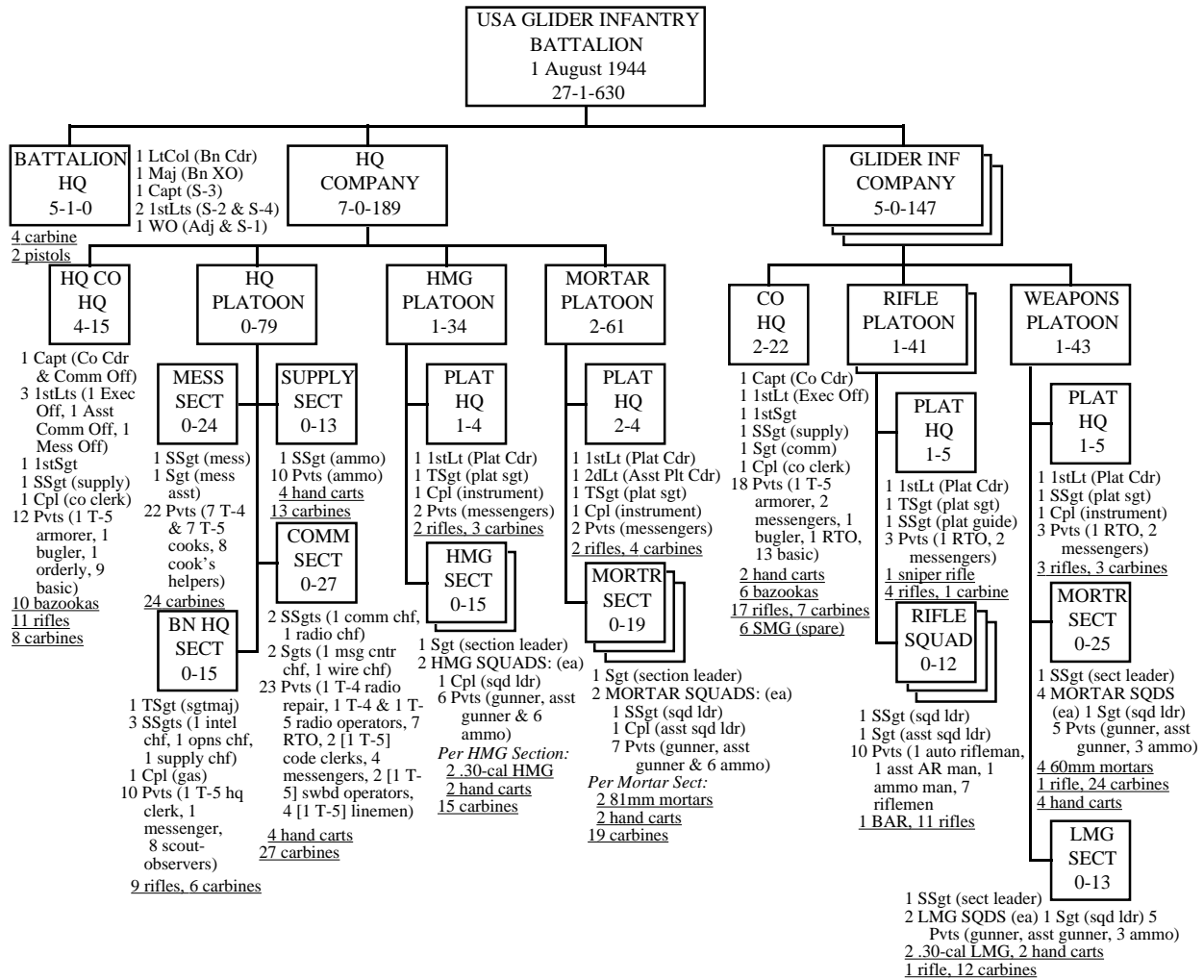

Notes:

**Small Arms Distribution:** In the headquarters and headquarters company all messengers, basic privates, scout-observers, the bugler and the orderly all carry rifles. All others carry carbines except for the lieutenant colonel and major who carry pistols. In the rifle companies basic privates, messengers, RTO (radio telephone operators), all rifle squad members (except BAR men), rifle platoon sergeants and platoon guides, and LMG and mortar section leaders carried rifles. All others carried carbines.

**Enlisted Ranks:** The private soldiers in the headquarters company included 22 with technician ratings and 93 PFC. In each rifle company only one private soldier carried a technician rating (the T-5 armorer) but there were 84 PFC.

**Mess Section:** The battalion has a consolidated mess section that feeds all headquarters and rifle company personnel. One T-4 cook runs the battalion officer's mess.

**Source:** War Department Tables of Organization 7-56 "Headquarters and Headquarters Company, Infantry Battalion, Glider;" 7-57 "Infantry Rifle Company, Glider" (all Washington DC 1 August 1944).

## Appendix 6.20

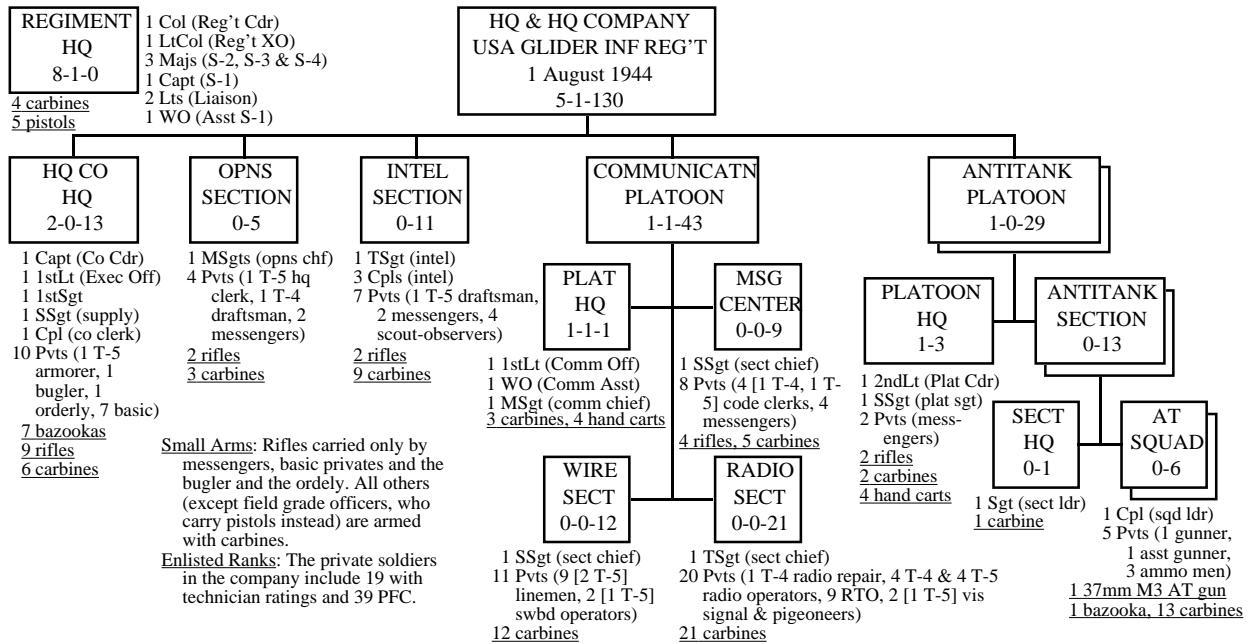

Notes:

Source: War Department Table of Organization 7-52 "Headquarters and Headquarters Company, Infantry Regiment, Glider" (Washington DC 1 August 1944).

## Appendix 6.21

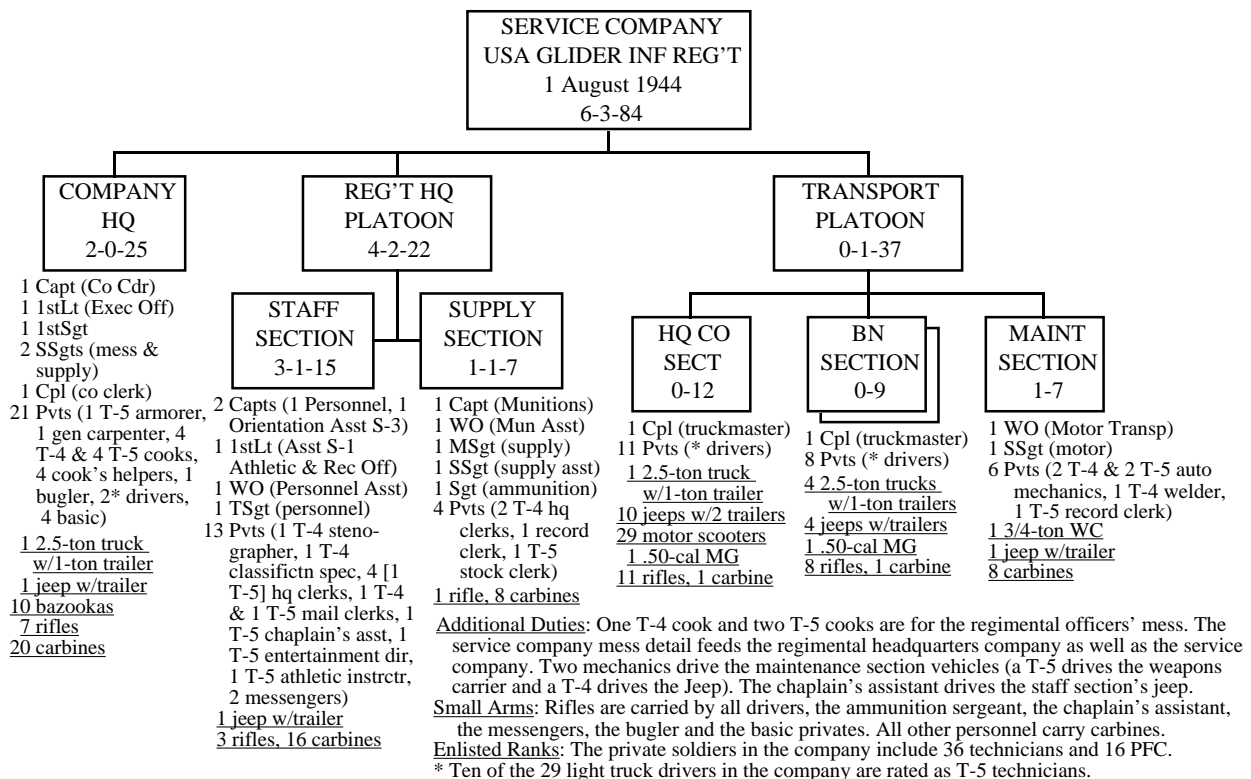

Notes:

Source: War Department Table of Organization 7-53 "Service Company, Infantry Regiment, Glider" (Washington DC 1 August 1944).

Appendix 6.22

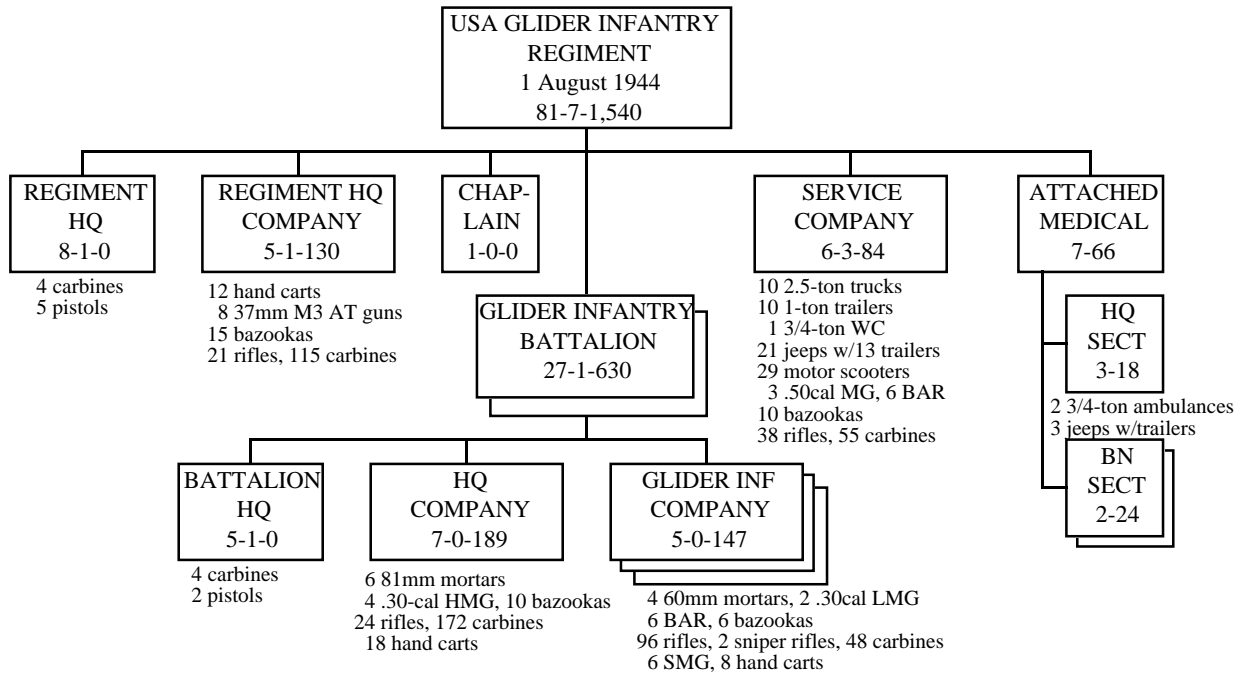

MEDICAL DETACHMENT

Headquarters: 1 Maj (Det Cdr), 2 Cpts or 1stLts (1 Medical, 1 Dental), 1 TSgt (medical), 1 Sgt (medical), 16 Pvts (3 surgical techs (1), 1 podiatrist [T-4], 1 dental tech [T-5], 1 medical tech (2), 1 sanitary tech (3), 1 gen clerk (3), 2 ambulance drivers [1 T-5], 6 basic)

2 Battalion Sections (each): 2 Cpts or 1stLts (Medical), 1 SSgt (medical), 1 Cpl (medical), 22 Pvts (9 surgical techs (1), 1 medical tech (2), 12 litter bearers, 2 basic)

Notes: (1) The 21 surgical techs in the Detachment include 4 T-3, 3 T-4 and 7 T-5. (2) The four medical techs in the Detachment include 1 T-4 and two T-5. (3) The clerk, the dental tech and the sanitary tech also drive jeeps.

Notes: Each battalion medical section includes six company medics (or surgical techs) – enough for one per rifle platoon.

Source: War Department Table of Organization 7-51 “Infantry Regiment, Glider” (Washington DC 1 August 1944).



### Appendix 6.23

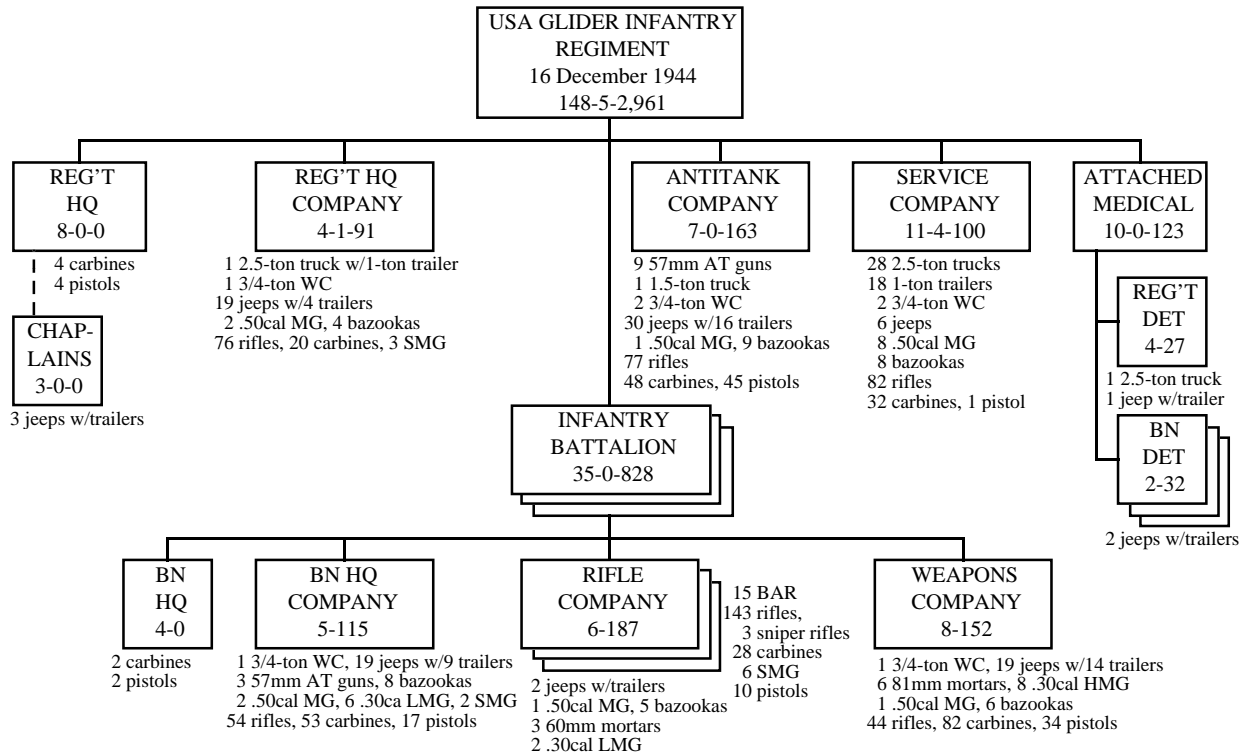

Notes: This regiment resembles the standard US Army Infantry Regiment, T/O&E 7-11 of 24 February 1944 with changes through December. Some differences exist but they are mostly minor and all are listed below.

**Rifle and Weapons Companies:** These are the same as T/O&E 7-17 and 7-18, respectively, (see Appendix 5.10 and 5.11).

**Battalion Headquarters Company:** The same as T/O&E 7-16 (Appendix 5.12) except for minor changes in the pioneer and antitank (or defense) platoons. The pioneer platoon exchanged its 1.5-ton truck and trailer for four jeeps with trailers, one jeep being driven by the driver in platoon headquarters and one member of each pioneer squad driving the other three (as an additional duty). In the antitank platoon the platoon headquarters lost its .50-caliber machinegun and each squad exchanged its 1.5-ton truck for two jeeps, one jeep trailer, one additional driver (increasing the strength of each squad to 11 men) and one rifle. The platoon could substitute M3 37mm antitank guns for its M1 57mm, especially if the latter proved too heavy for an air landing

**Antitank Company:** This was the same as T/O&E 7-19 (Appendix 5.13) except that the three antitank platoons were the same as the battalion antitank platoons. The antitank mine platoon lost the two 2.5-ton trucks with trailers and their two drivers but each antitank mine squad received two jeeps with trailers plus one driver (armed with a rifle). One of the squad members drove the second jeep as an additional duty. In company headquarters the transportation NCO was a staff sergeant rather than a sergeant and there was a second auto mechanic (rated T-5).

**Cannon Company:** No cannon company in this regiment.

**Regimental Headquarters Company:** The same as T/O&E 7-12 (Appendix 5.15).

**Regimental Service Company:** The same as T/O&E 7-13 (Appendix 5.16) except there is no cannon company section and the maintenance section has a staff sergeant chief mechanic (with carbine) and four additional auto mechanics (three T-4 and one T-5, all armed with rifles) but no additional vehicles. In the company headquarters only one auto mechanic rather is rated T-4 and the other two are rated T-5. In addition the corporal (company clerk) carries a carbine rather than a rifle.

**Attached Medical:** The same as T/O&E 7-11 (Appendix 5.17).

**Sources:** War Department Tables of Organization 7-51T "Infantry Regiment, Glider," 7-52T "Headquarters and Headquarters Company, Infantry Regiment, Glider," 7-53T "Service Company, Infantry Regiment, Glider," 7-59T "Antitank Company, Infantry Regiment, Glider," 7-56T "Headquarters and Headquarters Company, Infantry Battalion, Glider," 7-57T "Infantry Rifle Company, Glider" and 7-58T "Infantry Heavy Weapons Company, Glider" (all Washington DC 16 December 1944).

Appendix 6.24

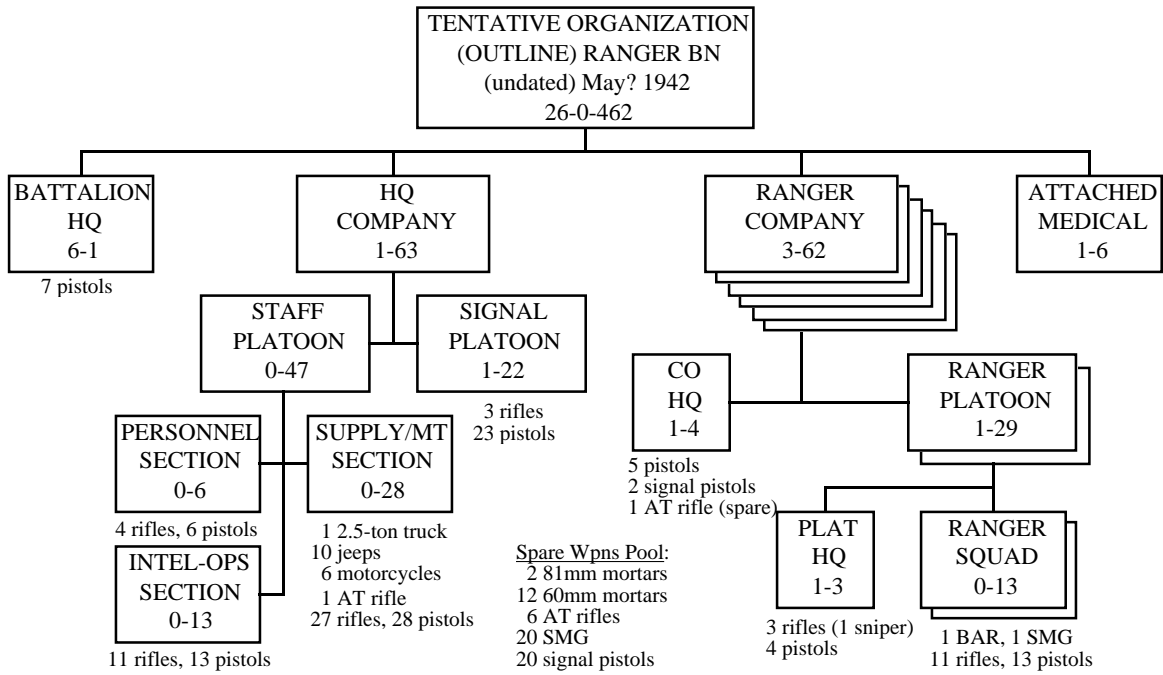

Notes:

Source: 1st Ranger Battalion Journals and Files, organizational charts (undated but probably referring to May 1942) Record Group 407, Entry 427, INBN-1-0, US National Archives Washington DC.

Appendix 6.25

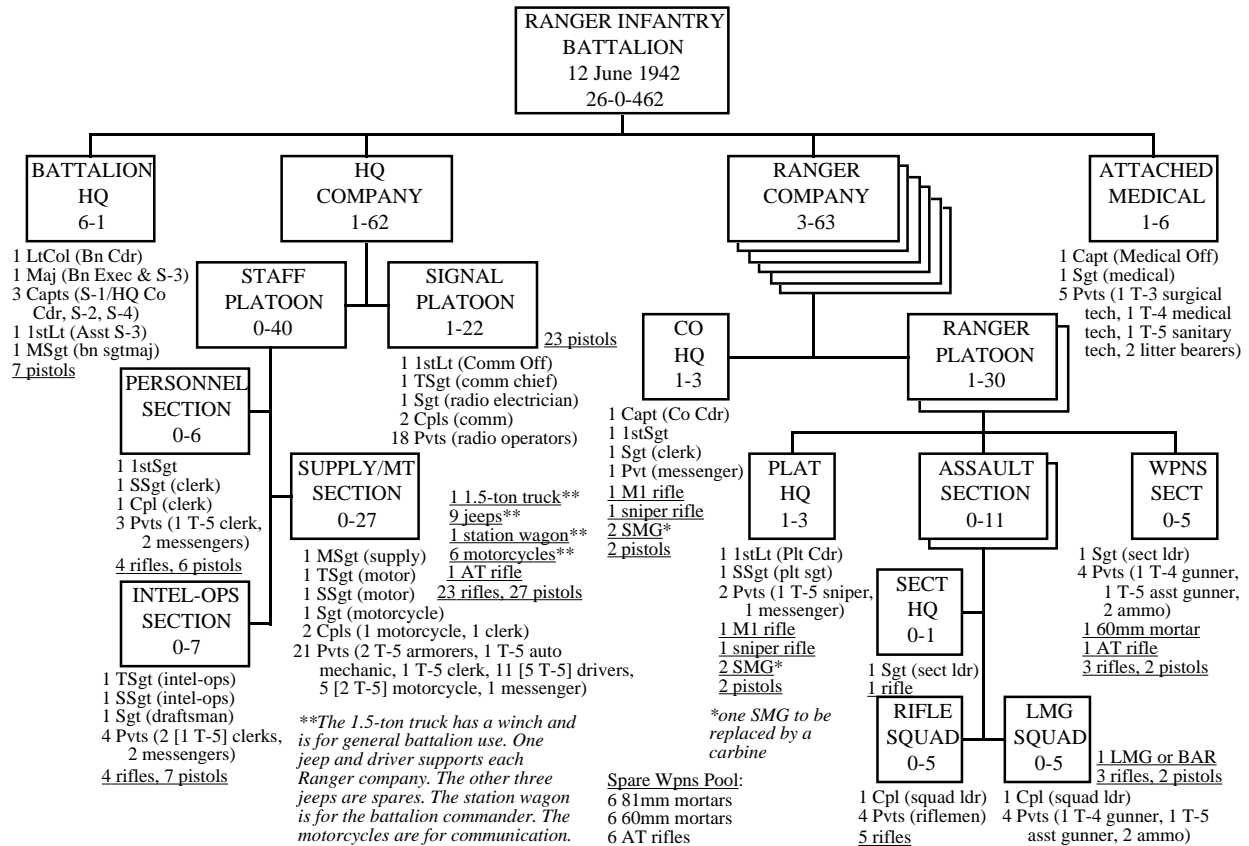

Notes:

**Small Arms Distribution:** Sub-machineguns and pistols were issued to Ranger company officers, first sergeants and platoon sergeants. Sniper rifles were issued to snipers and the messenger in each company headquarters since he was also a sniper. No carbines were available at this time so all other Ranger company personnel carried rifles except LMG and mortar gunners and assistant gunners who carried pistols. In the battalion headquarters and headquarters company all personnel carry pistols and all corporals and privates in the staff platoon also carry rifles.

**Enlisted Ranks:** Twenty-five of the privates in the headquarters company and medical detachment had technician ratings as did 14 privates in each Ranger Company. The tables did not give any total of how many PFC were authorized.

**Medical Detachment:** It was able to operate an aid station only. It could not attach medics to any of the companies.

**Source:** 1st Ranger Battalion Journals and Files, organizational charts (undated but referring to 12 June 1942) Record Group 407, Entry 427, INBN-1-0, US National Archives Washington DC.

**Appendix 6.26**

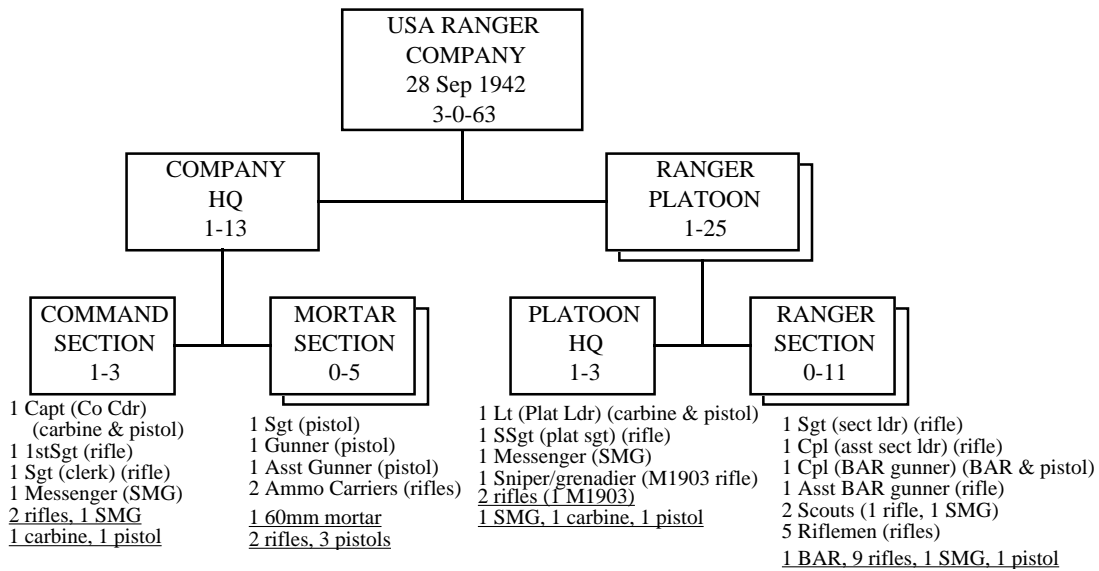

**Notes:**

**Ammunition and Ordnance:** The total weight per company was 1,952 pounds. Company commanders and platoon leaders only were to carry a carbine (with six loaded clips or 90 rounds each) and a pistol with three clips (21 rounds). A sub-machinegun would serve if no carbines were available. Each man armed with a sub-machinegun carried 11 magazines (220 rounds). Each rifleman (with an M1 rifle) was to carry 22 clips (176 rounds) in an ammunition belt and on two bandoliers. For an M1903 rifle a sniper or grenadier would carry 100 rounds in an ammunition belt and eight rifle grenades. All Ranger section members except the automatic rifleman and his assistant carried six fragmentation hand grenades apiece in addition to either a rifle or sub-machinegun (with 176 and 220 rounds each, respectively). An automatic rifleman would carry a BAR with 11 magazines (220 rounds) and a pistol (21 rounds). His assistant would carry an M1 rifle with two bandoleers (12 clips or 96 rounds) for his own weapon and 12 magazines (240 rounds) for the BAR. For each 60mm mortar, the section sergeant, gunner and assistant gunner would together carry the mortar (with accessories and a pair of field glasses), one pistol apiece (with 21 rounds) and 24 60mm rounds. The two ammunition bearers per mortar would carry a rifle (with a full 176 rounds of ammunition) and 12 60mm rounds. In addition, the riflemen in each platoon would also have to carry two eight-foot 24-pound bangalore torpedoes and 17 extra bandoleers (816 rounds) of .30-06 ammunition. Company headquarters would also carry six extra bandoleers (288 rounds). Extra 60mm mortar shells would be carried also.

Weights of Ammunition and Ordnance Per Ranger Company			
AMMUNITION			
TYPE	WEIGHT PER ROUND	TOTAL CARRIED	TOTAL WEIGHT
Caliber .30 M2 (.30-06)	.07 pounds	9,464	640 pounds
Caliber .30 Carbine	.03 pounds	270	7 pounds
Caliber .45 ACP	.045 pounds	1,813	82 pounds
60mm HE M49A1	2.96 pounds	72	216 pounds
Antitank Grenade M9A1	1.31 pounds	16	21 pounds
M2 Frag. Hand Grenade	1.25 pounds	216	270 pounds
Total weight of ammunition = 1,236 pounds			
ORDNANCE			
TYPE	WEIGHT PER WEAPON	TOTAL WEAPONS	TOTAL WEIGHT
60mm Mortar M2	42 pounds	2	84 pounds
BAR M1918A2	21 pounds	4	84 pounds
M1 Rifle	9 pounds	44	406 pounds
M1903 Rifle	8 pounds	2	16 pounds
M1 Carbine	5.5 pounds	3	16 pounds
Sub-machinegun (SMG)	11 pounds	7	77 pounds
Pistols	2.5 pounds	13	33 pounds
Total Weight of Ordnance = 716 pounds			

Source: Memorandum from 1st Ranger Battalion dated 28 September 1942, INBN-1-0 US National Archives Washington DC.

## Appendix 6.27

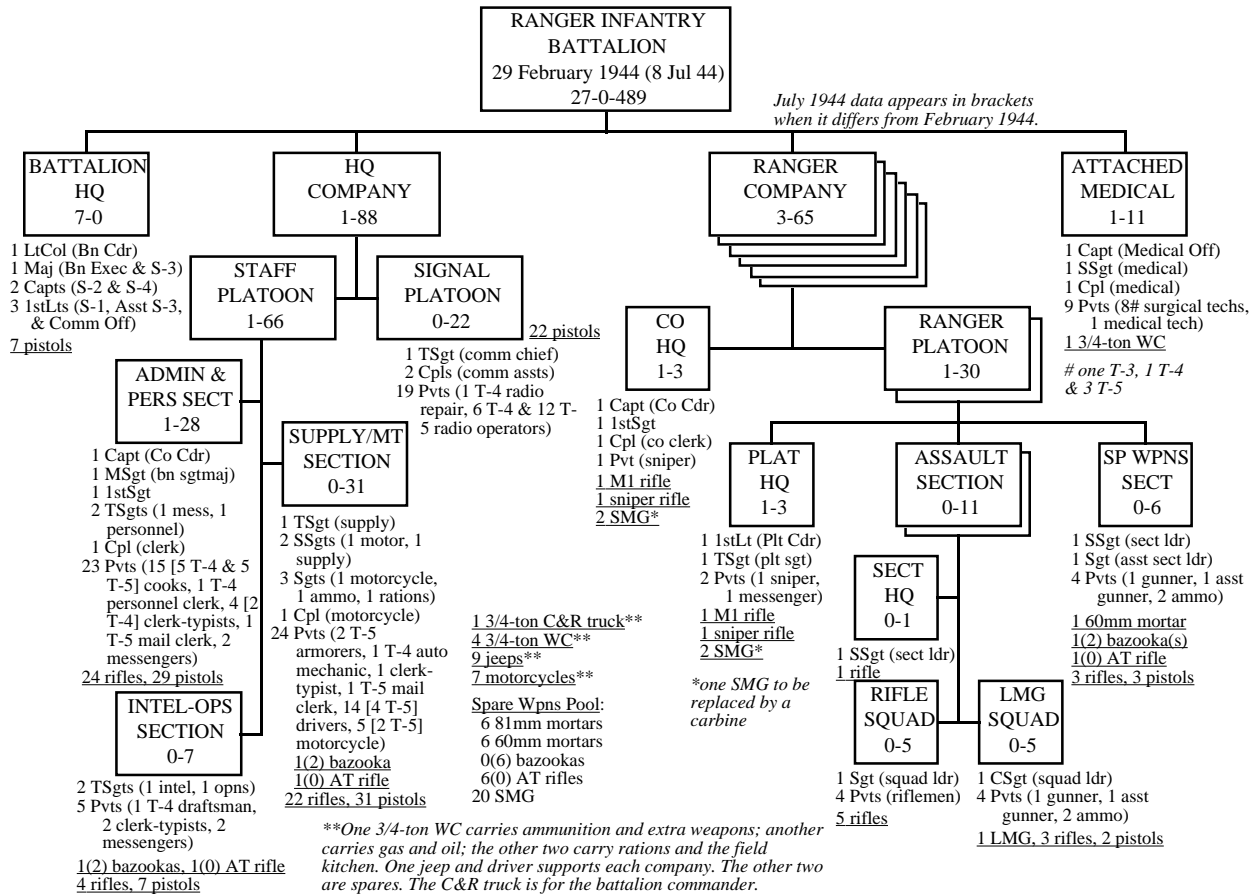

Appendix 6.28

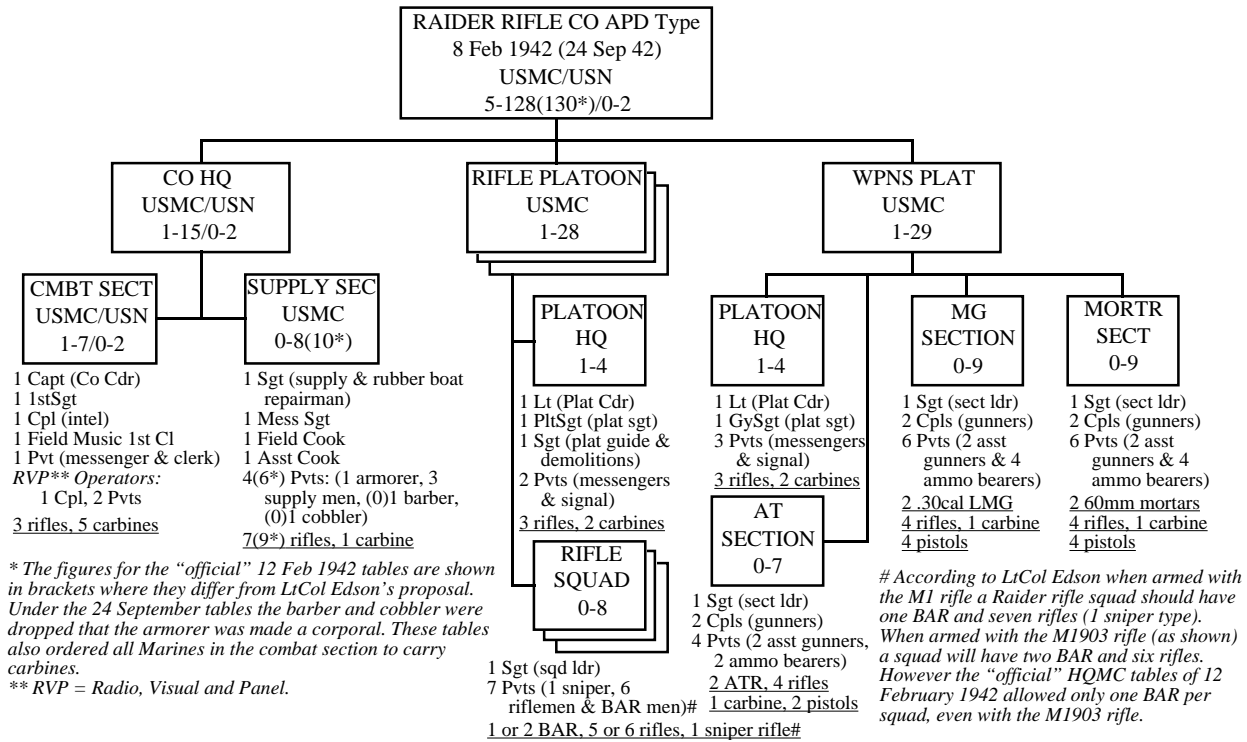

Notes:

**Small Arms Distribution:** The tables required that carbines be issued to officers, the first sergeant, gunnery sergeant, platoon sergeants, the company supply sergeant, mortar, machinegun and antitank section leaders and to the RVP corporal, the messenger and clerk and the field music. However as no carbines were available pistols or in some cases sub-machineguns would serve as substitutes. Lieutenant Colonel Edson had asked that two BAR be issued to each rifle squad for as long as the Raider battalion was substituting M1903 rifles for the M1 but this provision did not appear on the organization tables issued officially by Headquarters Marine Corps.

**Source:** Table APD-1, "Rifle Company, Destroyer (APD) Battalion" attached to a letter from the Commanding Officer, First Separate Battalion to the Commanding General, Amphibious Force, Atlantic Fleet dated 8 February 1942. Updating information obtained from two editions of Marine Corps Table of Organization D-172 "Rifle Company, Marine Raider Battalion" (Washington DC dated 12 February 1942 and 24 September 1942).

Appendix 6.29

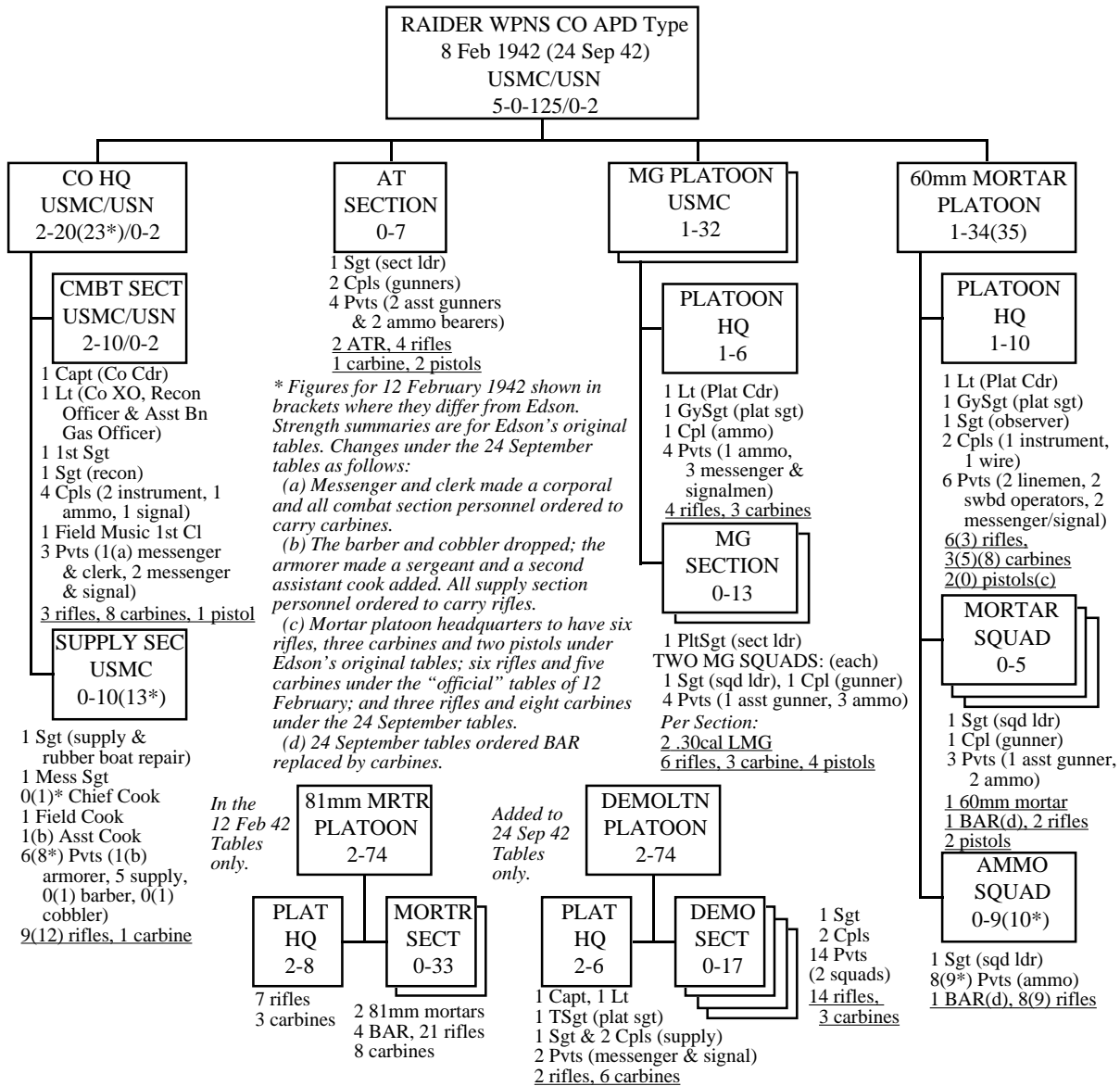

Notes:

**81mm Mortar Platoon:** Same as the standard infantry battalion mortar platoon but without hand carts (see Appendix 5.19).

**Small Arms Distribution (under the APD tables only):** BAR issued to mortar and ammunition squad leaders. Carbines (pistols or sub-machineguns used as substituted) issued to officers, the first sergeant, gunnery sergeants, the supply sergeant, the sergeant observer (60mm platoon), the machinegun section and squad leaders, the ammunition corporals (machinegun platoons), instrument corporals and messengers and signalmen (company headquarters), the antitank section leader, and the field music. Pistols issued to the recon sergeant, telephone linemen, antitank gunners and machinegun and mortar gunners and assistant gunners. All others carry rifles.

**Source:** Tables APD-2, "60mm Mortar Platoon, Weapons Company, Destroyer (APD) Battalion" and APD-3 "Weapons Company, Destroyer (APD) Battalion" attached to a letter from the Commanding Officer, First Separate Battalion to the Commanding General, Amphibious Force, Atlantic Fleet dated 8 February 1942. Updating information obtained from two editions of Marine Corps Tables of Organization D-170 "60mm Mortar Platoon, Weapons Company, Marine Raider Battalion" (Washington DC dated 12 February 1942 and 24 September 1942); D-171 "81mm Mortar Platoon, Weapons Company, Marine Raider Battalion" (Washington DC dated 12 February 1942 only); and D-172 "Weapons Company, Marine Raider Battalion" (Washington DC dated 12 February 1942 and 24 September 1942).

Appendix 6.30

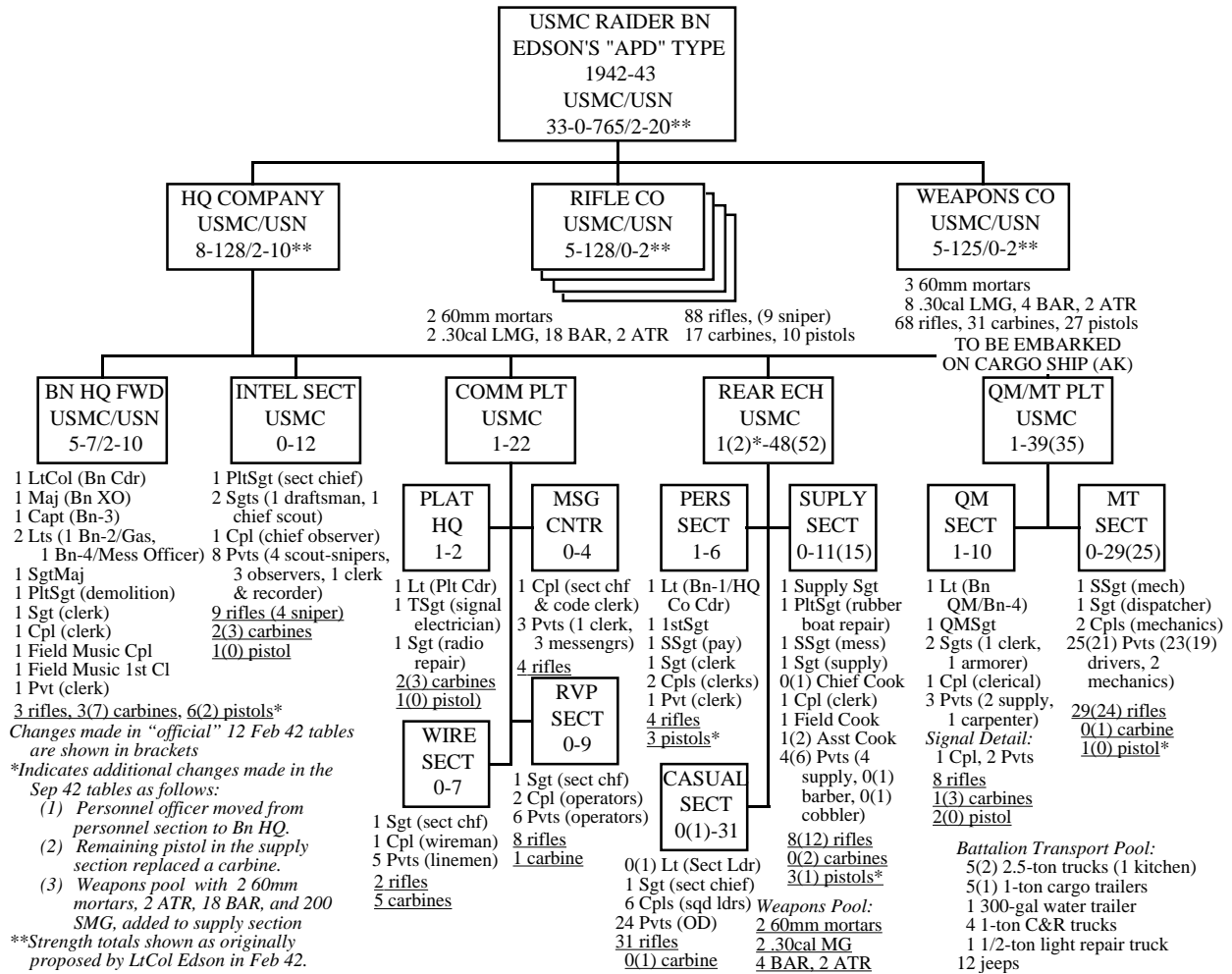

Notes:

**Small Arms Distribution (Edson's APD Battalion only):** Pistols carried by all officers, the sergeant major, the first sergeant, the quartermaster sergeant, supply sergeant, the platoon sergeant (rubber boat repair), all staff sergeants and the sergeant (draftsman). Carbines (but pistols or sub-machineguns had to be substituted for them) were issued to the platoon sergeant (demolition) and the field musics in company headquarters; the section chief, chief scout and chief observer (intelligence section), the technical sergeant, sergeant (radio repair), the wire and RVP section chiefs and linemen (communication platoon); and the signal corporal (quartermaster section). All others carried rifles.

**Source:** Tables APD-4, "Communication Platoon, Headquarters Company, Destroyer (APD) Battalion," APD-5 "Headquarters Company, Destroyer (APD) Battalion" and APD-6 "Destroyer (APD) Battalion" attached to a letter from the Commanding Officer, First Separate Battalion to the Commanding General, Amphibious Force, Atlantic Fleet dated 8 February 1942. Updating information obtained from two editions of Marine Corps Tables of Organization D-173 "Communication Platoon, Headquarters Company, Marine Raider Battalion" (Washington DC dated 12 February 1942) and D-174 "Headquarters Company, Marine Raider Battalion" and D-175 "Marine Raider Battalion" (Washington DC dated 12 February 1942 and 24 September 1942).



Appendix 6.31

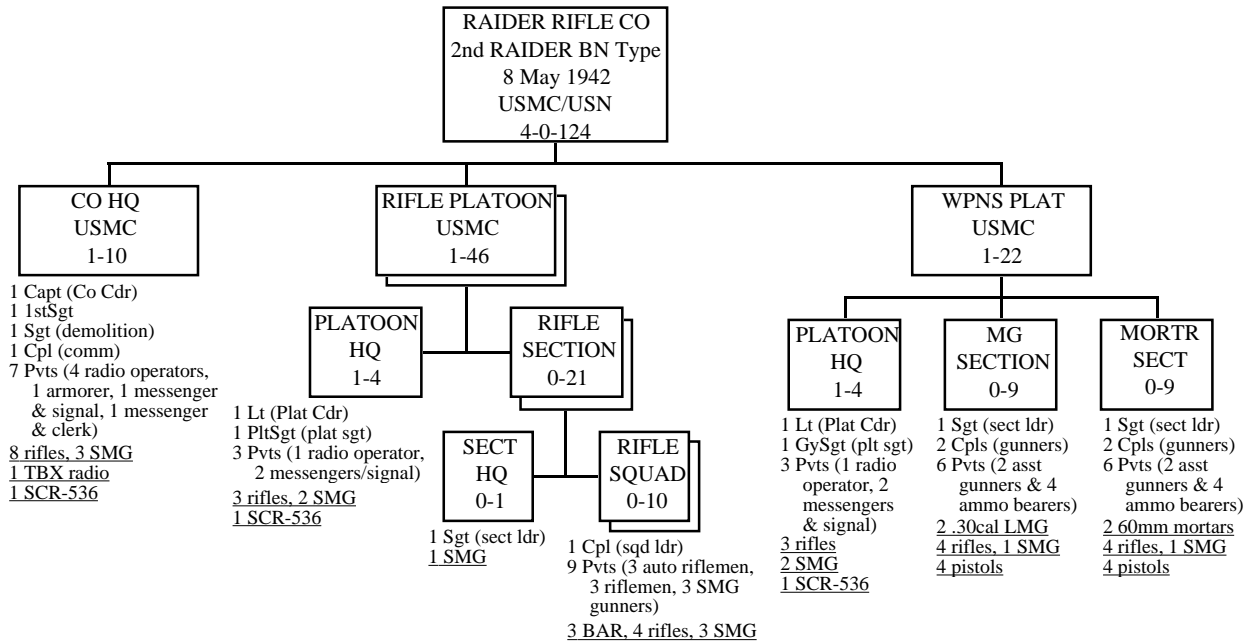

Notes:

Small Arms Allocation: Except in the rifle squads, Marines ranking as sergeants or higher carry Reising sub-machineguns and Marines as corporals or privates carry rifles. Three privates per rifle squad carry automatic rifles (BAR) and three carry either Reising or Thompson sub-machineguns. All other squad members carry rifles.

Source: Letter from Major Samuel B. Griffith II to The Commandant US Marine Corps, subject: Organization of Marine Corps Raider Battalions, dated 7 May 1942 plus attached table (Enclosure B) "Detailed Proposed Table of Organization and Equipment, Rifle Company, Marine Raider Battalion."

Appendix 6.32

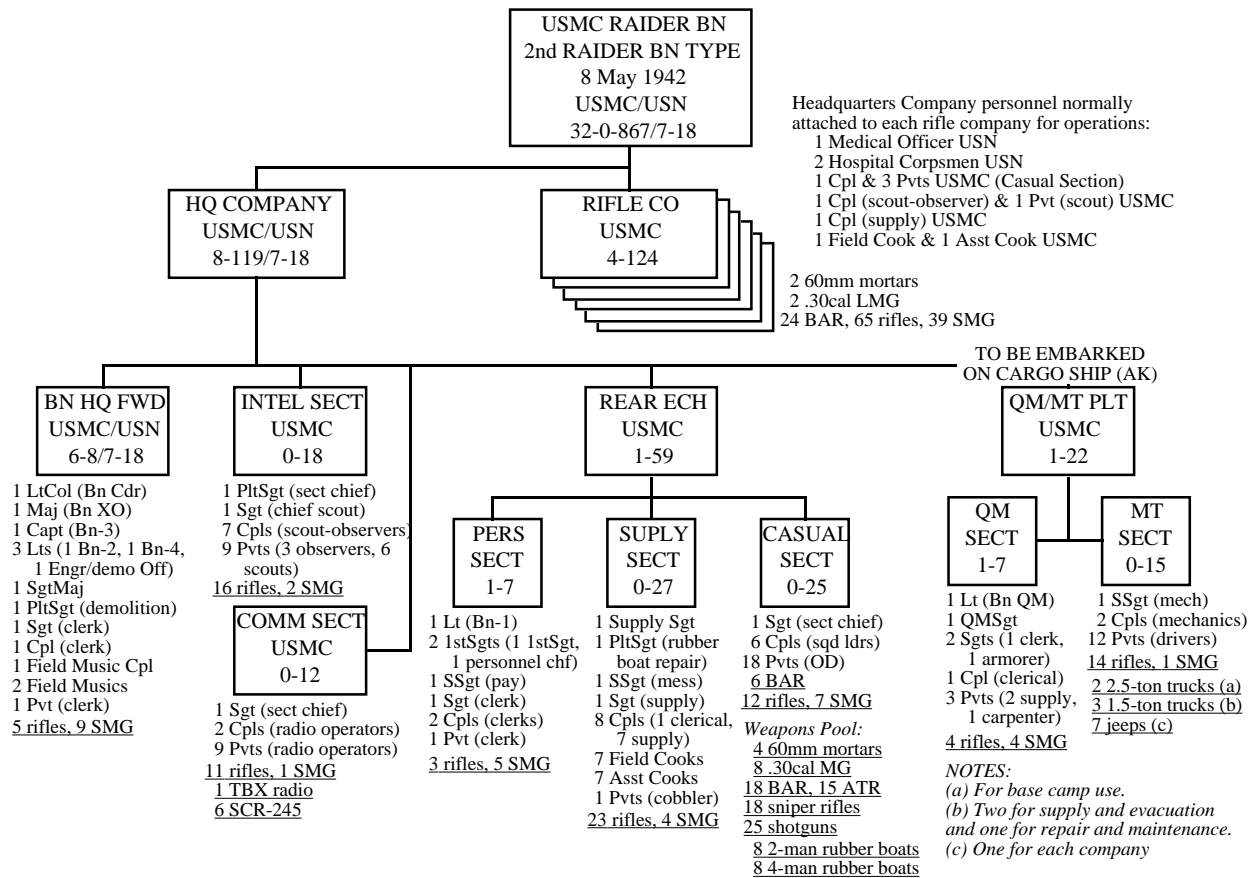

Notes:

**Small Arms Distribution:** Though in Enclosure A to his 7 May 1942 letter Griffith allocates weapons to each section in the headquarters company he does not assign weapons to individuals. However a comparison of personnel with weapons makes it fairly clear that Griffith intended that anyone ranking as a sergeant or higher would carry a sub-machinegun while those ranking as corporals or lower would carry rifles. The one exception is the casual section in which the six corporal squad leaders carried sub-machineguns and six of the privates carried BAR's.

**Source:** Letter from Major Samuel B. Griffith II to The Commandant US Marine Corps, subject: Organization of Marine Corps Raider Battalions, dated 7 May 1942 plus attached table (Enclosure A) "Detailed Proposed Table of Organization and Equipment, Headquarters Company, Raider Battalion."

Appendix 6.33

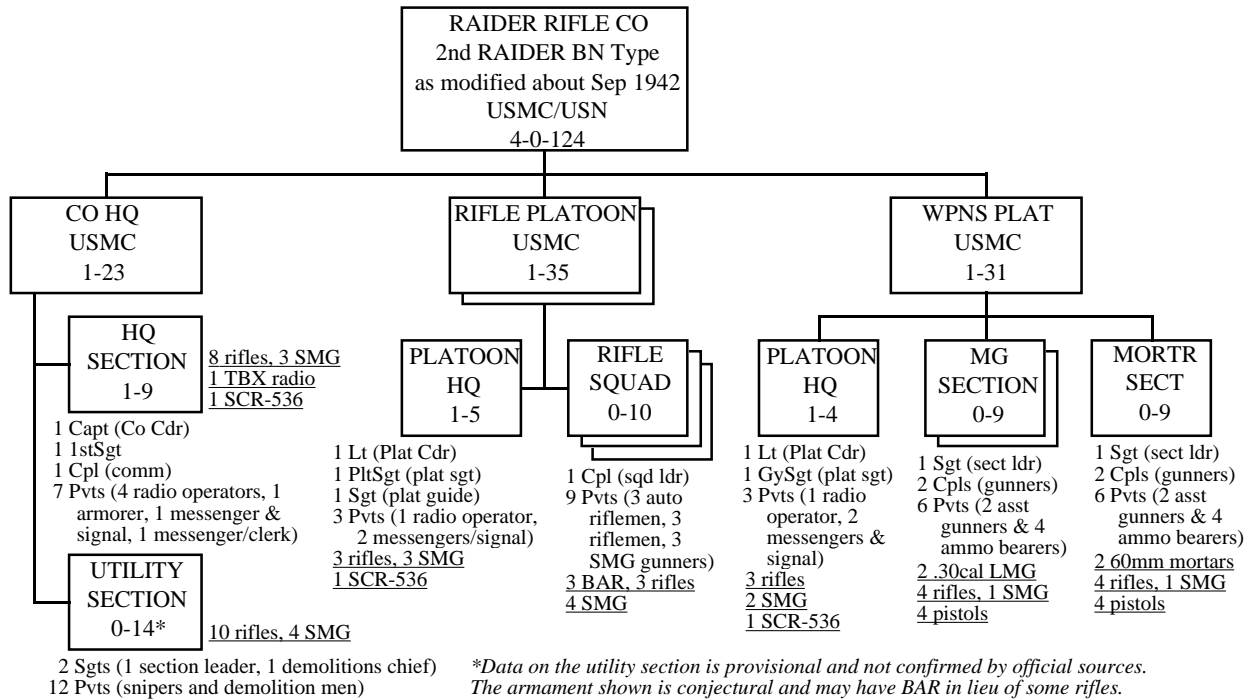

Notes:

**Source:** This writer has been unable to find LtCol Carlson's original September 1942 letter in which he describes the organization of his modified Raider company in September 1942. The above diagram is based mainly on a summary of the Carlson letter that appears in Charles L. Updegraph, *Special Marine Corps Units of World War II* (Washington DC, Headquarters US Marine Corps 1972) pages 21-22 plus baseline data provided by Major Griffith's letter of 7 May 1942 and its enclosures.

Appendix 6.34

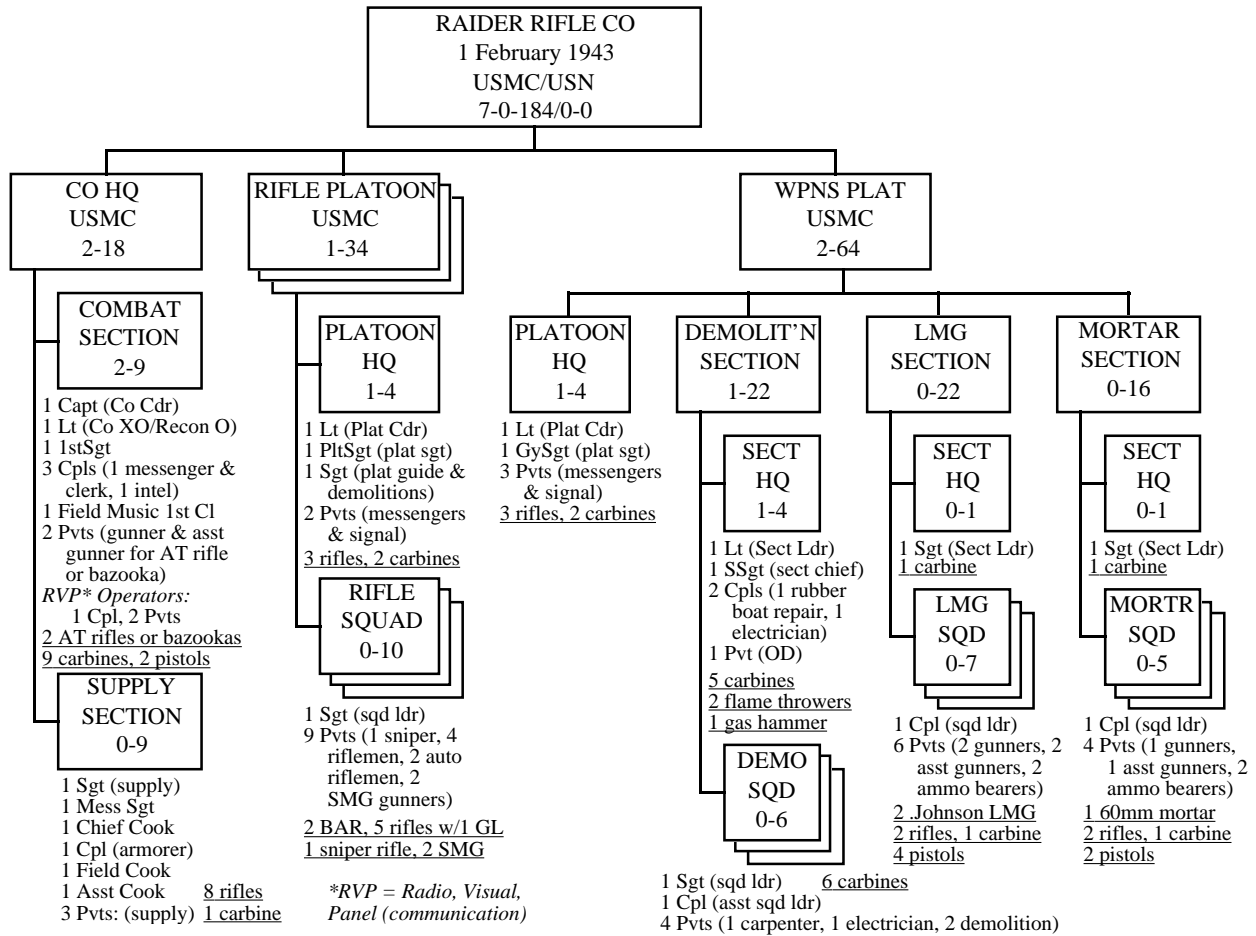

Notes:

**Small Arms Distribution:** Carbines distributed to officers and enlisted men (except rifle squad leaders) ranking as sergeants or higher plus all members (except two antitank gunners) of the combat section of the company headquarters, all members of the demolition section and all LMG and mortar squad leaders. All mortar, LMG and antitank gunners and assistant gunners carry pistols. All other (except rifle squad members) carry rifles.

**Source:** Marine Corps Table of Organization D-306 "Rifle Company, Marine Raider Battalion, Marine Raider Regiment" (HQMC Washington DC 1 February 1943).

Appendix 6.35

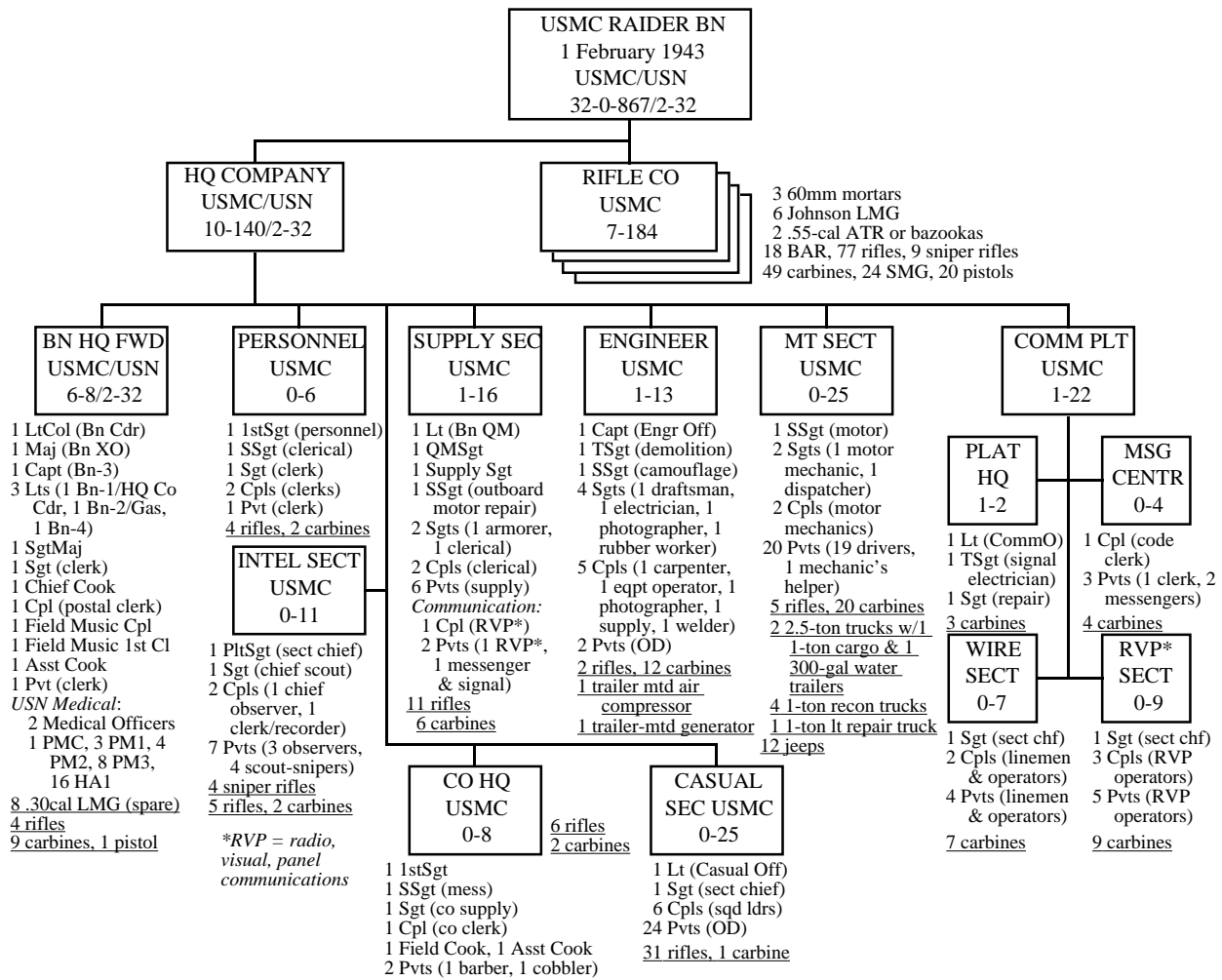

Notes:

**Small Arms Allocation:** Rifles issued to the sergeant (clerk) and private (clerk) in battalion headquarters, all cooks, all intelligence section members except the section chief and chief scout, all clerks in the personnel section ranking below staff sergeant, all supply section personnel ranking below staff sergeant (except the two RVP operators), all company headquarters personnel except the first sergeant and the staff sergeant (mess), all enlisted members of the casual section, the "other duty" privates in the engineer section, and the dispatcher, motor mechanics and mechanic's helper in the motor transport section. All other personnel carry carbines except the battalion commander who carries the only pistol.

**Source:** Marine Corps Tables of Organization D-308 "Marine Raider Battalion, Marine Raider Regiment" and D-307 "Headquarters Company, Marine Raider Battalion, Marine Raider Regiment" (HQMC Washington DC 1 February 1943).

Appendix 6.36

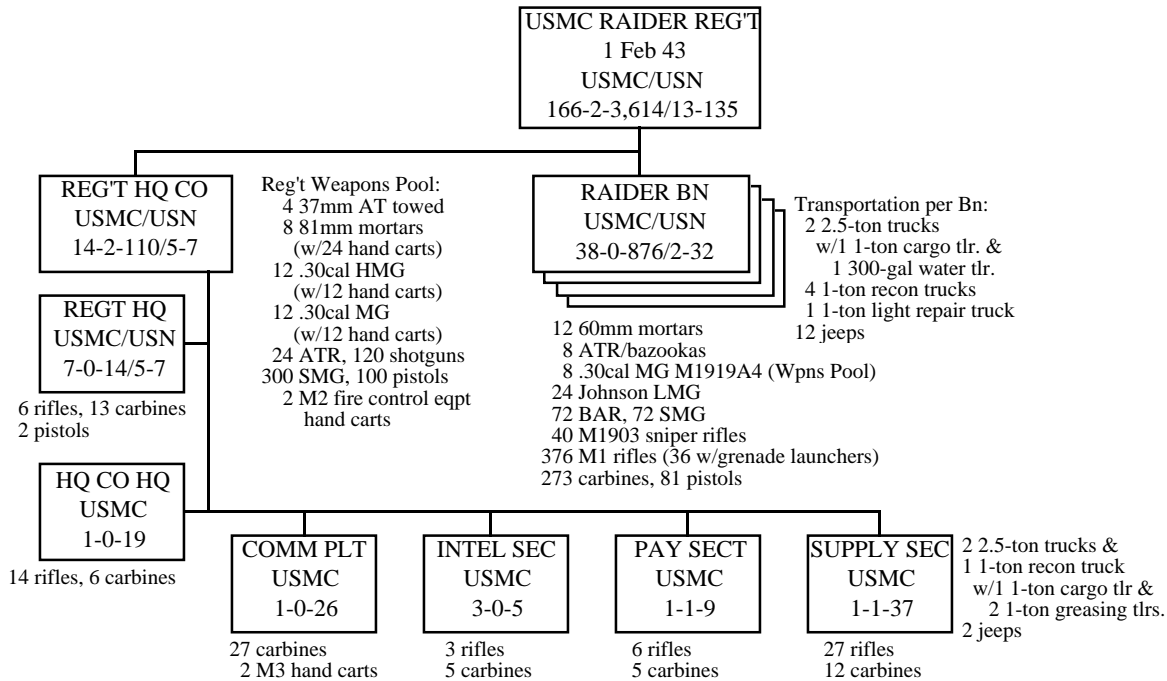

Notes:

**Regimental Headquarters:** 1 Colonel, 1 Lt Colonel, two Majors (R-3 and R-4), one Captain (R-1), two Lieutenants (Assistant R-1 and Assistant R-4 for Munitions), sergeant major, first sergeant (personnel); one staff sergeant, one sergeant, two corporals and two privates (postal clerks); one sergeant, two corporals and two privates (clerks) and one field music corporal.

**Headquarters Company Headquarters:** One Captain (Company Commander), one first sergeant (company), one technical sergeant (mess), one sergeant (supply and property); one chief cook, one field cook and one assistant cook; one field music sergeant, one field music corporal and one field music first class; corporal (company clerk), one barber, one carpenter, one postal clerk, one messenger, one supply man, five "other duty" privates.

**Communication Platoon:** One Captain (communication officer), one technical sergeant (communication chief), one staff sergeant (signal repair); two messengers (privates); one sergeant (radio chief) with eight operators (two corporals and six privates); one sergeant (wire chief) with two wire chiefs (corporals), four switchboard operators (a corporal and three privates) and six linemen (privates).

**Intelligence Section:** One Captain (R-2), two Lieutenants (Liaison), one platoon sergeant (section chief), one staff sergeant (draftsman), one corporal (clerk) and two privates ("other duty").

**Pay Section:** One Captain (Paymaster), one Warrant Officer (Paymaster Clerk), one paymaster sergeant, one technical sergeant (paymaster), one sergeant (clerical), two corporals (clerical) and three privates (clerical).

**Supply Section:** One Lieutenant (Quartermaster Assistant), one Warrant Officer (Quartermaster Clerk), one quartermaster sergeant, two technical sergeants (one motor transport and one rubber boat and outboard motor repair), two staff sergeants (clerical), four sergeants (one armorer, two clerical and one motor mechanic), five corporals (three clerical and two motor mechanics) and 23 privates (two clerks, five drivers, one mechanic's helper, seven supply men and eight "other duty").

**Source:** Marine Corps Tables of Organization D-309 "Headquarters and Service Company, Marine Raider Regiment" and D-310 "Marine Raider Regiment" (HQMC Washington DC 1 February 1943).

Appendix 6.37

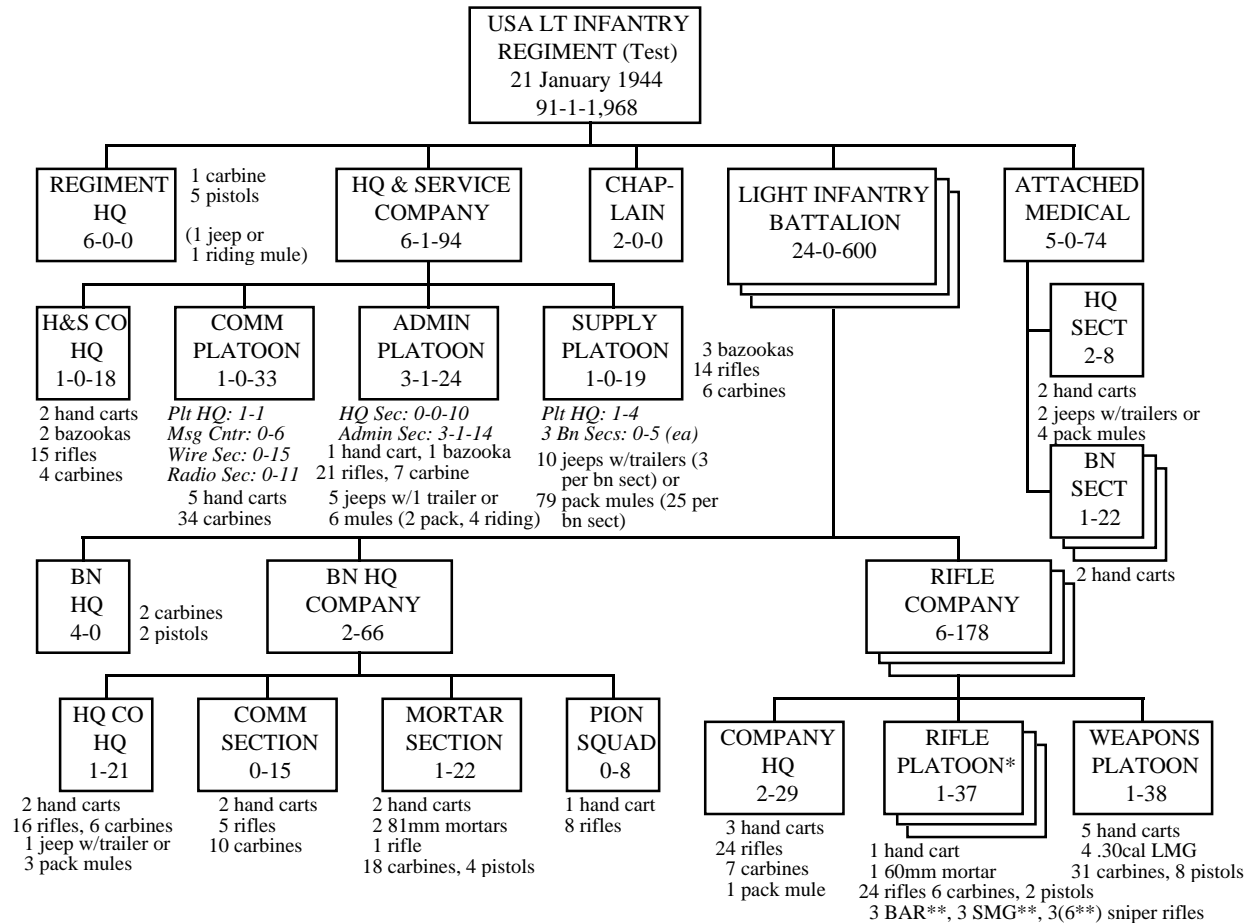

Notes:

- Rifle Platoon:** Lieutenant, one technical sergeant (rifle), two messengers (rifles), three rifle squads (a staff sergeant, a sergeant and seven privates each), and a mortar squad (a sergeant, six privates, a mortar and a hand cart).
- Weapons Platoon:** Lieutenant, one technical sergeant, two LMG sections (each with a staff sergeant and two squads with a sergeant, six men and two hand carts each) and one ammunition squad (a sergeant, eight privates and one hand cart).
- Rifle Company Headquarters:** Captain, one Lieutenant, one first sergeant, two staff sergeants (mess and supply), one corporal (clerk), four cooks (two T-4 and two T-5), two cook's helpers, one armorer (T-5), and 16 basic privates.
- Battalion Headquarters:** Lieutenant Colonel, one Major, one Captain (S-3) and one First Lieutenant (combined S-1 and S-4).
- Battalion HQ Company HQ:** First Lieutenant (S-2 and company commander), one first sergeant, one technical sergeant (battalion sergeant major), three staff sergeants (operations chief, company mess, company supply and clerk), one sergeant (intelligence chief), two cooks (one T-4 and one T-5), one cook's helper, six scout-observers, six basic privates.
- Comm. Section:** Staff sergeant (chief), five radio operators (two T-4 & two T-5), five linemen (one T-5), & four messengers.
- Mortar Section:** Second Lieutenant, staff sergeant (rifle), one lineman and two squads (a sergeant and nine men each).
- Pioneer Squad:** Staff sergeant and seven pioneers.
- Regimental Headquarters:** Colonel, One Lieutenant Colonel, three Majors (S-2, S-3 and S-4), and one Captain (S-1).
- Regimental H&S Company HQ:** Captain (communication officer), first sergeant, two staff sergeants (mess & supply), one corporal (clerk), two cooks (one T-4 & one T-5), one cook's helper, one armorer (T-5), one orderly, and nine basic privates.
- Communication Platoon:** First Lieutenant (assistant communications officer), master sergeant (chief), code clerk (T-5), message center clerk, four messengers, 10 radio operators (three T-4 & three T-5), one radio repair (T-4), two switchboard operators (one T-5) and 13 linemen (one T-5).
- Headquarters Section (Administrative Platoon):** Two master sergeants (sergeant major & operations chief), one sergeant (intelligence chief), one draftsman (T-4) and six scout-observers.
- Administrative Section (Administrative Platoon):** Captain (asst S-3 special services), two First Lieutenants (one personnel officer, one athletic and recreation officer), technical sergeant (personnel), one stenographer (T-4), two headquarters clerks (one T-4 & one T-5), two mail clerks (one T-4 & one T-5), one T-5 athletic instructor, one T-5 chaplain's assistant, one T-5 entertainment director, five clerk-typists, two messengers.
- Regimental Supply Platoon:** First Lieutenant, master sergeant (supply), technical sergeant (senior packer), two supply clerks (one T-4 and one T-5) and three battalion sections (staff sergeant, three cargadors [one T-5] and a clerk each).
- Medical Detachment HQ Section:** Major (Medical), Captain or First Lieutenant (Dental), technical sergeant (medical), sergeant (medical), two surgical techs (one T-4 & one T-5), one dental tech (T-5), one medical tech, one sanitary tech, one sanitary tech and one basic private.
- Battalion Section, Medical Detachment:** Captain or First Lieutenant (Medical), staff sergeant (medical), corporal (medical), eight surgical techs (one T-4 & two T-5, and include two medics per rifle company), two medical techs (one T-5), eight litter bearers and two basic privates.
- Source:** War Department Tables of Organization 7-71T "Light Infantry Regiment," 7-72T "HQ and Service Company, Light Infantry Regiment;" 7-76T "HQ and HQ Company, Light Infantry Battalion;" and 7-77T "Light Infantry Rifle Company" (Washington DC 21 January 1944).

Appendix 6.38

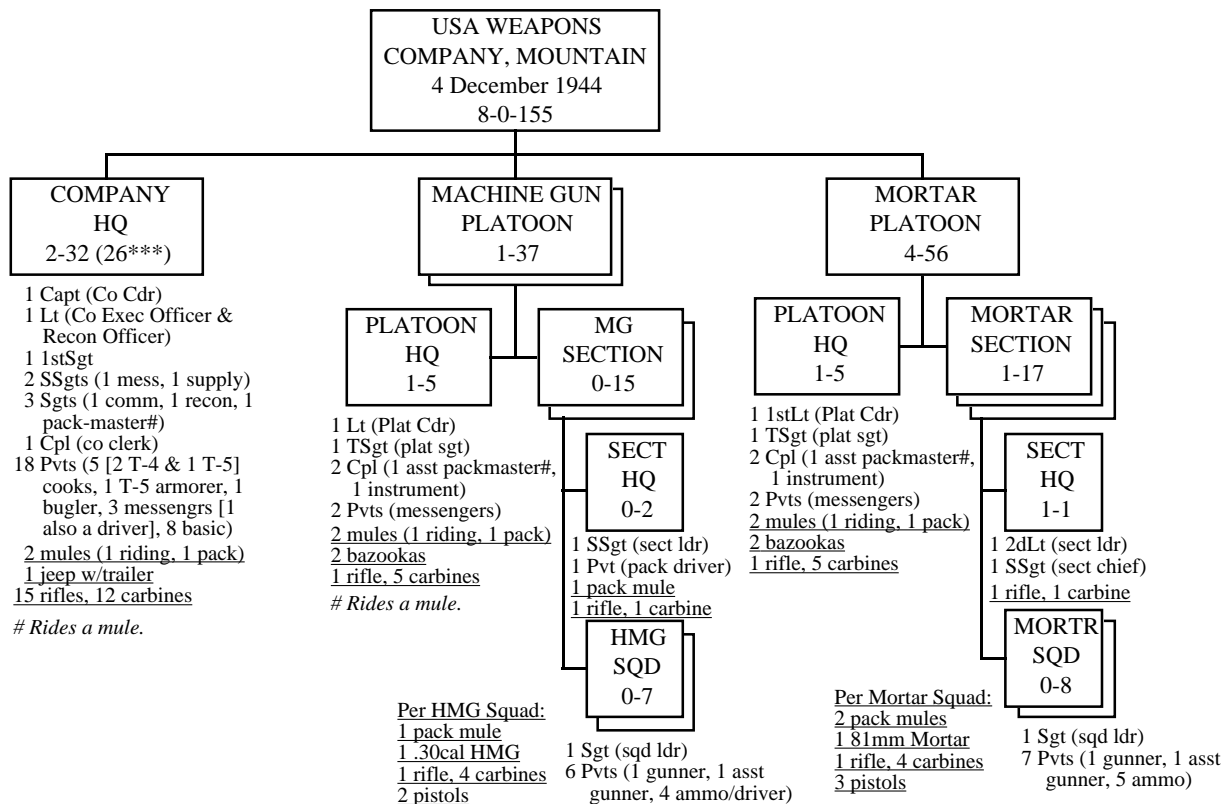
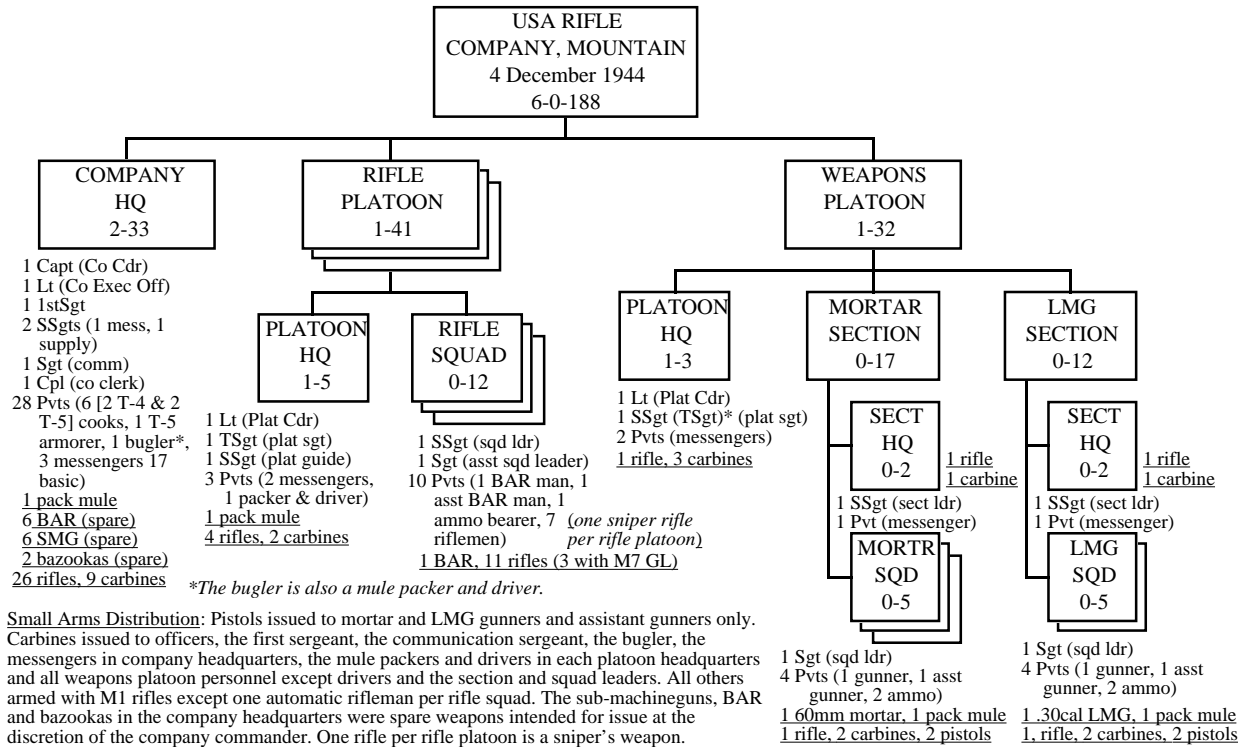



Appendix 6.38 (continued)

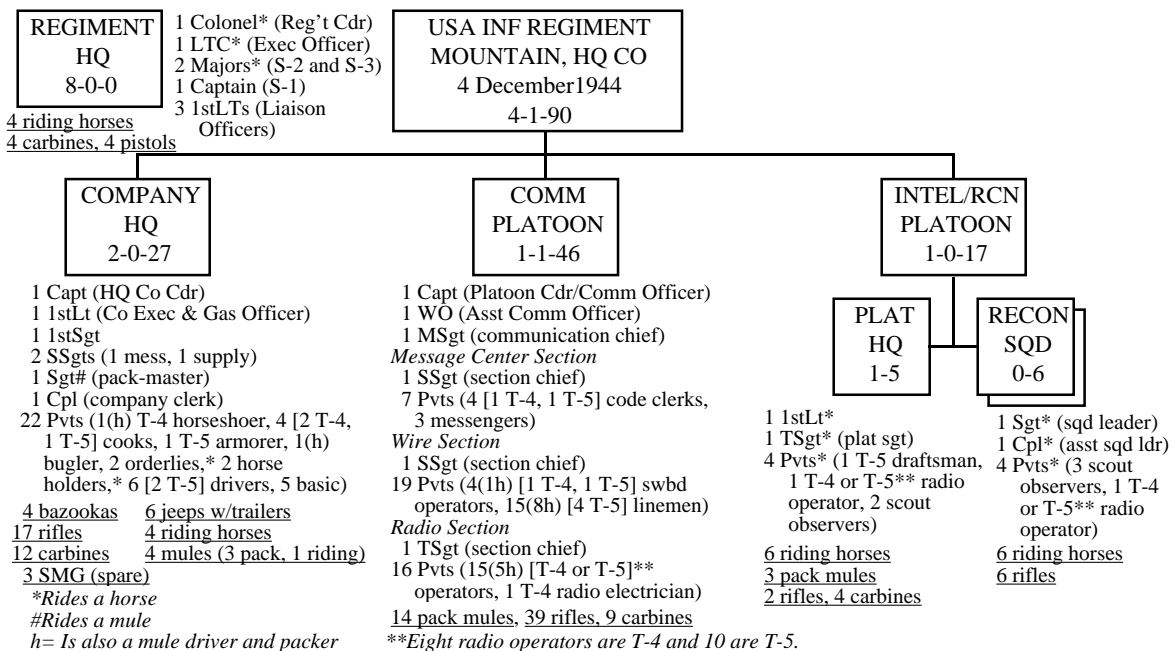
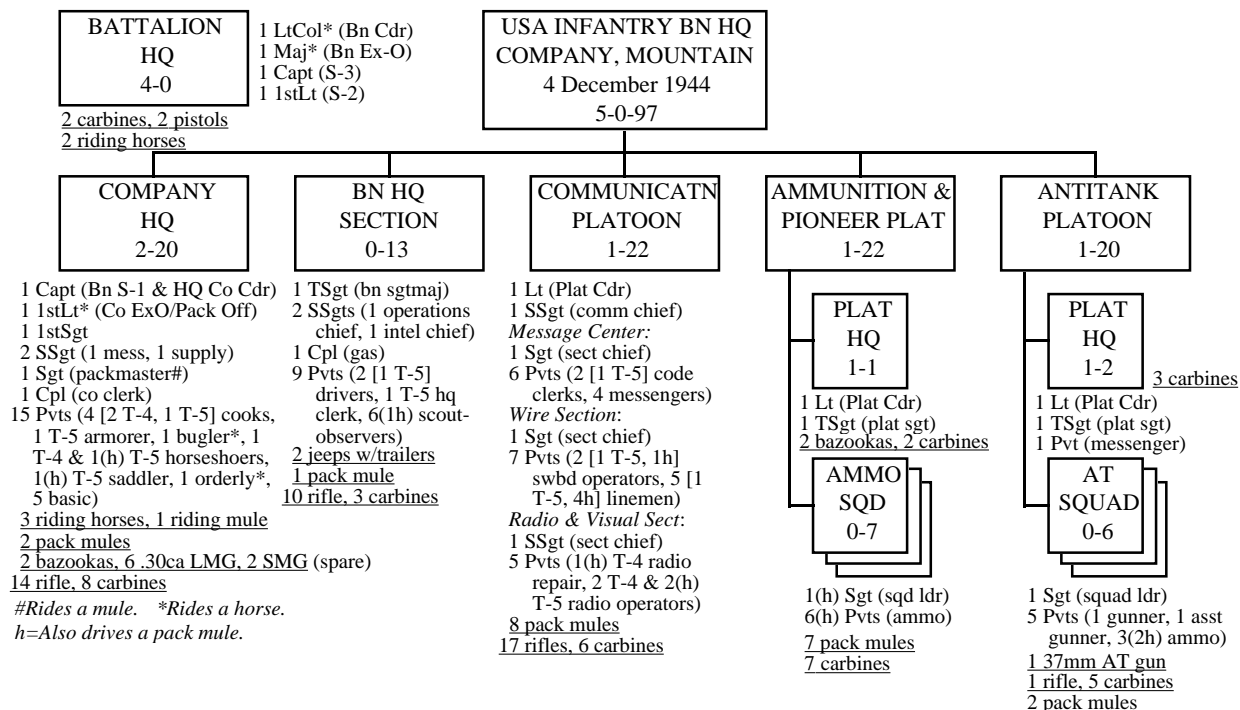

Appendix 6.38 (continued)

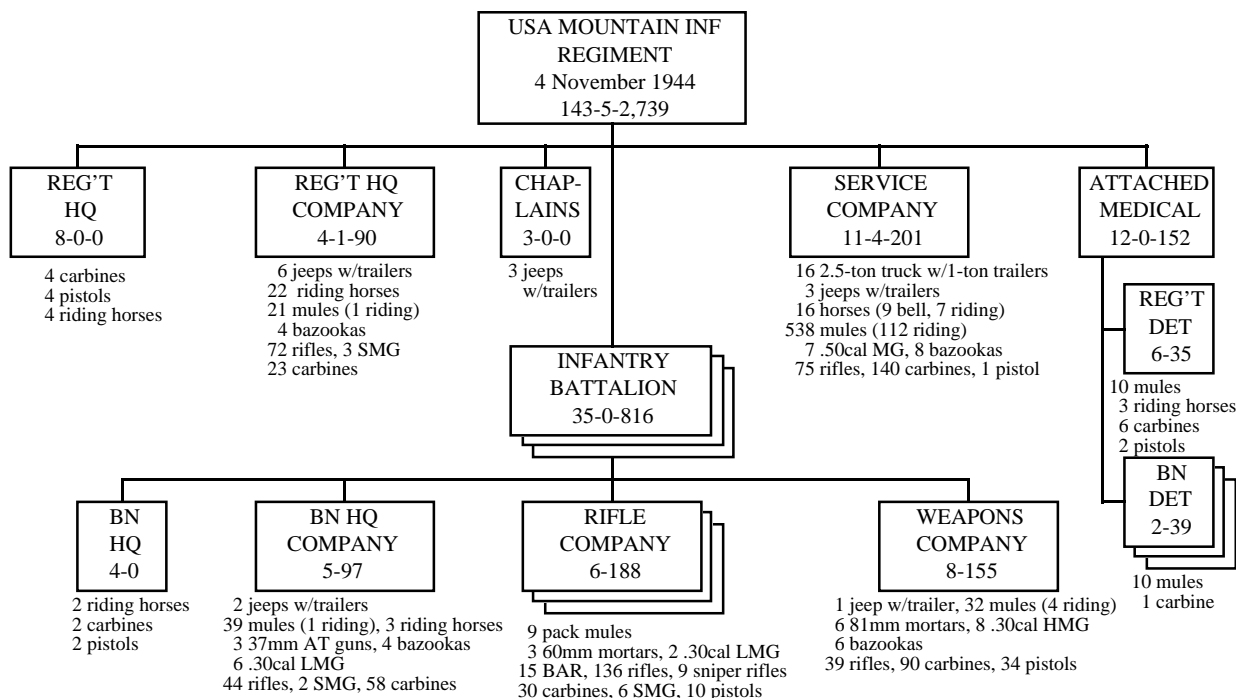
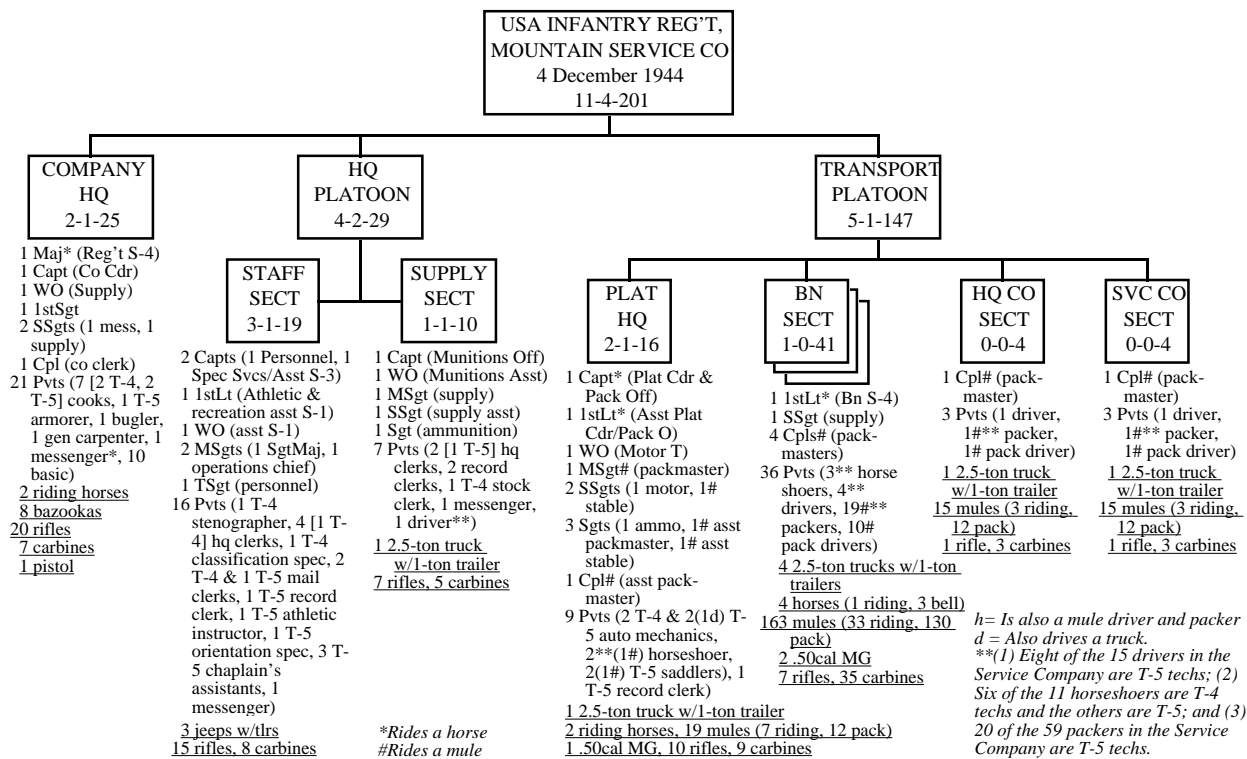

Sources: War Department Tables of Organization 7-131 "Infantry Regiment, Mountain," 7-132 "Headquarters and Headquarters Company, Infantry Regiment, Mountain;" 7-133 "Service Company, Infantry Regiment, Mountain;" 7-76T "Headquarters and Headquarters Company, Infantry Battalion; Mountain;" 7-137 "Infantry Rifle Company, Mountain;" and 7-138 "Infantry Heavy Weapons Company, Mountain" (all Washington DC 4 December 1944).

**Appendix 6.39**

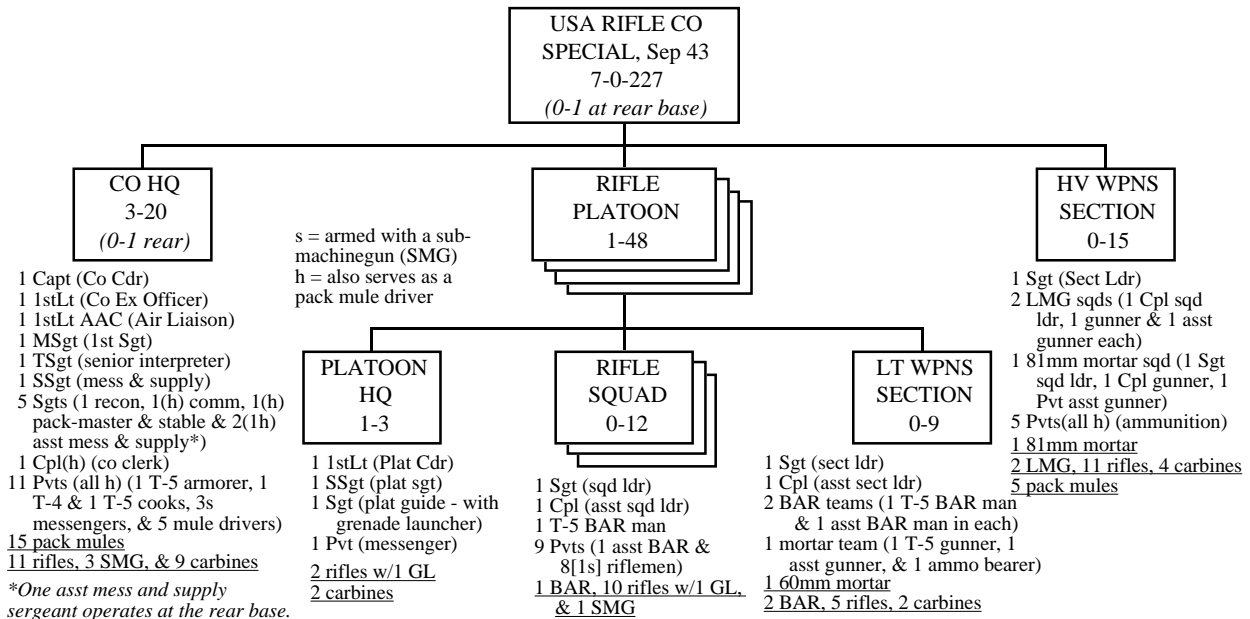
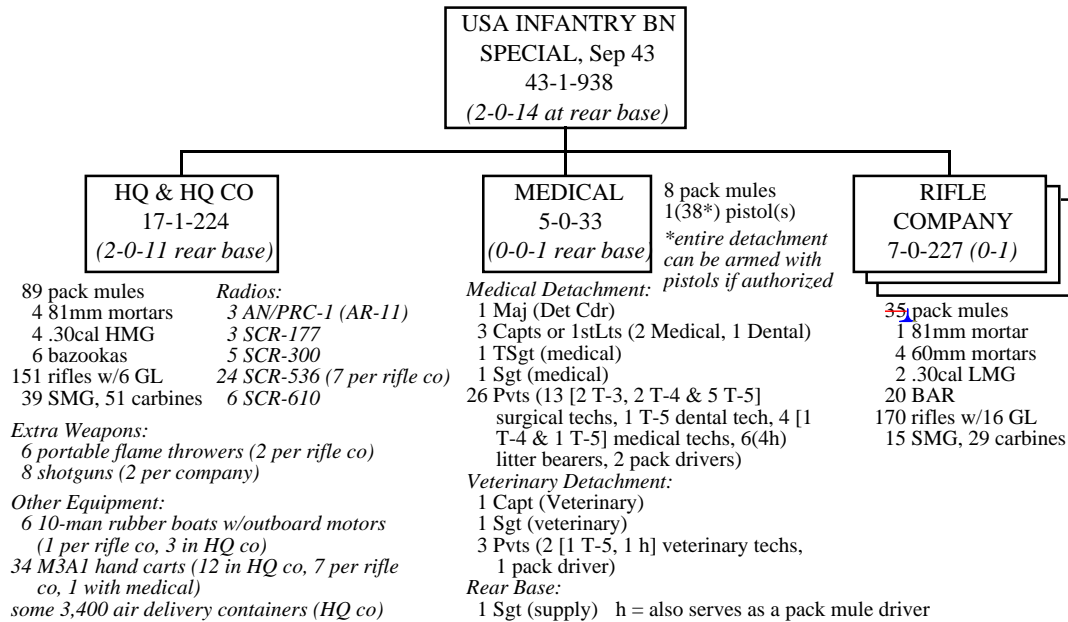

**Notes:**

**Small Arms Distribution:** Sub-machineguns and rifles with grenade launchers are distributed as shown in the diagram. Carbines went to all personnel ranking as staff sergeant or higher, the sergeants in company headquarters (except the two assistant mess and supply sergeants), the light and heavy weapons section leaders, and all mortar and LMG gunners.

**Source:** US Army Tentative T/O&E 7-127 Special "Rifle Company, Infantry Battalion, Special" Record Group 407, Entry 363, US Army Adjutant General Classified Decimal File 1940-45 AG 320.2 Box 1850 US National Archives Washington DC.

Appendix 6.40

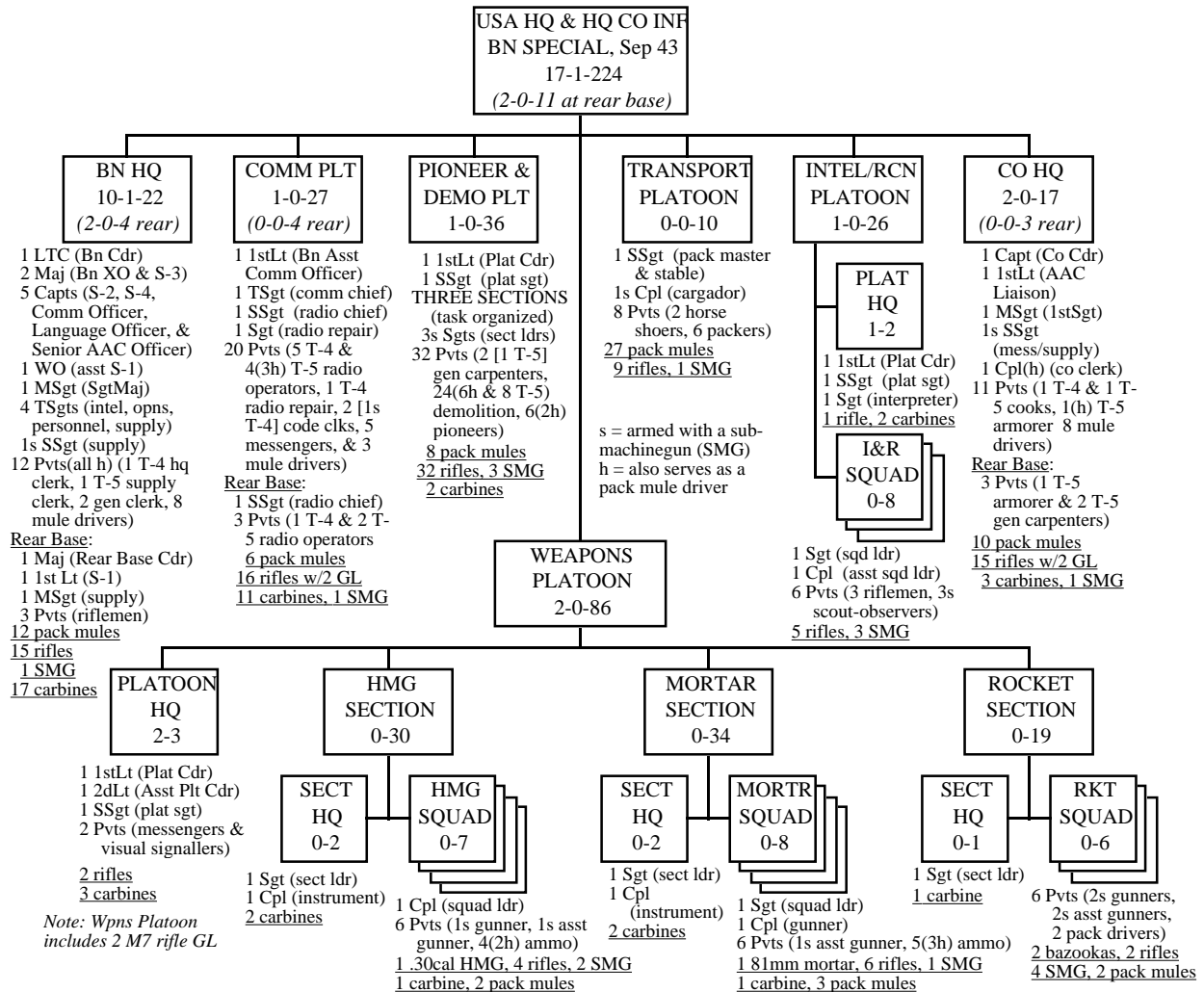

Notes:

**Small Arms Distribution:** Sub-machineguns are issued as shown in the diagram. Carbines distributed to all officers, warrant officers and enlisted personnel ranking as technical sergeants or higher, to all platoon sergeants, section leaders, instrument corporals, HMG squad leaders, mortar gunners, and both radio and visual chiefs, the message center chief and the T-4 radio operators in the communication platoon.

**Source:** US Army Tentative T/O&E 7-126Special "Headquarters and Headquarters Company, Infantry Battalion, Special" Record Group 407, Entry 363, US Army Adjutant General Classified Decimal File 1940-45 AG 320.2 Box 1850 US National Archives Washington DC.

Appendix 6.41

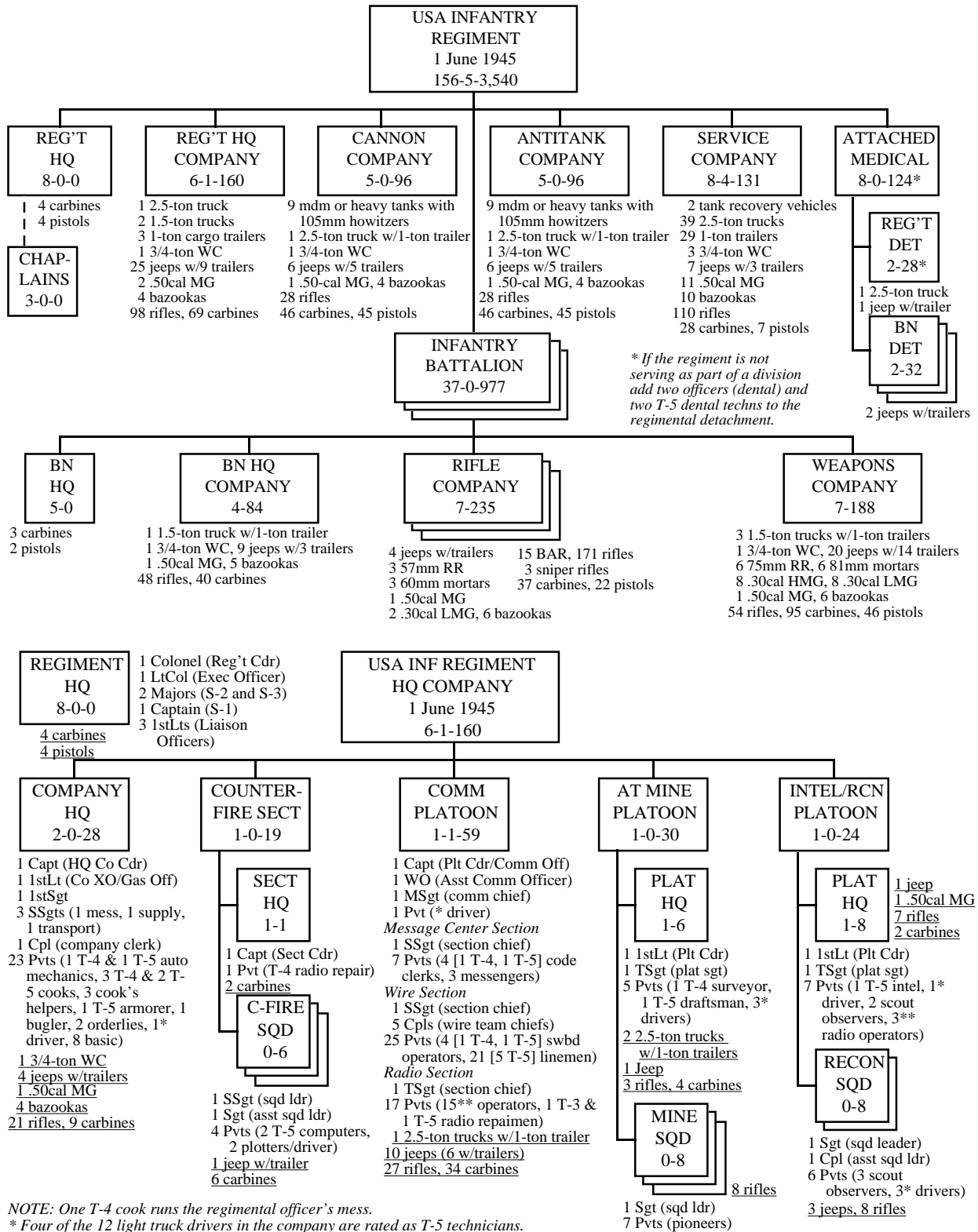

Appendix 6.41 (continued)

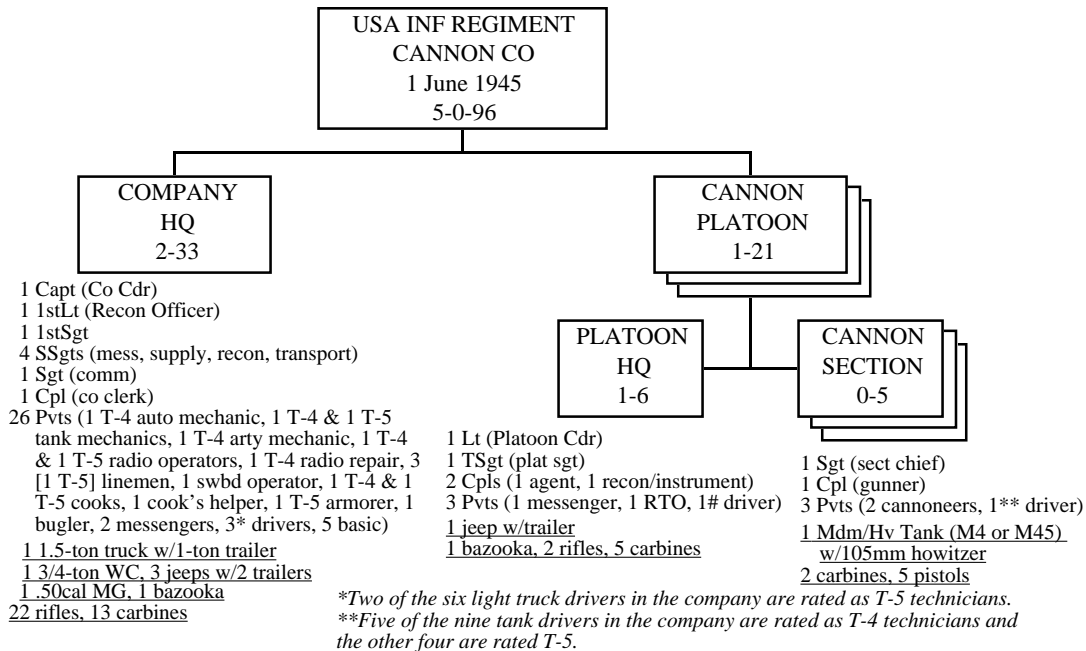
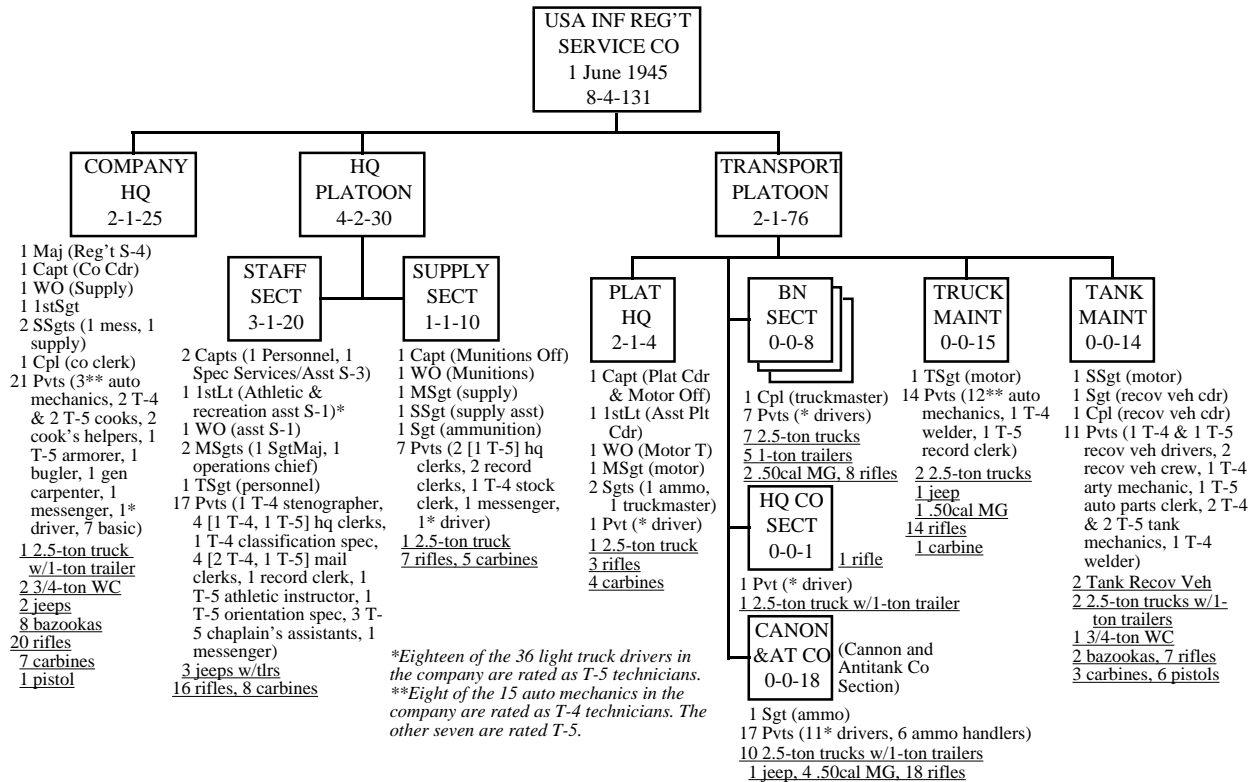

Appendix 6.41 (continued)

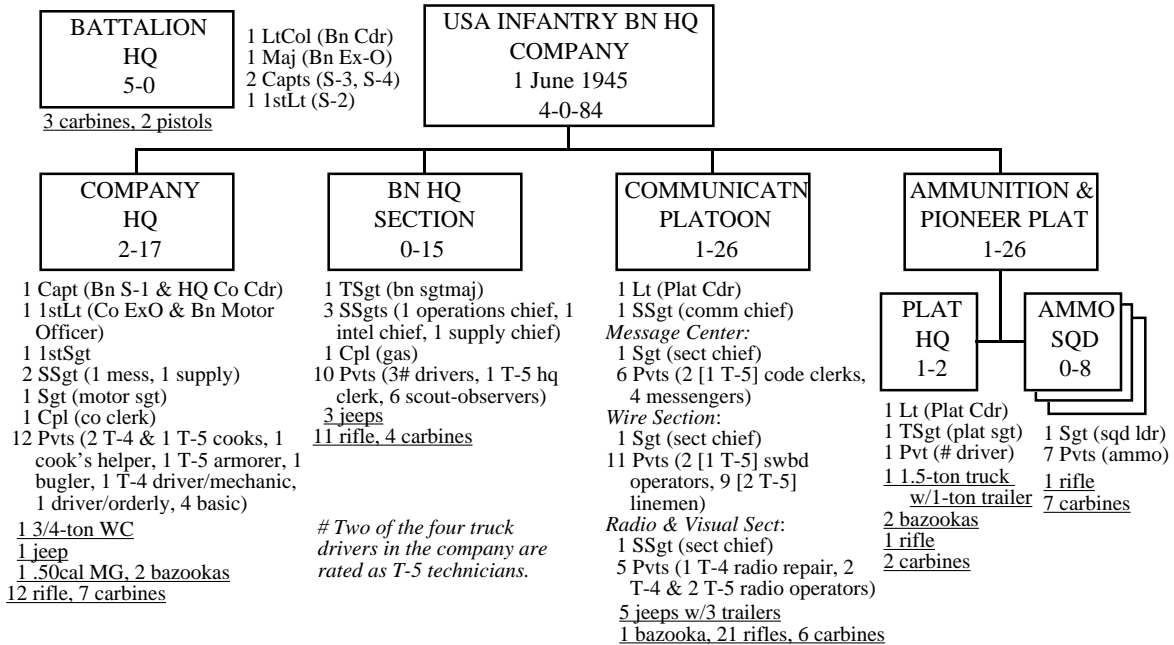
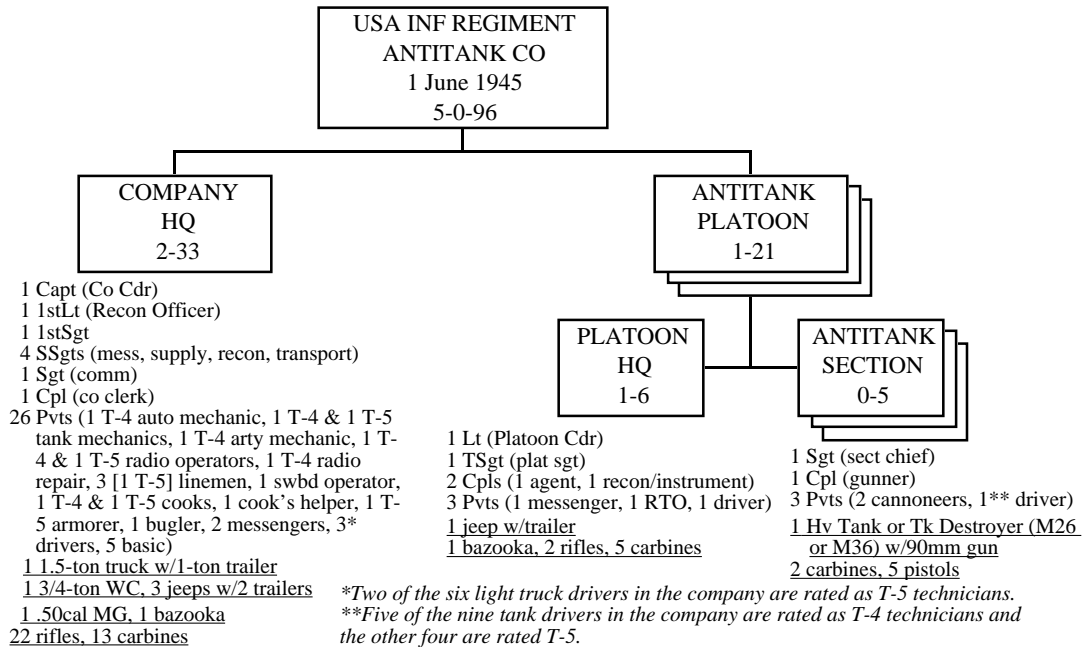

Appendix 6.41 (end)

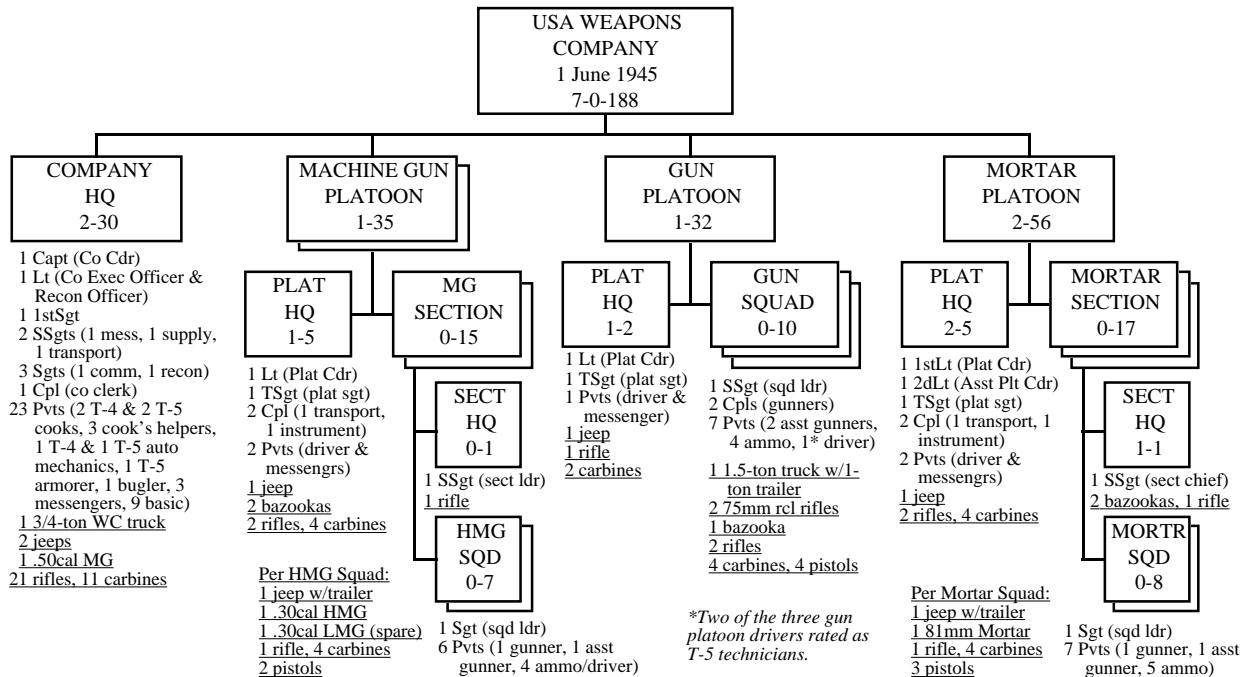
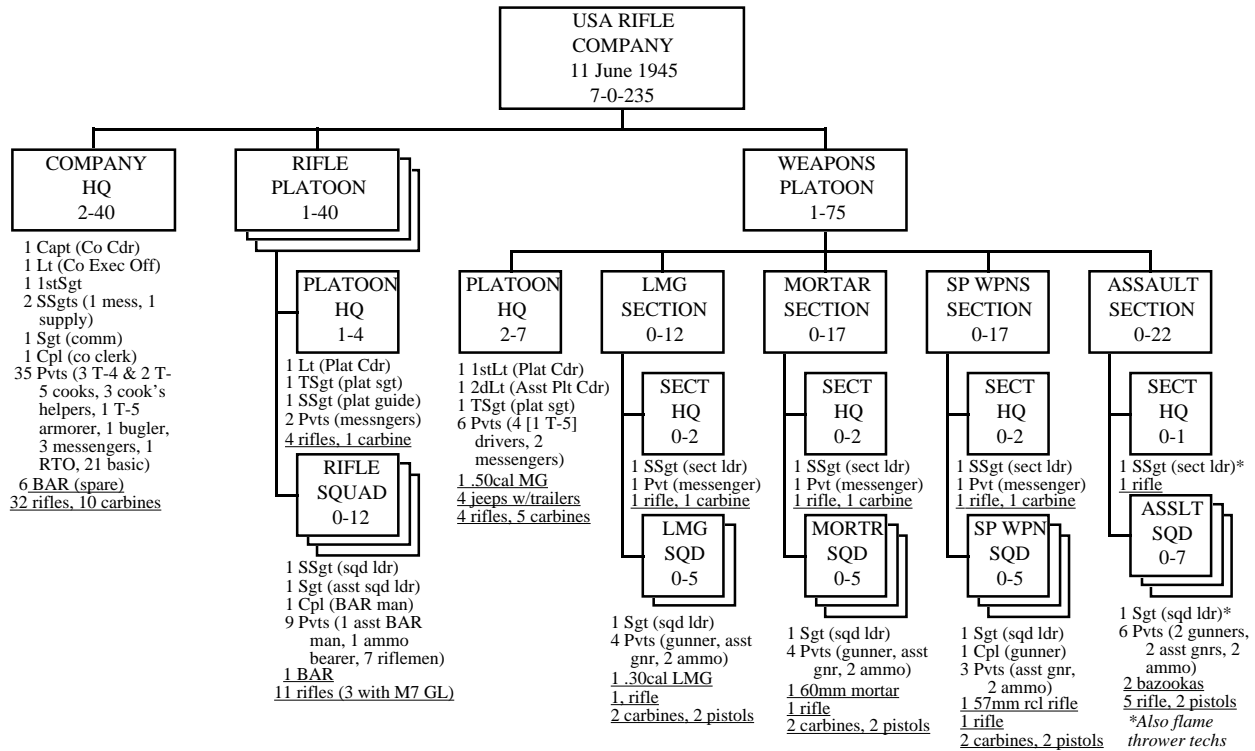

Notes:

**Battalion Headquarters Company:** The tables for this unit were actually missing at the Army research facilities visited by this writer. However the data was easily reconstructed since few changes had been made since June 1944 (see Appendix 5.12) beyond the transfer of the antitank platoon to the battalion weapons company.

**Sources:** War Department Tables of Organization 7-11 "Infantry Regiment;" 7-12 "Headquarters and Headquarters Company, Infantry Regiment;" 7-13 "Service Company, infantry Regiment;" 7-14 "Cannon Company, Infantry Regiment" 7-16 "Headquarters and Headquarters Company, Infantry Battalion;" 7-17 "Infantry Rifle Company" and 7-18 "Infantry Heavy Weapons Company" (all Washington DC 1 June 1945).



## APPENDIX 7

### Appendix 7.1

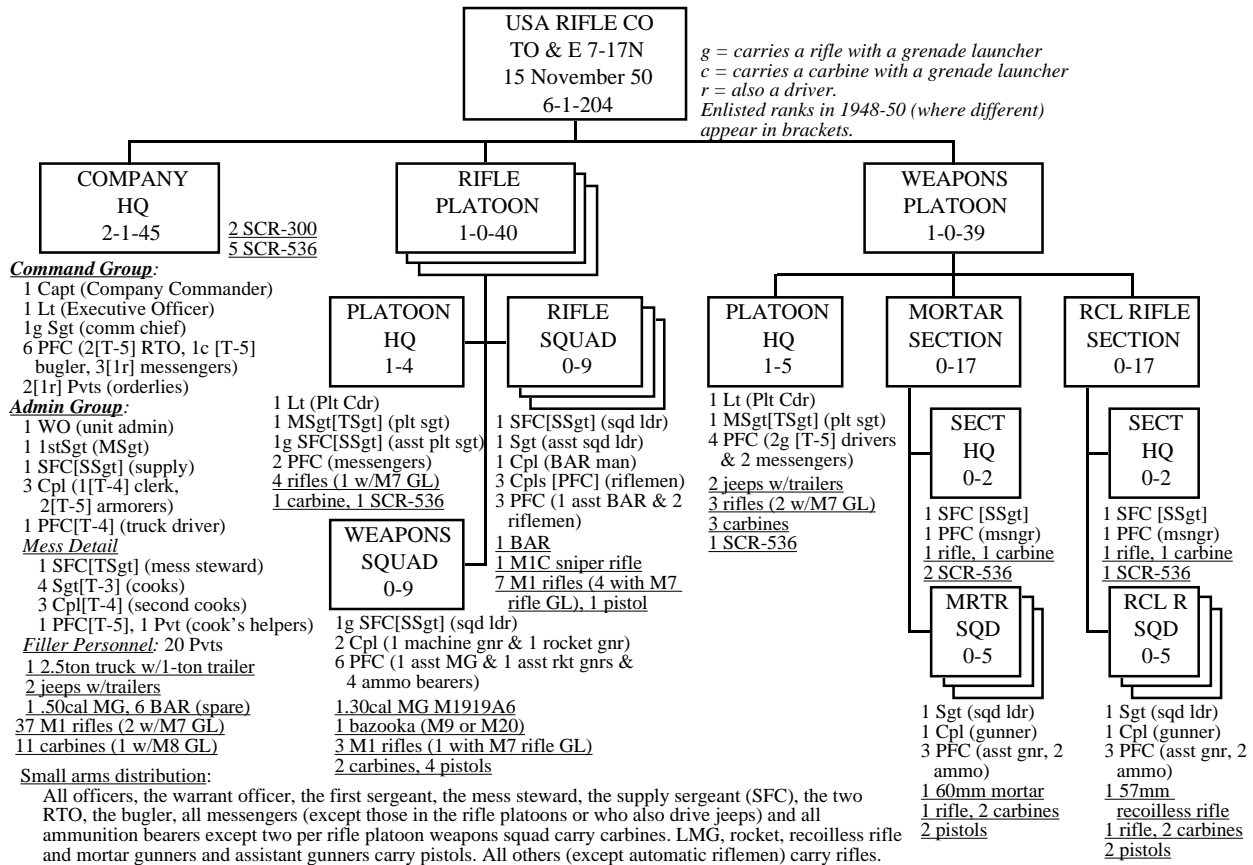

**Notes:**

The Department of the Army first issued tables for its postwar infantry regiment on 16 April 1948. These were the same as those dated November 1950 except that they employed the enlisted rank structure that the Army had used in World War II. The November 1950 tables implemented the new enlisted rank structure that the Army introduced during that year. The diagram shows the rank titles in brackets from the old system where they differ from the new. If this makes the diagram a little confusing then perhaps it captures some of the confusion that the US Army must have experienced as the war caught it as it reorganized. Note that while switching to the new system the Army often replaced its old ranks/pay grades with new ones that were usually higher but there was no uniform policy. Thus a company armorer, who had been a T-5 technician under the old system, became a corporal under the new whereas a T-5 radio-telephone operator only became a PFC. Indeed, T-4 technicians were much more likely to become corporals under the new system and T-3 technicians to become sergeants.

**Company Warrant Officer:** About December 1949 each company received a warrant officer as unit administrator. In the case of the rifle company the Army eliminated a cook's helper (not shown above) so that the warrant officer would not increase the company's total strength.

**Company Motor Vehicles:** Except for driver maintenance the battalion headquarters company and the regimental service company are responsible for the maintenance of rifle company vehicles.

**Source:** Department of the Army Table of Organization 7-17N "Infantry Rifle Company" (Washington DC 21 April 1948 and 15 November 1950).

## Appendix 7.2

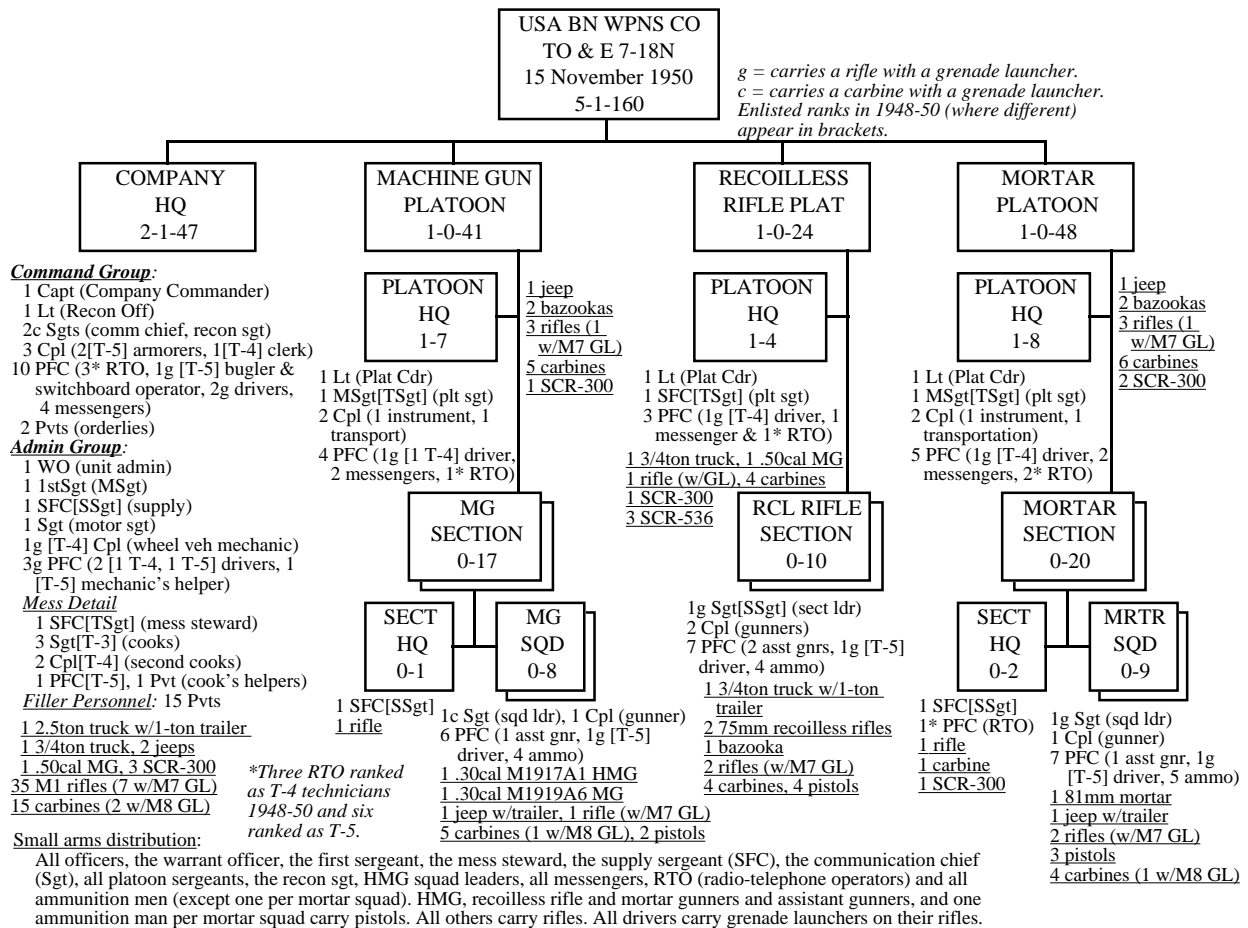

**Notes:**

The Department of the Army first issued tables for its postwar infantry regiment on 16 April 1948. These were the same as those dated November 1950 except that they employed the enlisted rank structure that the Army had used in World War II. The November 1950 tables implemented the new enlisted rank structure that the Army introduced during that year. The diagram shows the rank titles in brackets from the old system where they differ from the new. If this makes the diagram a little confusing then perhaps it captures some of the confusion that the US Army must have experienced as the war caught it as it reorganized. Note that while switching to the new system the Army often replaced its old ranks/pay grades with new ones that were usually higher but there was no uniform policy. Thus a company armorer, who had been a T-5 technician under the old system, became a corporal under the new whereas a T-4 or T-5 radio-telephone operator or driver only became a PFC. Indeed, T-4 technicians were more likely to become corporals under the new system and T-3 technicians to become sergeants.

**Company Warrant Officer:** About December 1949 each company received a warrant officer as unit administrator.

**Source:** Department of the Army Table of Organization 7-18N "Infantry Heavy Weapons Company" (Washington DC 21 April 1948 and 15 November 1950).

### Appendix 7.3

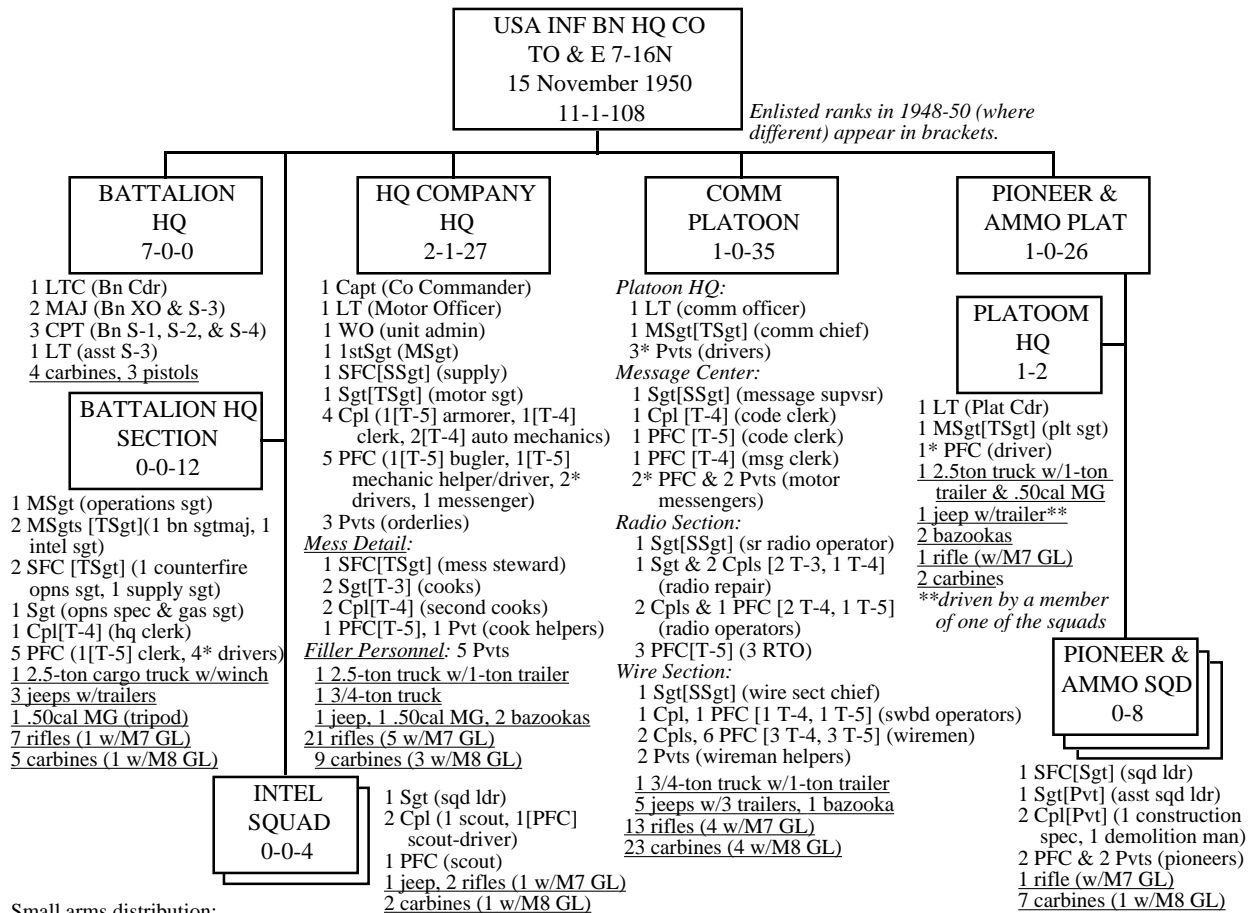

**Small arms distribution:**

Field grade officers (majors, lieutenant colonel) carry pistols. Rifles issued to filler personnel, cooks, cook's helpers, the armorer, clerks, wheeled vehicle mechanics, mechanic's helpers, orderlies, drivers (including motor messengers), radio mechanics, switchboard operators, the pioneer and intelligence squad leaders and the operations specialist (sgt) all carry rifles. All others carry carbines.

**Notes:**

The Department of the Army first issued tables for its postwar infantry regiment on 16 April 1948. These were the same as those dated November 1950 except that they employed the enlisted rank structure that the Army had used in World War II. The November 1950 tables implemented the new enlisted rank structure that the Army introduced during that year. The diagram shows the rank titles in brackets from the old system where they differ from the new. If this makes the diagram a little confusing then perhaps it captures some of the confusion that the US Army must have experienced as the war caught it as it reorganized. Note that while switching to the new system the Army often replaced its old ranks/pay grades with new ones that were usually higher but there was no uniform policy. Thus a company armorer, who had been a T-5 technician under the old system, became a corporal under the new whereas a T-5 radio-telephone operator or driver only became a PFC. Indeed, T-4 technicians were more likely to become corporals under the new system and T-3 technicians to become sergeants. Though enlisted rank tended to increase under the new system a T-4 technician might only become a PFC (an actual drop in both rank and pay grade).

**Company Warrant Officer:** About December 1949 each company received a warrant officer as unit administrator.

**Pioneer and Ammunition Squads:** In 1948 these had only a sergeant (squad leader) and seven privates (pioneers) each. In November 1950, in order to improve the squads hitherto merely nominal engineering capabilities the Army replaced three privates with an assistant squad leader, a construction specialist and a demolition specialist.

**Additional Duties:** The battalion assistant S-3 (in battalion headquarters) doubled as the battalion troop information and education officer. The battalion motor officer was also the headquarters company executive officer.

**Source:** Department of the Army Table of Organization 7-16N "Headquarters and Headquarters Company, Infantry Battalion" (Washington DC 21 April 1948 and 15 November 1950).

## Appendix 7.4

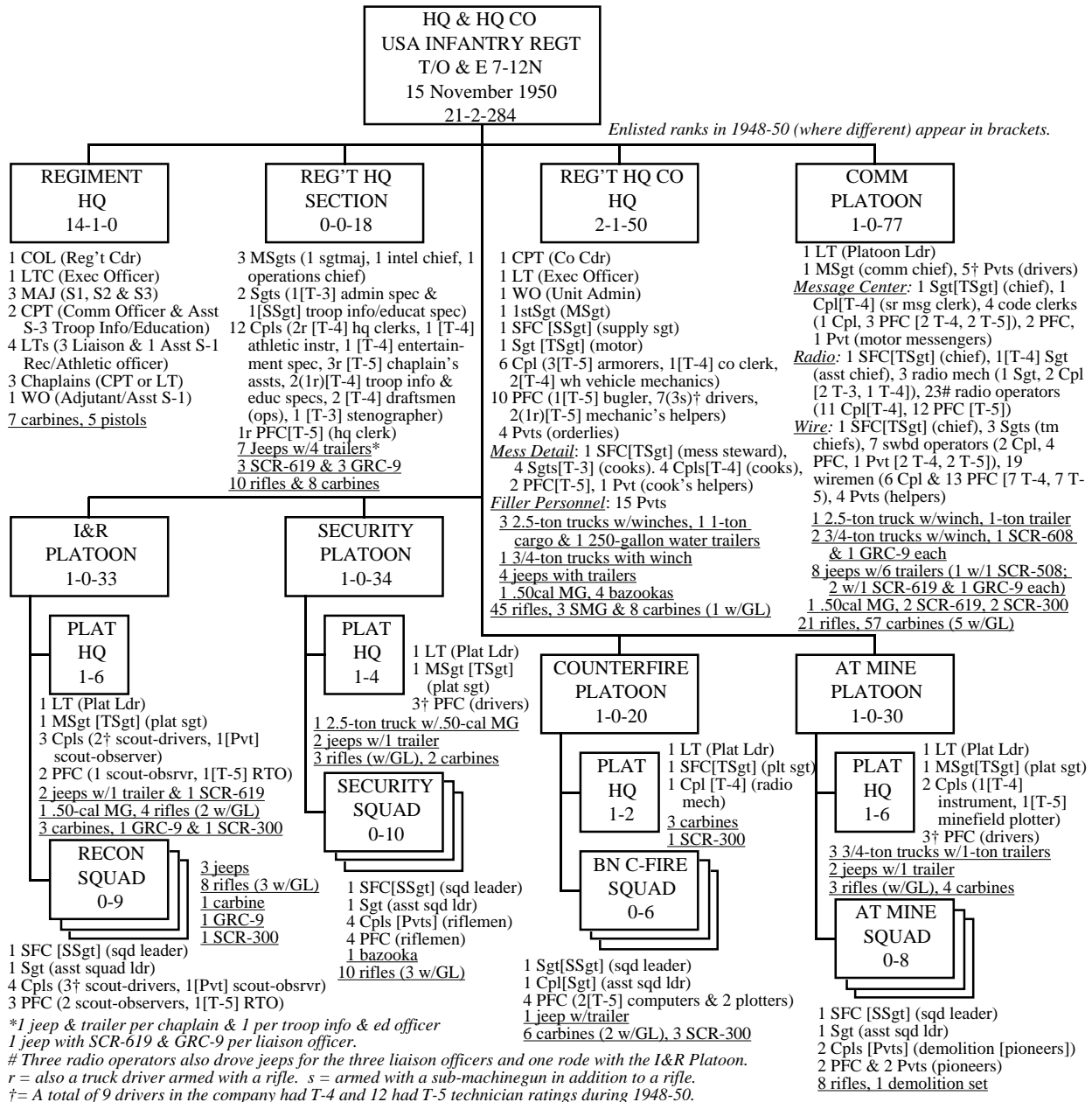

**Notes:**

The Department of the Army first issued tables for its postwar infantry regiment on 16 April 1948. These were the same as those dated November 1950 except that they employed the enlisted rank structure that the Army had used in World War II. See the notes under Appendices 7.1 through 7.3.

**Company Warrant Officer:** About December 1949 each company received a warrant officer as unit administrator. At about the same time the company mess detail lost its staff sergeant assistant mess steward (not shown in the diagram above).

**Antitank Mine Platoon:** In November 1950 the Army improved its engineering capabilities by replacing two privates (pioneers) per squad with two (corporal) demolition specialists.

**Source:** Department of the Army Table of Organization 7-12N "Headquarters and Headquarters Company, Infantry Regiment" (Washington DC 21 April 1948 and 15 November 1950).

## Appendix 7.5

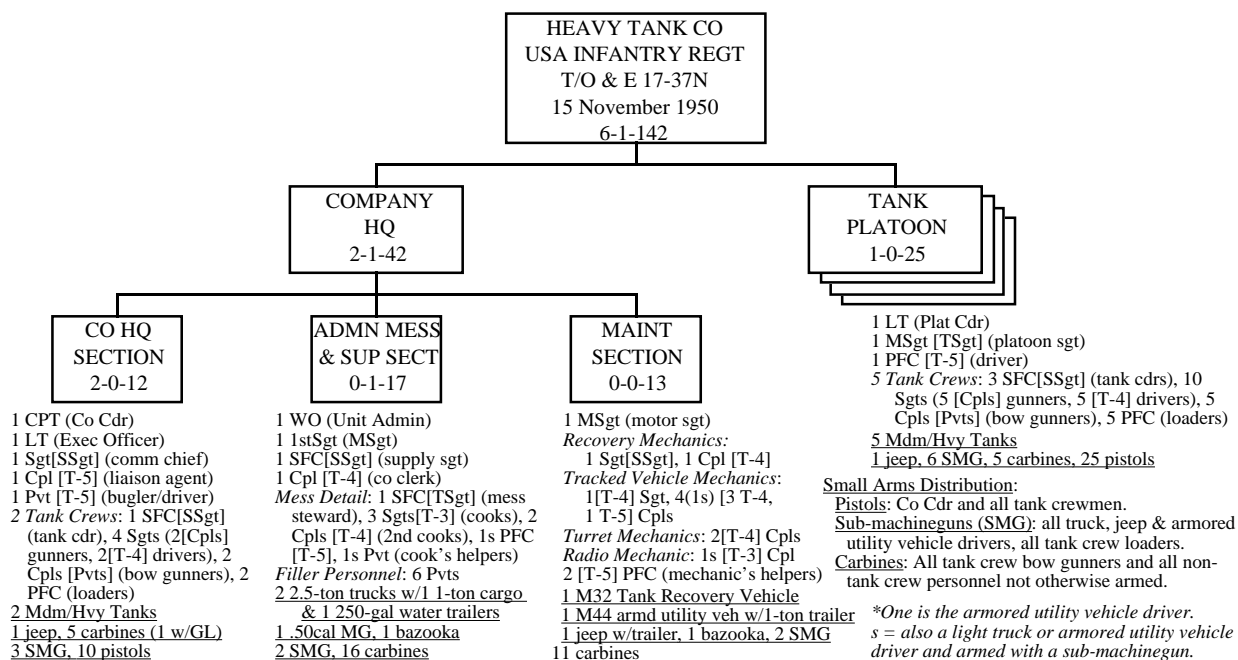

**Notes:**

The Department of the Army first issued tables for its postwar infantry regiment on 16 April 1948. These were the same as those dated November 1950 except that they employed the enlisted rank structure that the Army had used in World War II. See the notes under Appendices 7.1 through 7.3.

**Company Warrant Officer:** About December 1949 each company received a warrant officer as unit administrator.

**Tank Crew:** Prior to November 1950 a tank commander was a staff sergeant (or a lieutenant or a technical sergeant if he was also a platoon leader or platoon sergeant), a corporal was the gunner, a T-4 technician was driver and the bow gunner and loader were privates without technician ratings. After November 1950 the tank commander was a sergeant first class (or lieutenant or master sergeant if also a platoon leader or platoon sergeant). His gunner and driver were sergeants, his bow gunner was a corporal and his loader was a PFC.

**Tanks:** A tank company organic to an infantry regiment would be most likely to have M4A3 Sherman tanks armed with 76mm guns. None of the infantry regiment tank companies that fought in Korea during 1950-51 had M26 *Pershings* or M46 *Pattons*. Initial plans were for the two tanks in the company headquarters section to carry 105mm howitzers but this rarely occurred and the Army dropped this requirement in 1950. Tank companies assigned to tank battalions frequently had a section of M4A3 tanks armed with 105mm howitzers and equipped with dozer blades attached to them but this does not appear to have occurred to tank companies in infantry regiments.

**Source:** Department of the Army Table of Organization 17-37N "Tank Company, Heavy or Medium, Infantry Regiment" (Washington DC 21 April 1948 and 15 November 1950).

## Appendix 7.6

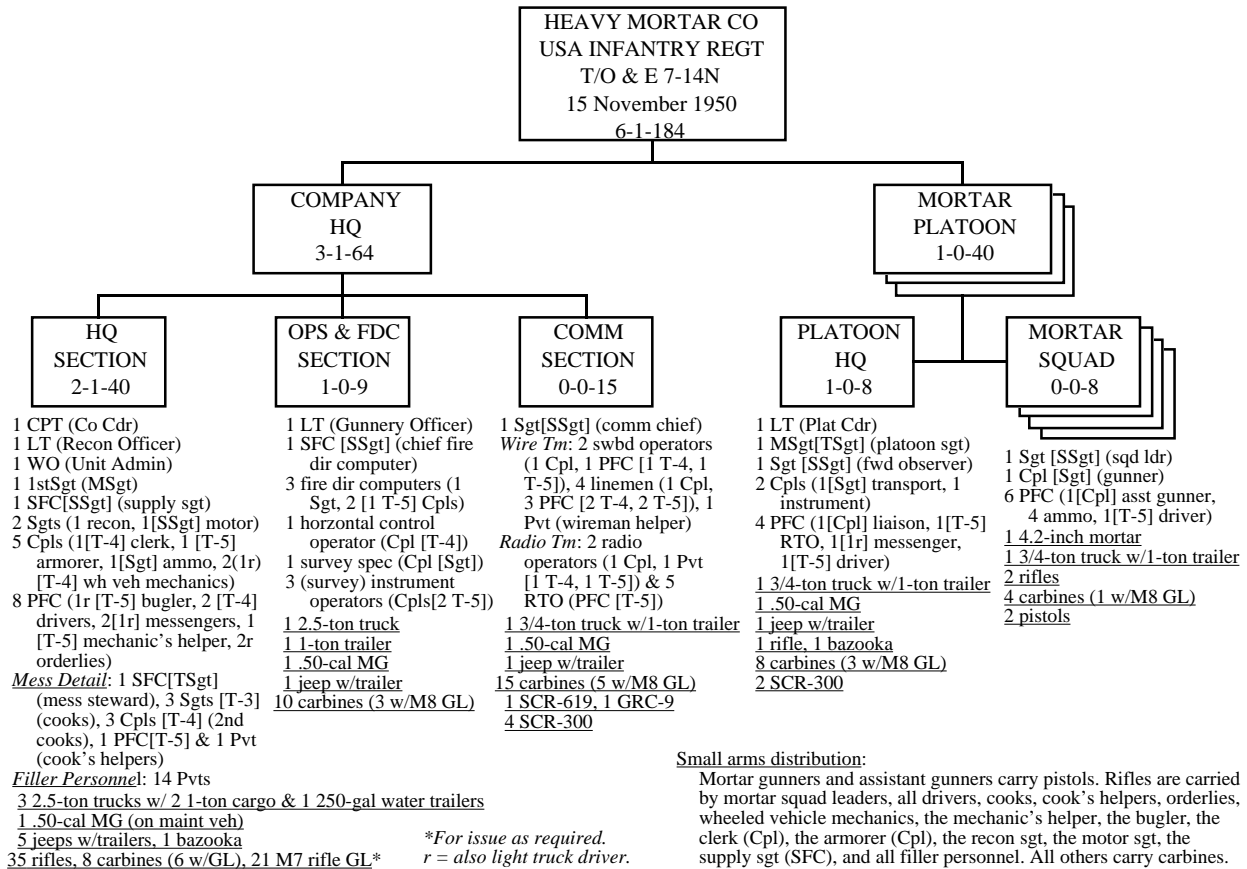

**Notes:**

The Department of the Army first issued tables for its postwar infantry regiment on 16 April 1948. These were the same as those dated November 1950 except that they employed the enlisted rank structure that the Army had used in World War II. See the notes under Appendices 7.1 through 7.3.

**Company Warrant Officer:** About December 1949 each company received a warrant officer as unit administrator.

**Command Group:** An informal command and reconnaissance group commonly formed by the mortar company headquarters for combat operations would consist of the company commander, reconnaissance officer, first sergeant, the reconnaissance sergeant, the bugler, two messengers and two orderlies plus radio operators and/or RTO from the communication section. Its preferred vehicle was the 3/4-ton truck from the communication section, though it would probably use jeeps as well. The remainder of the headquarters section of the company headquarters formed the administrative group.

**Source:** Department of the Army Table of Organization 7-14N "Infantry Heavy Mortar Company" (Washington DC 21 April 1948 and 15 November 1950).

## Appendix 7.7

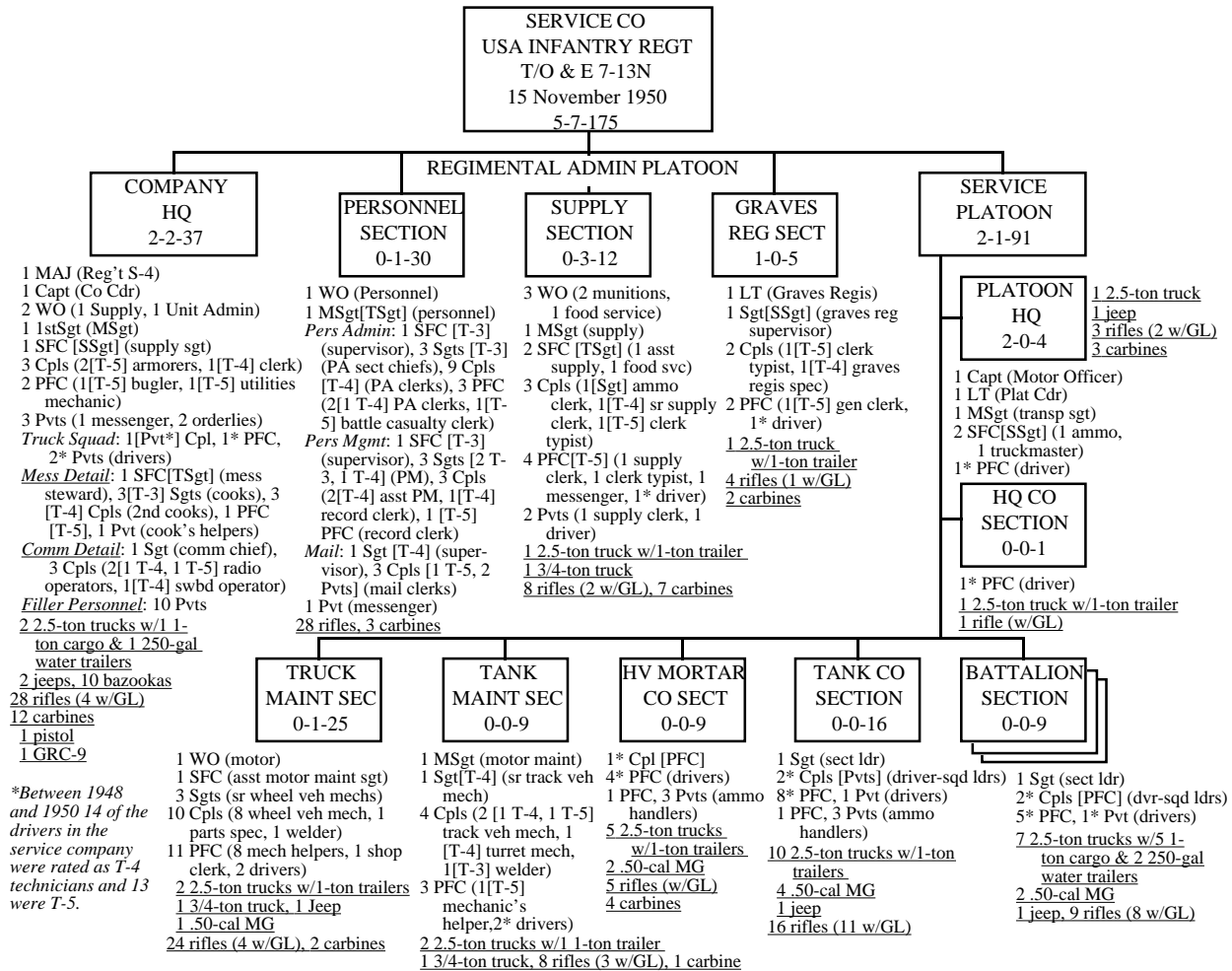

**Notes:**

The Department of the Army first issued tables for its postwar infantry regiment on 16 April 1948. These were the same as those dated November 1950 except that they employed the enlisted rank structure that the Army had used in World War II. See the notes under Appendices 7.1 through 7.3.

**Company Warrant Officer:** About December 1949 each company received a warrant officer as unit administrator.

**Source:** Department of the Army Table of Organization 7-13N "Infantry Regiment Service Company" (Washington DC 21 April 1948 and 15 November 1950).

## Appendix 7.8

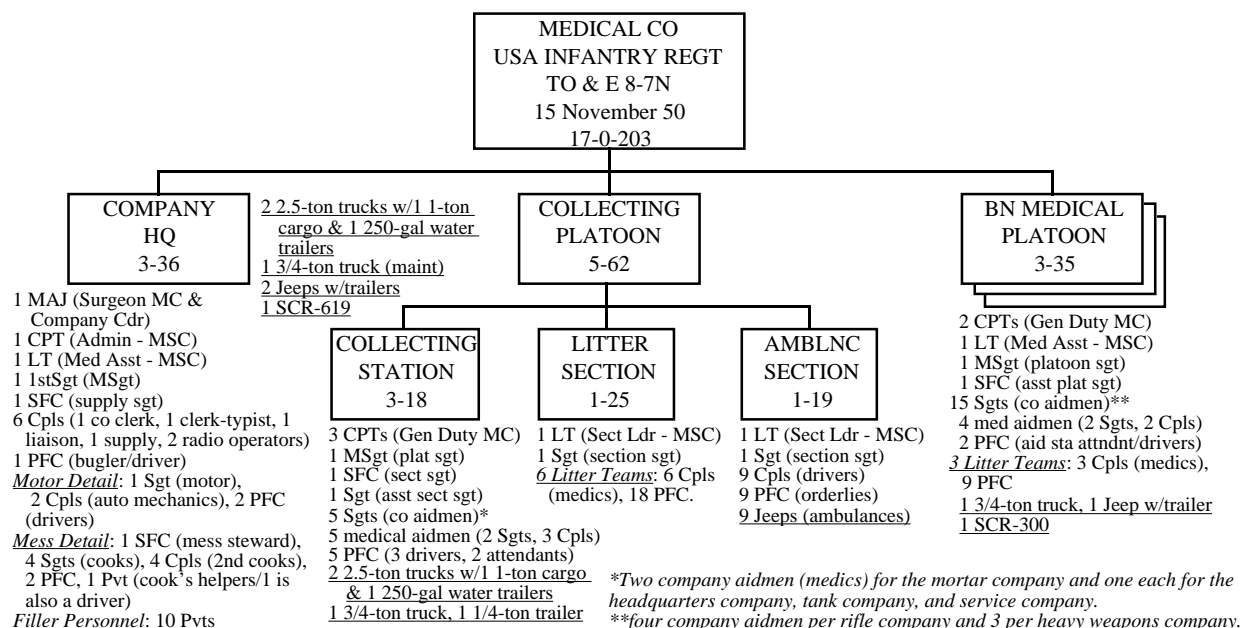

**Notes:**

**November 1950:** The medical company experienced more change at this time than the other companies in the regiment (see Appendices 7.1 through 7.3) and the changes are too numerous to show in the diagram. The company expanded from 13 officers and 201 men to 17 officers and 203. Unlike the other companies it did not receive a warrant officer administrative clerk. The extra officers were general duty medical corps types added to the company headquarters and the three battalion platoons. Medical Service Corps officers (designated MSC above), though they had sufficient training to give limited medical care they were more concerned with medical supply and administration. The medical company mess detail originally included a staff sergeant assistant mess steward but he was eliminated in November 1950. In his place the Army added two radio operators (for the company's jeep mounted SCR-619 radio) and a supply corporal to company headquarters.

**Rank Changes:** These were as follows: (1) The four platoon sergeants went from technical sergeant to master sergeant but the mess steward only went from technical sergeant to sergeant first class (SFC). (2) The company supply sergeant and the section sergeant for the collecting station went from staff sergeant to SFC but the other staff sergeants (the company motor sergeant and the section sergeants for the litter and ambulance sections) became sergeants only. However the medical sergeant in each battalion medical platoon in 1948 became an SFC and assistant platoon sergeant in 1950. However the sergeant liaison agent in 1948 became a corporal in 1950 but the assistant section sergeant in the collecting station in 1948 remained a sergeant in 1950. (3) There were no other non-commissioned officers in the medical company in 1948. All other NCO's created in 1950 had been technicians. (4) In the company headquarters the sergeant cooks had been T-3, the corporal cooks T-4, the PFC cook's helper T-5, the company clerk and clerk typist had been T-4, the bugler and one truck driver had been a T-5, and the two corporal auto mechanics had been a T-4 and a T-5, respectively. (5) In the collecting station two of the five sergeants company aidmen had been T-3 technicians and the other three had been T-4. Four medical aidmen (one T-3, two T-4 and one T-5) and three surgical technicians (one T-3, one T-4 and one T-5) in 1948 became five medical aidmen (two sergeants and three corporals) and two collection station attendants (PFC). One of the three drivers had been a T-4 technician and another had been a T-5. (6) Each of the six litter teams in the litter section went from one T-5 surgical technician and three privates to one corporal and three PFC. (7) Three of the nine drivers in the ambulance section in 1948 had been T-4 technicians and three had been T-5. The other three drivers and the nine orderlies were unrated privates. (8) In each battalion medical platoon the 15 company aidmen (sergeants) had been eight T-3 technicians and 7 T-4 in 1948. The four medical aidmen and two aid station attendants had been two T-4 surgical technicians and four medical technicians (one T-4, one T-5 and two unrated who doubled as drivers). The three litter teams in each battalion platoon changed in the same way as those in the company litter section.

**Source:** Department of the Army Table of Organization 8-7N "Medical Company, Infantry Regiment" (Washington DC 21 April 1948 and 15 November 1950).



## Appendix 7.9

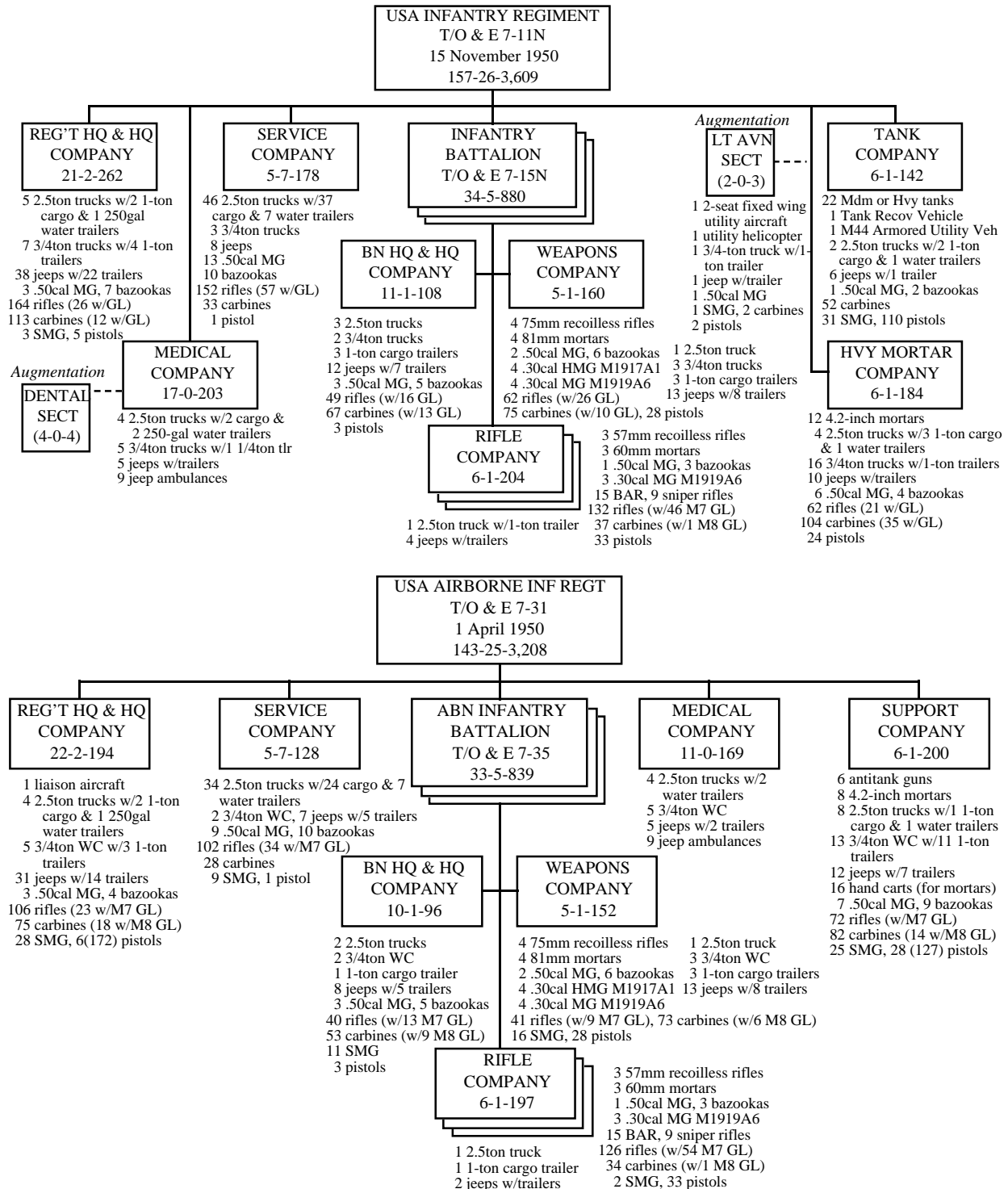

Notes:

Sources: Department of the Army Tables of Organization 7-11N "Infantry Regiment" and 7-15R "Infantry Battalion" (Washington DC 21 April 1948 and 15 November 1950) and 7-31 "Infantry Regiment, Airborne" and 7-35 "Infantry Battalion, Airborne" (Washington DC 1 April 1950).

Appendix 7.10

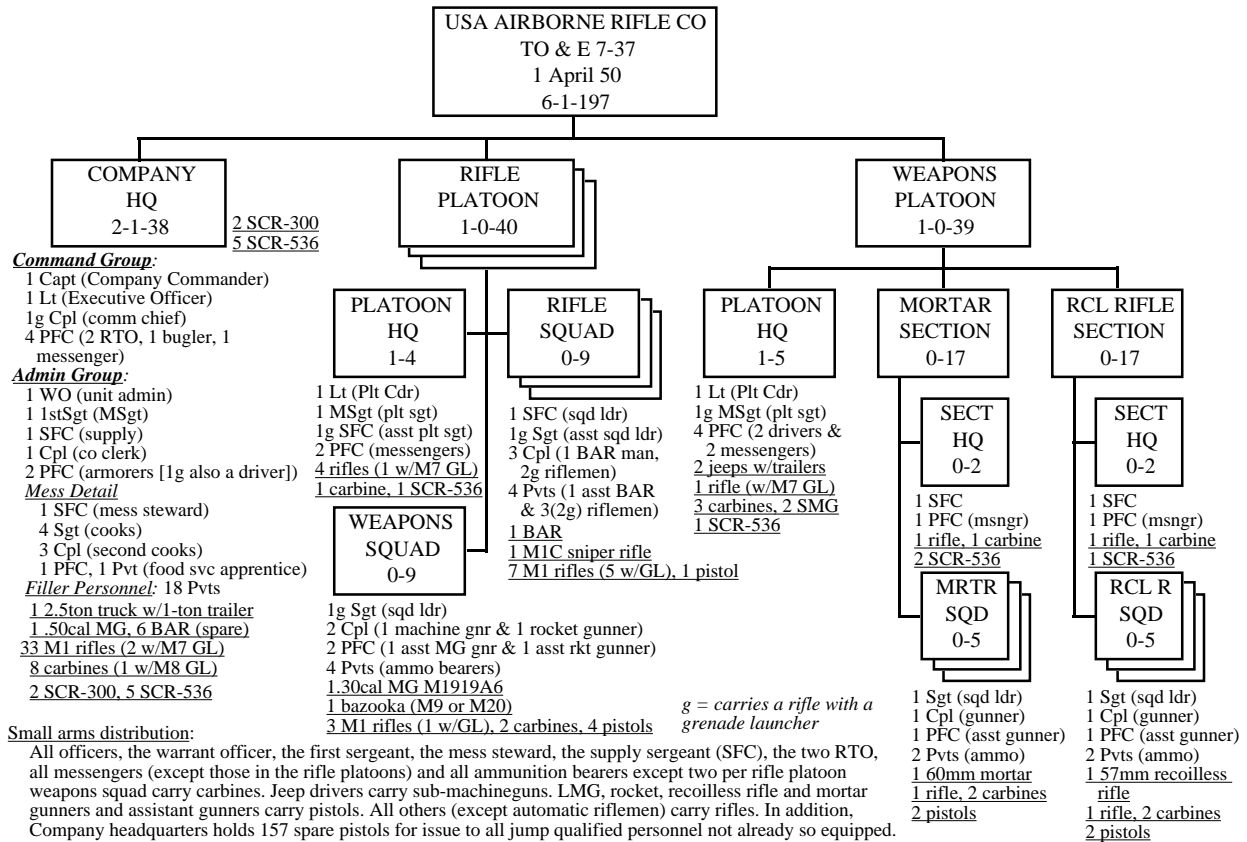

Notes:

Non airborne-qualified personnel would include the warrant officer unit administrator, all members of the mess detail and all drivers (including the armorer who drives the company's 2.5-ton truck).

Source: Department of the Army Table of Organization 7-37 "Airborne Infantry Rifle Company" (Washington DC 1 April 1950).

Appendix 7.11

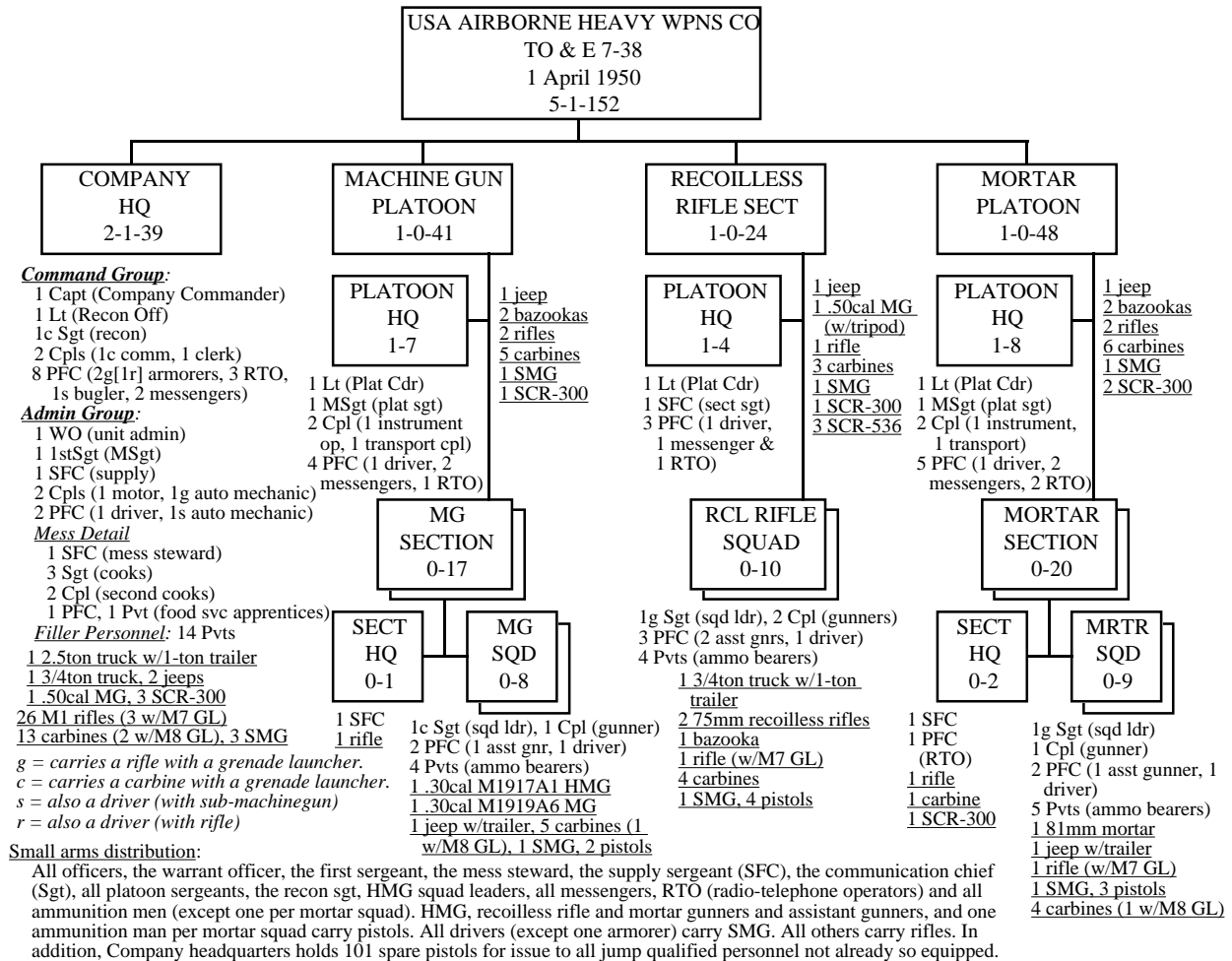

Notes:

Non airborne-qualified personnel would include the warrant officer unit administrator, all members of the mess detail, the transportation and motor corporals and all drivers.

Source: Department of the Army Table of Organization 7-38 "Airborne Infantry Heavy Weapons Company" (Washington DC 1 April 1950).

Appendix 7.12

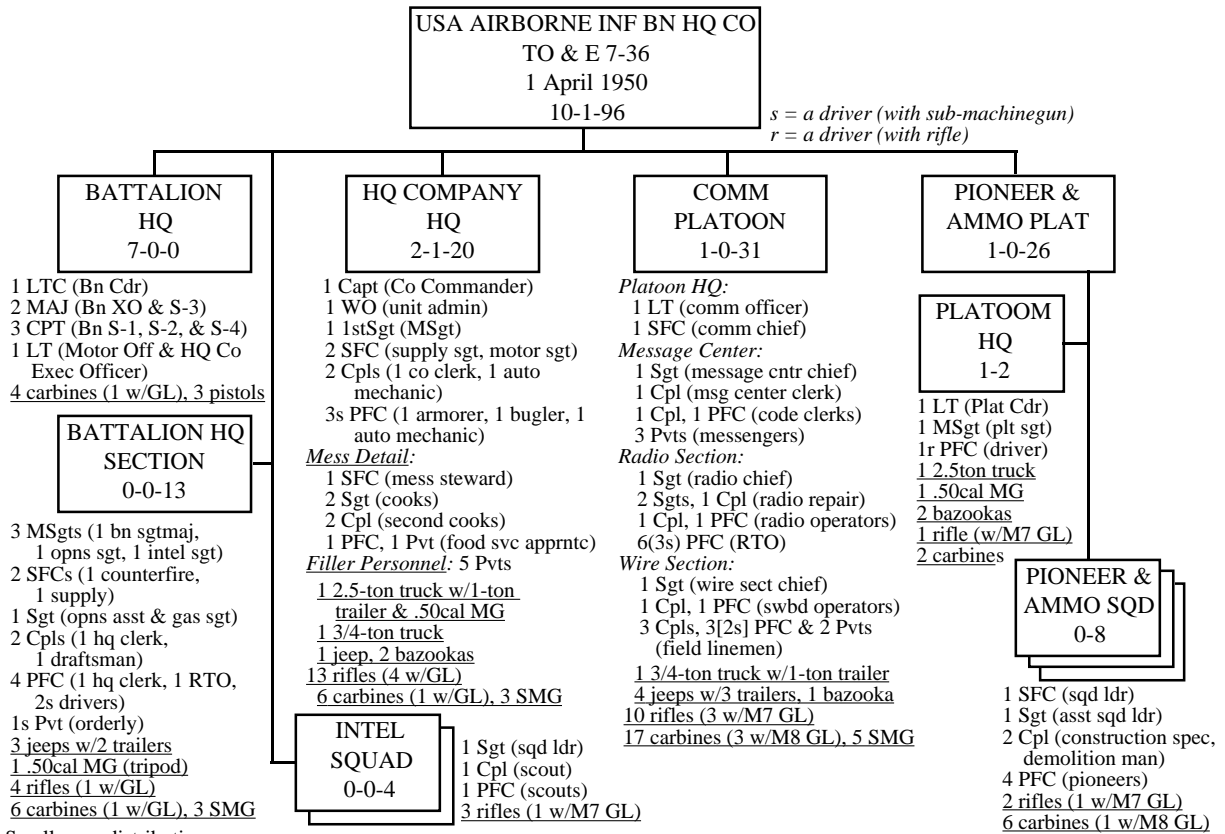

Small arms distribution:

Field grade officers (majors, lieutenant colonel) carry pisols. Carbines issued to all other officers, the warrant officer, the first sergeant, master sergeants, sergeants first class, pioneers ranking below sergeant, field linemen, messengers, RTO (who are not also drivers) and the message center, wire and radio chiefs. Most drivers carry sub-machineguns (as marked). All others carry rifles. In addition, Company headquarters holds 91 spare pistols for issue to all jump qualified personnel not already so equipped.

Notes:

Non airborne-qualified personnel would include the warrant officer unit administrator, all members of the mess detail and selected drivers (probably those in the battalion headquarters section and pioneer platoon and the armorer in company headquarters who drives the 2.5-ton truck).

Source: Department of the Army Table of Organization 7-36 "Headquarters and Headquarters Company, Airborne Infantry Battalion" (Washington DC 1 April 1950).

Appendix 7.13

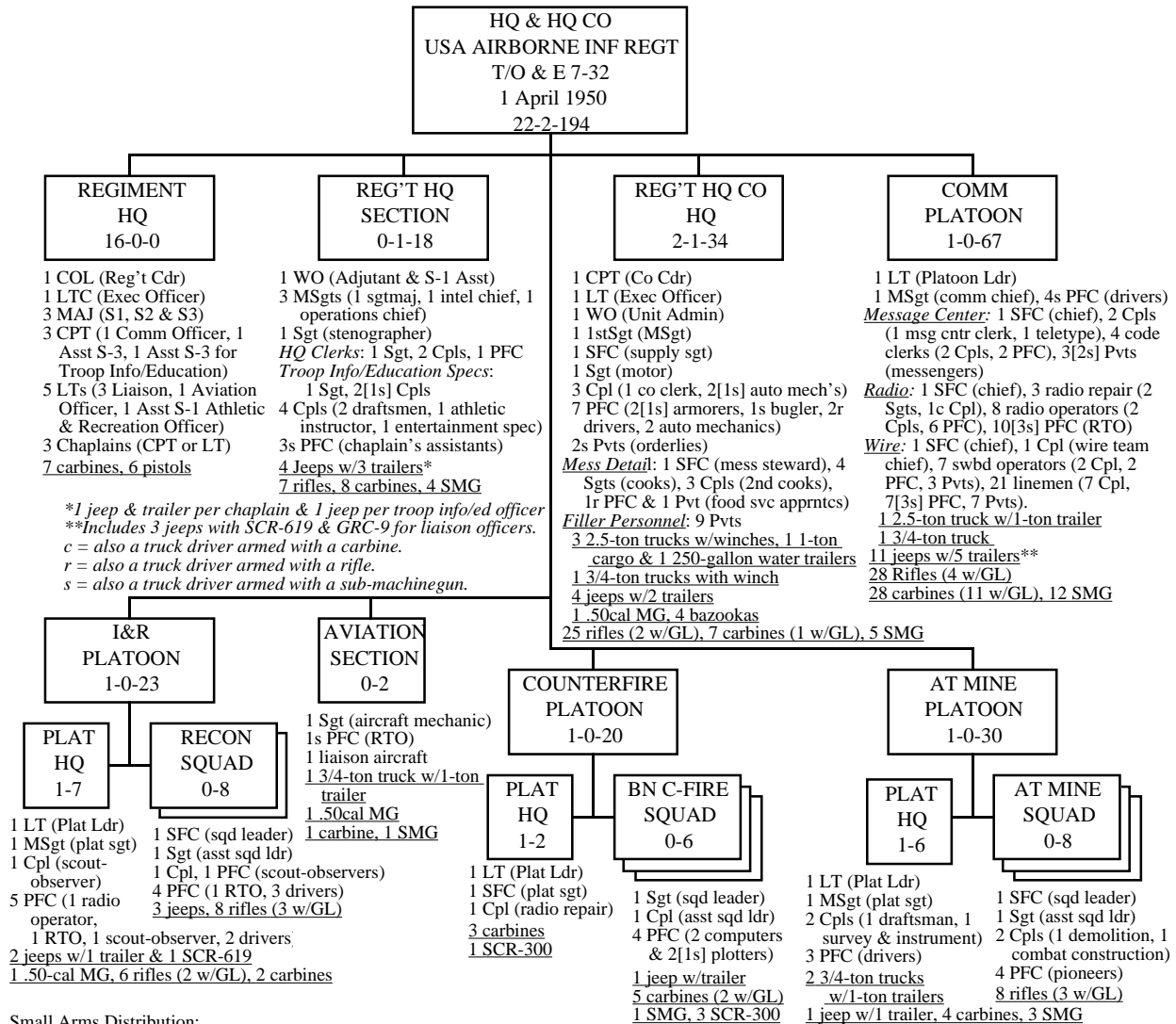

**Small Arms Distribution:**

All field grade officers (colonel, lieutenant colonel, major) and the aviation officer (pilot) armed with pistols. All other officers, warrant officers, first sergeant, master sergeants, sergeants first class (except I&R squad leaders), all counterfire personnel except one drivers, the motor, aircraft maintenance and troop info/education sergeants, all radio repairmen, linemen, the wire team chief, entertainment specialist, athletic instructor, the draftsman and survey specialists in the mine platoon and orderlies and messengers not also serving as drivers carry carbines. All drivers (including additional duty) of jeeps and 3/4-ton trucks armed with sub-machineguns (SMG). All others carry rifles. In addition, Company headquarters holds 166 spare pistols for issue to all jump qualified personnel not already so equipped.

**Notes:**

Non airborne-qualified personnel would include the warrant officer unit administrator, all members of the mess detail, the aviation section, all (or most) drivers not in the I&R platoon and probably certain support personnel such as the troop information and education officer, athletic and recreation officer, etc.

**Source:** Department of the Army Table of Organization 7-32 "Headquarters and Headquarters Company, Infantry Regiment, Airborne" (Washington DC 1 April 1950).

## Appendix 7.14

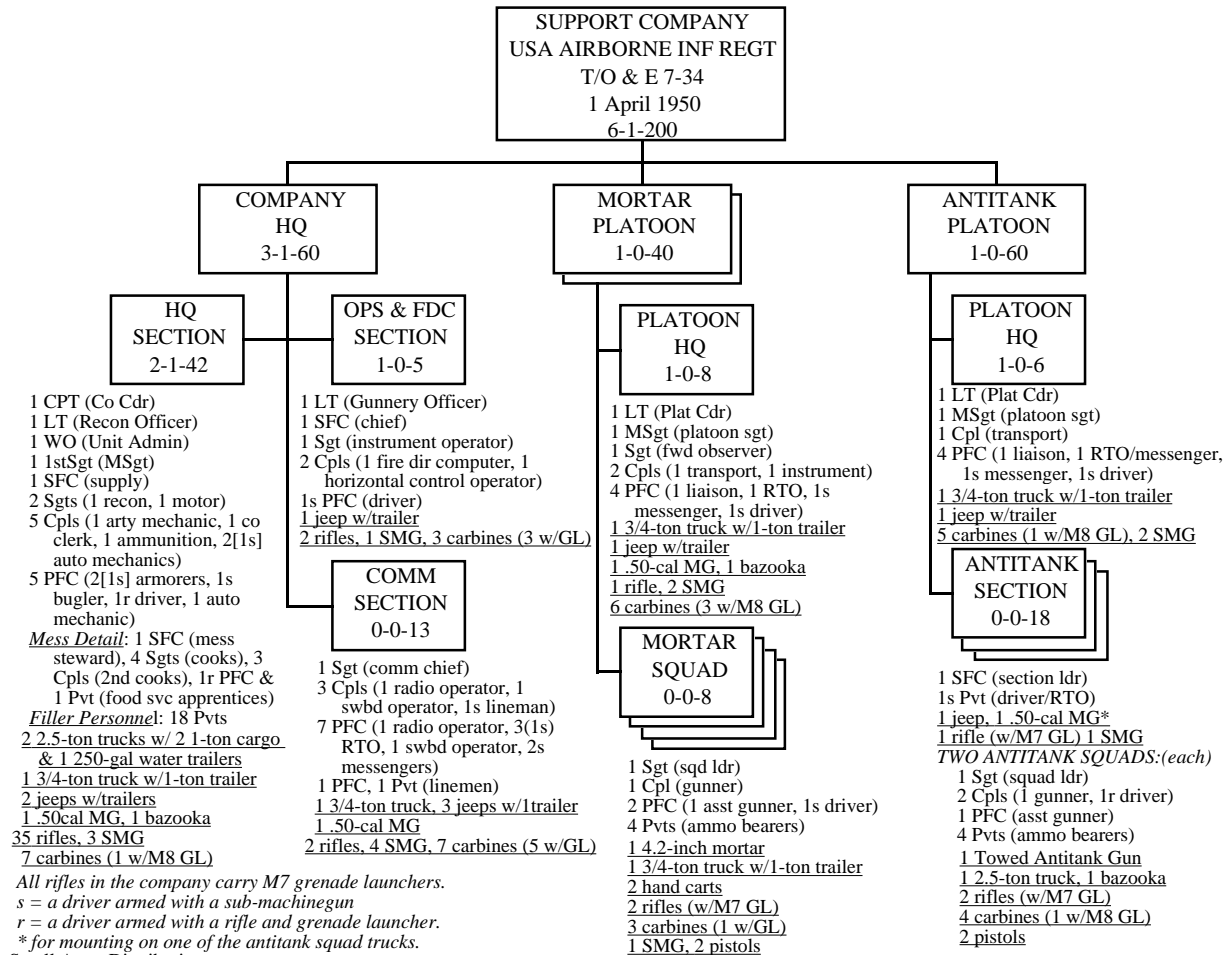

**Notes:**

Non airborne-qualified personnel would include the warrant officer unit administrator, all members of the mess detail, probably all members of the antitank platoon, the motor sergeant and transport corporals and all full-time and some part-time drivers.

**Source:** Department of the Army Table of Organization 7-34 "Support Company, Infantry Regiment, Airborne" (Washington DC 1 April 1950).

Appendix 7.15

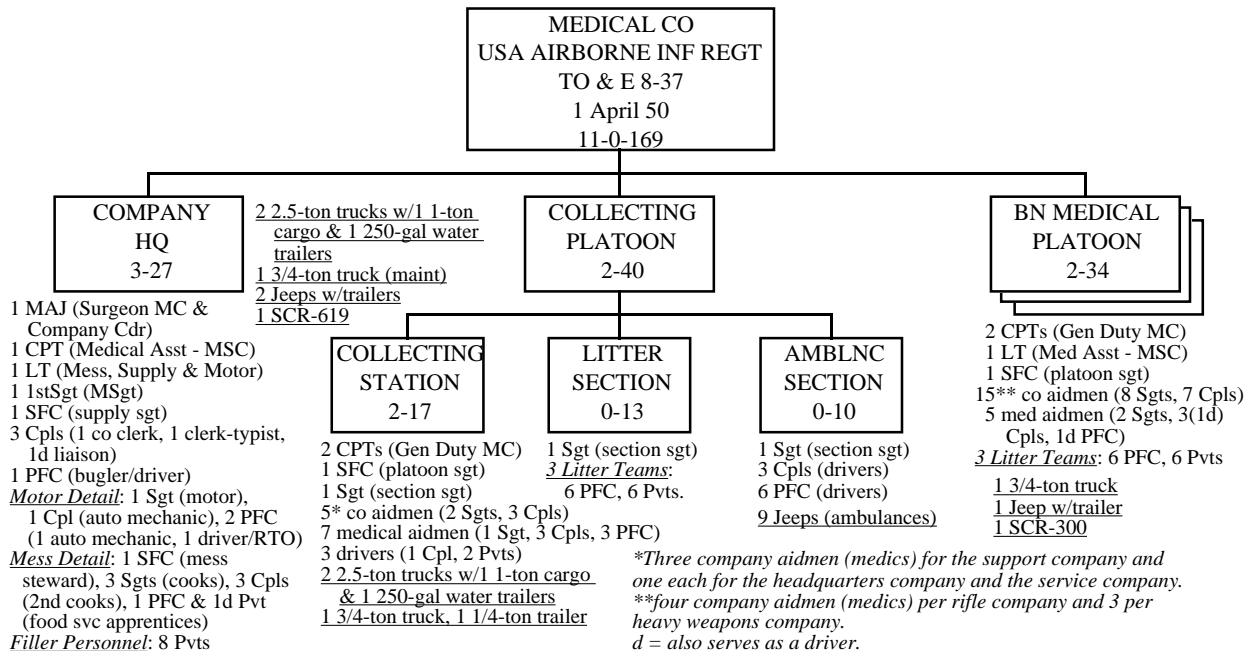
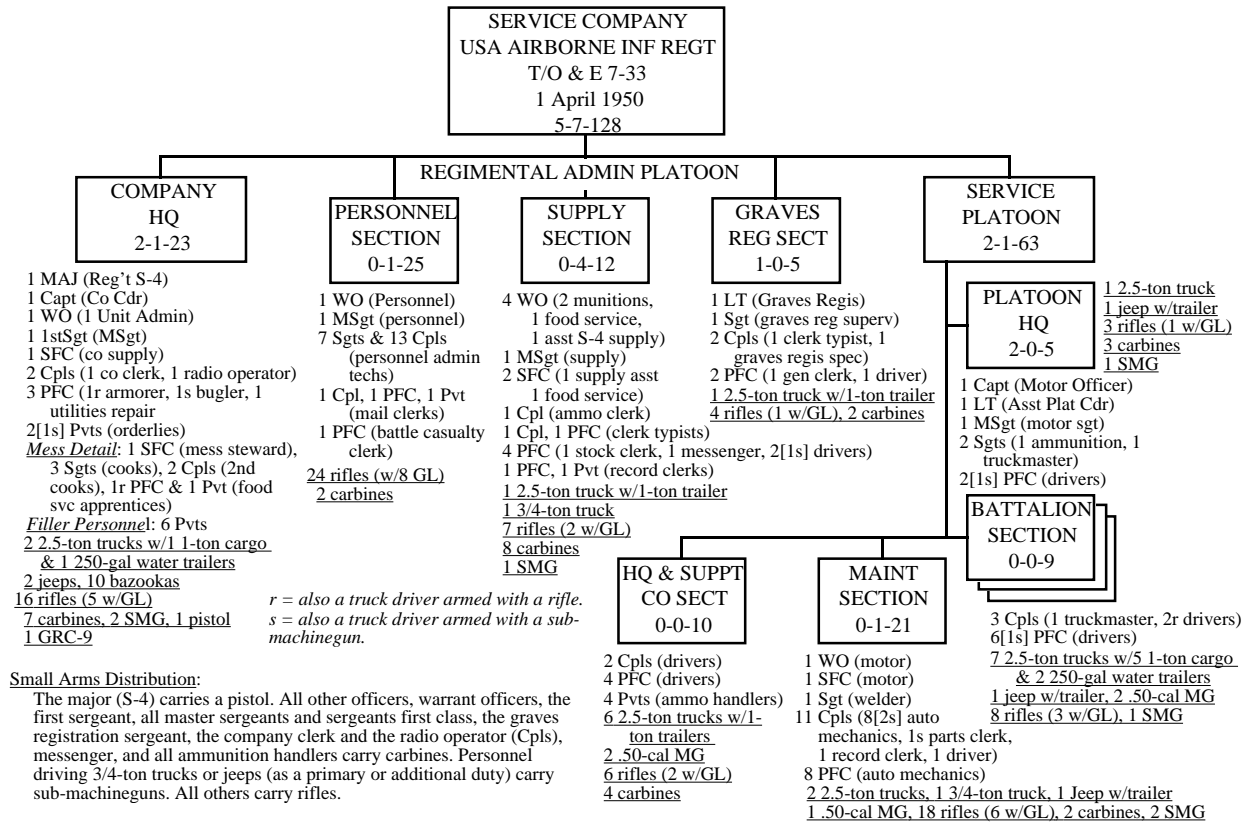

Notes:

The airborne infantry regiment service company was not a parachute capable unit. The medical company was jump capable except for the members of motor detail and mess detail and probably its ambulance section and all (or most) of its drivers.

Source: Department of the Army Tables of Organization 7-33 "Service Company, Infantry Regiment, Airborne" and 8-37 "Medical Company, Infantry Regiment, Airborne" (Washington DC 1 April 1950).

## Appendix 7.16

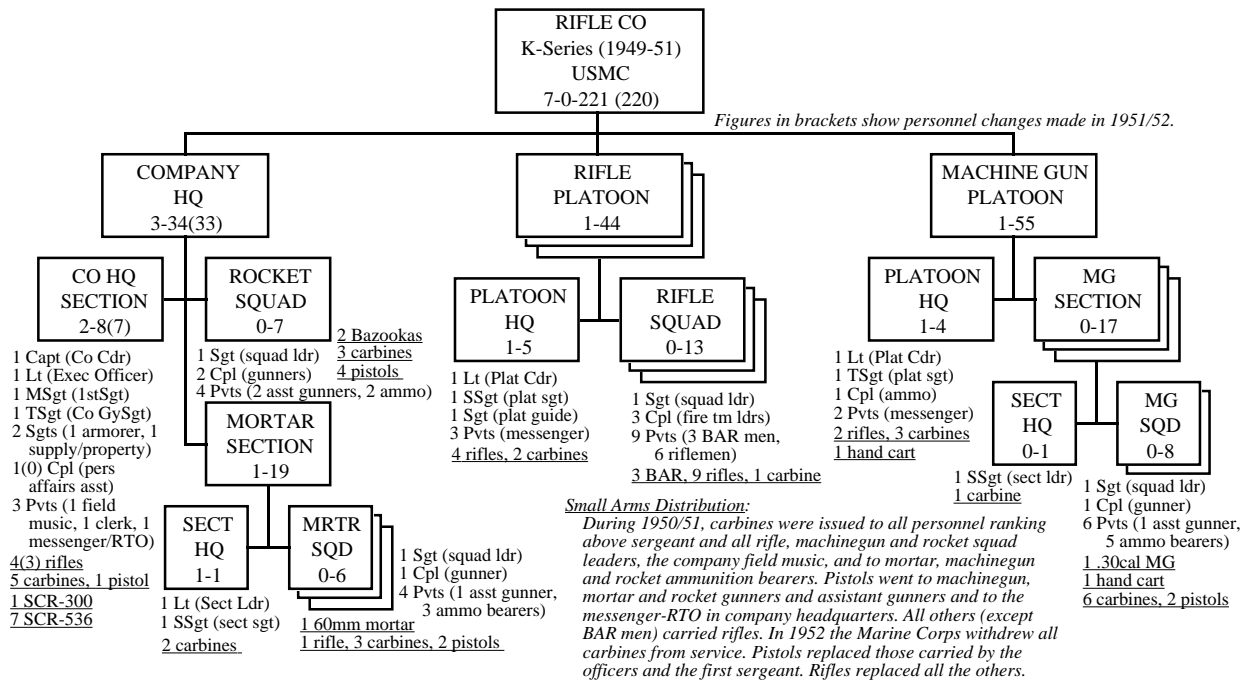

**Notes:**

In early 1952 Headquarters Marine Corps in Change 10 or 11 to these tables eliminated the Doolittle-mandated corporal personal affairs from company headquarters.

**Enlisted Ranks:** The K-Series tables incorporated the Marine Corps' new enlisted rank system but this was much less a change than the Army's new rank system was. The Marine system retained the same basic rank titles as the old system through the grade of sergeant. The ranks of "staff sergeant," "technical sergeant" and "master sergeant" replaced "platoon sergeant," "gunnery sergeant" and "first sergeant" or "sergeant major" respectively in the pay grades of E-5, E-6 and E-7. Under the old system only specialists had held these rank titles. The new system also got rid of all the specialist titles and, like the Army system reversed the pay grade number so that E-1 represented the lowest rank and E-7 the highest, instead of the other way round. Only a few rank increases occurred under the new system. In the rifle company the Marine Corps followed the Army's lead in placing LMG and 60mm mortar squads under sergeants and making corporals the mortar or LMG gunners. Staff sergeants also replaced sergeants as chiefs of mortar and LMG sections. Company armorers (small arms mechanics) became sergeants (E-4) rather than corporals. Despite the importance and challenges of his job the rifle squad leader did not get a rank increase under the K Series tables. This would almost certainly have mandated the promotion of the fire team leaders to sergeant and led to the same difficulties that the Army was experiencing in turning its corporals into what amounted to senior privates.

**Source:** Marine Corps Table of Organization K-1013 "Rifle Company, Infantry Battalion, Infantry Regiment Marine Division, FMF" (HQMC Washington DC 31 May 1949 with Change #10 29 December 1951) with Table of Equipment K-1013 dated 1 August 1950.



Appendix 7.17

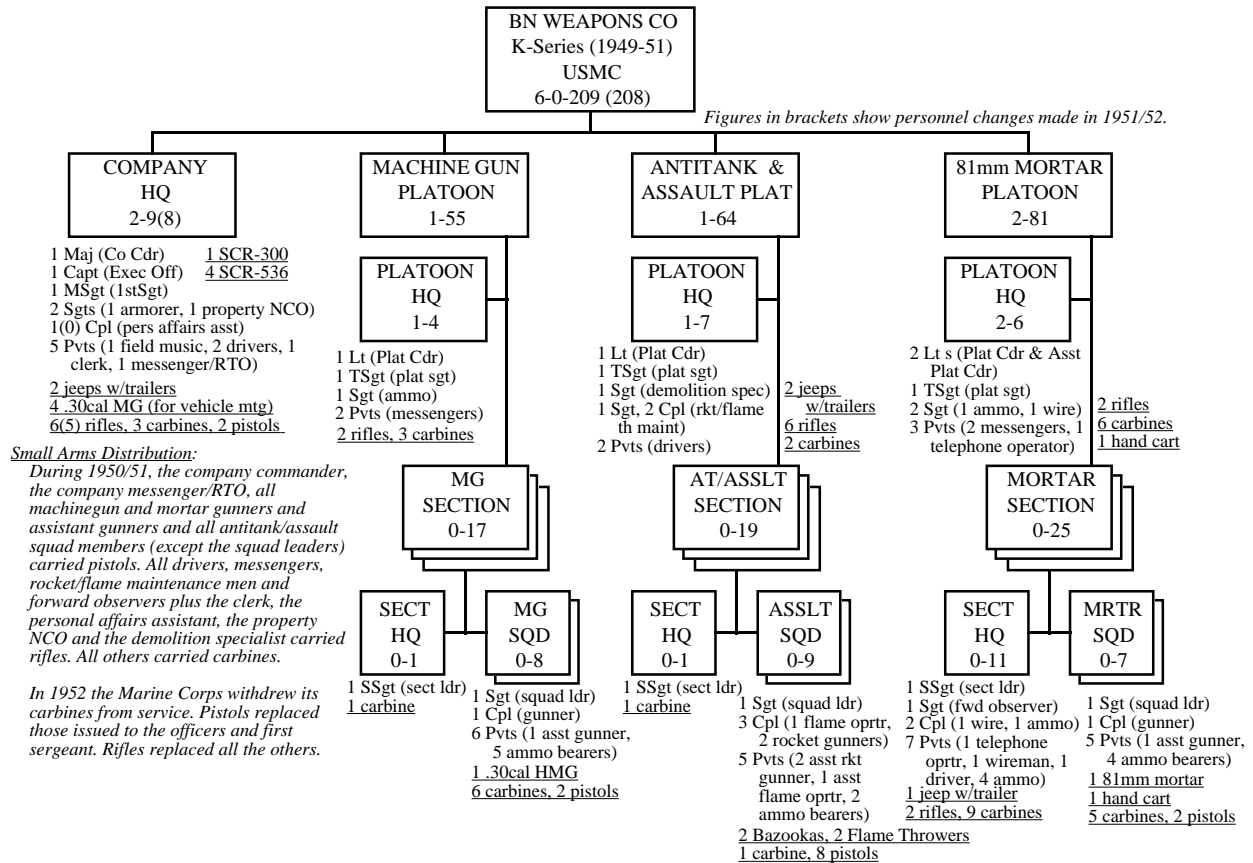

Notes:

In early 1952 Headquarters Marine Corps in Change 10 or 11 to these tables eliminated the Doolittle-mandated corporal personal affairs from company headquarters.

**Enlisted Ranks:** The K-Series tables incorporated the Marine Corps' new enlisted rank system, which is described in the notes to Appendix 7.16. Some rank increases occurred under the new system. In the battalion weapons company the Marine Corps followed the Army's lead in placing machinegun, 81mm mortar and assault squads under sergeants and making corporals the gunners. Staff sergeants also replaced sergeants as machinegun and assault section chiefs. Company armorers (small arms mechanics) became sergeants (E-4) rather than corporals.

**Source:** Marine Corps Table of Organization K-1023 "Weapons Company, Infantry Battalion, Infantry Regiment Marine Division, FMF" (HQMC Washington DC 31 May 1949 with Change #10 29 December 1951) with Table of Equipment K-1023 dated 1 August 1950.

## Appendix 7.18

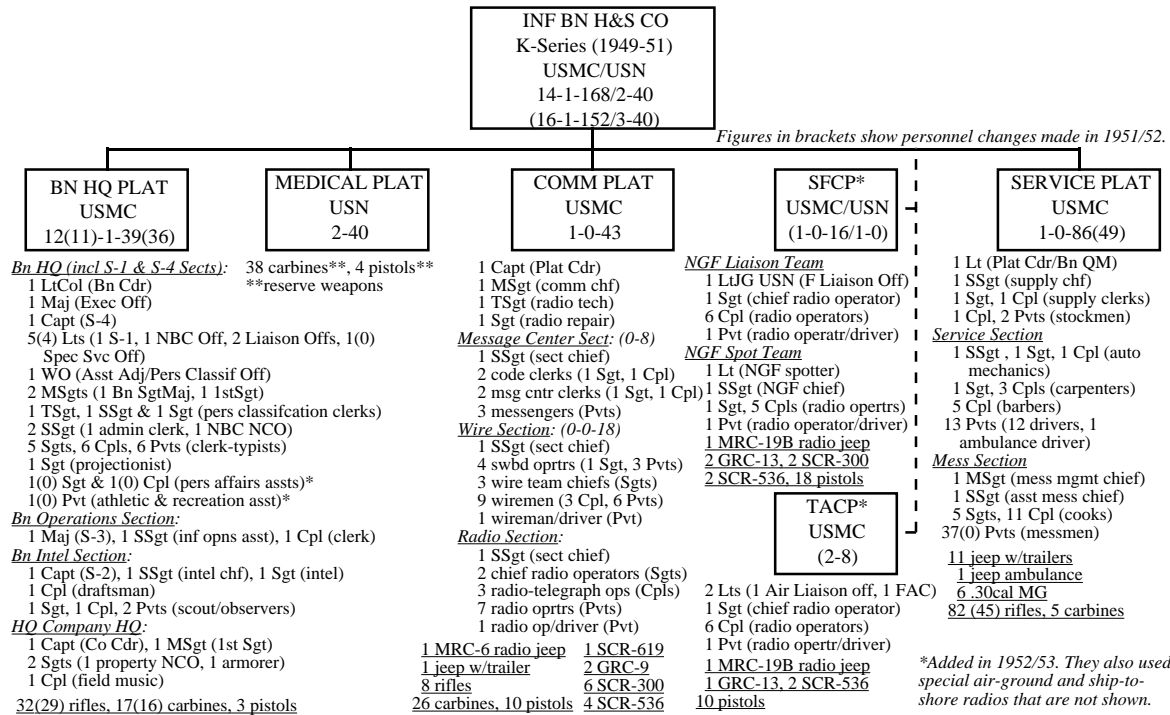

**Small Arms Distribution:**

*During 1950/51 all personnel ranking from captain to staff sergeant plus the company field music and all personnel in the wire section and to radio-telegraph operators carried carbines. All other radio operators and the major and the lieutenant colonel received pistols. All others carried rifles. In 1952 the Marine Corps withdrew its carbines from service. Pistols replaced those issued to the officers, the sergeant major, the first sergeant and all medical personnel. Rifles replaced all the others.*

**Notes:**

In early 1952 Headquarters Marine Corps in Change 10 or 11 to these tables eliminated the Doolittle-mandated health and welfare personnel, including a lieutenant special services officer, two personal affairs assistants (a sergeant for the battalion and a corporal for the H&S company) and an athletic and recreation assistant (private).

**Shore Fire Control Party (SFCP) and Tactical Air Control Party (TACP):** These elements were attached to the battalion from the division signal battalion to direct naval gunfire and air strikes, respectively. Each had a liaison officer a forward observer or air controller and a number of radio operators. After the breakup of the division signal battalion in 1952 the SFCP and TACP became organic elements of the battalions that they supported.

**Navy Medical:** This detachment was now carried as a platoon under a medical corps (MC) lieutenant, assisted by a lieutenant (j.g.) (MC). The senior enlisted men were two chief hospital men (HMC), whose rank was equivalent to a master sergeant (E-7). These two and the two officers could carry pistols when authorized. The other members of the platoon would carry carbines. They included five hospital men 1<sup>st</sup> Class (HM1 or E-6), seven hospital men 2<sup>nd</sup> Class (HM2 or E-5), 10 hospital men 3<sup>rd</sup> Class (HM3 or E-4), 10 hospital men (HN or E-3) and six hospital apprentices (HA or E-2).

**Personnel Administration:** As under the F and G series tables the battalion headquarters handled personnel administration for the entire battalion. Three personnel classification clerks (a technical sergeant, a staff sergeant and a sergeant) carried this out, assisted by a staff sergeant (admin clerk) and a pool of 17 clerk typists who also supported the other staff sections.

**Enlisted Ranks:** The K-Series tables incorporated the Marine Corps' new enlisted rank system, which is described in the notes to Appendix 7.16. Some rank increases occurred under the new system.

**Source:** Marine Corps Table of Organization K-1037 "Headquarters and Service Company, Infantry Battalion, Infantry Regiment Marine Division, FMF" (HQMC Washington DC 31 May 1949 with Change #10 29 December 1951) with Table of Equipment K-1037 dated 1 August 1950.

Appendix 7.19

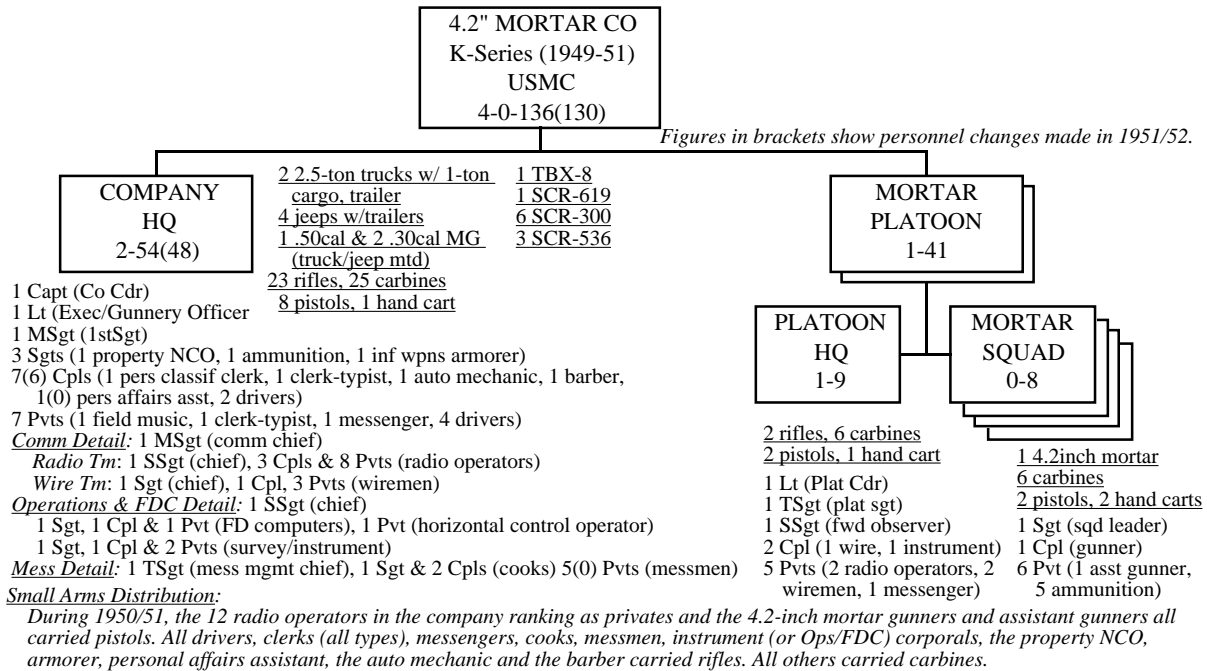

Notes:

In early 1952 Headquarters Marine Corps in Change 10 or 11 to these tables eliminated the Doolittle-mandated corporal personal affairs from company headquarters and the five privates (messmen) from the company mess detail. Since this company was not part of a battalion it handled its own administration, mess and supply.

Source: Marine Corps Table of Organization K-1083 "4.2-inch Mortar Company, Infantry Regiment Marine Division, FMF" (HQMC Washington DC 31 May 1949 with Change #10 29 December 1951) with Table of Equipment K-1083 dated 1 August 1950.

## Appendix 7.20

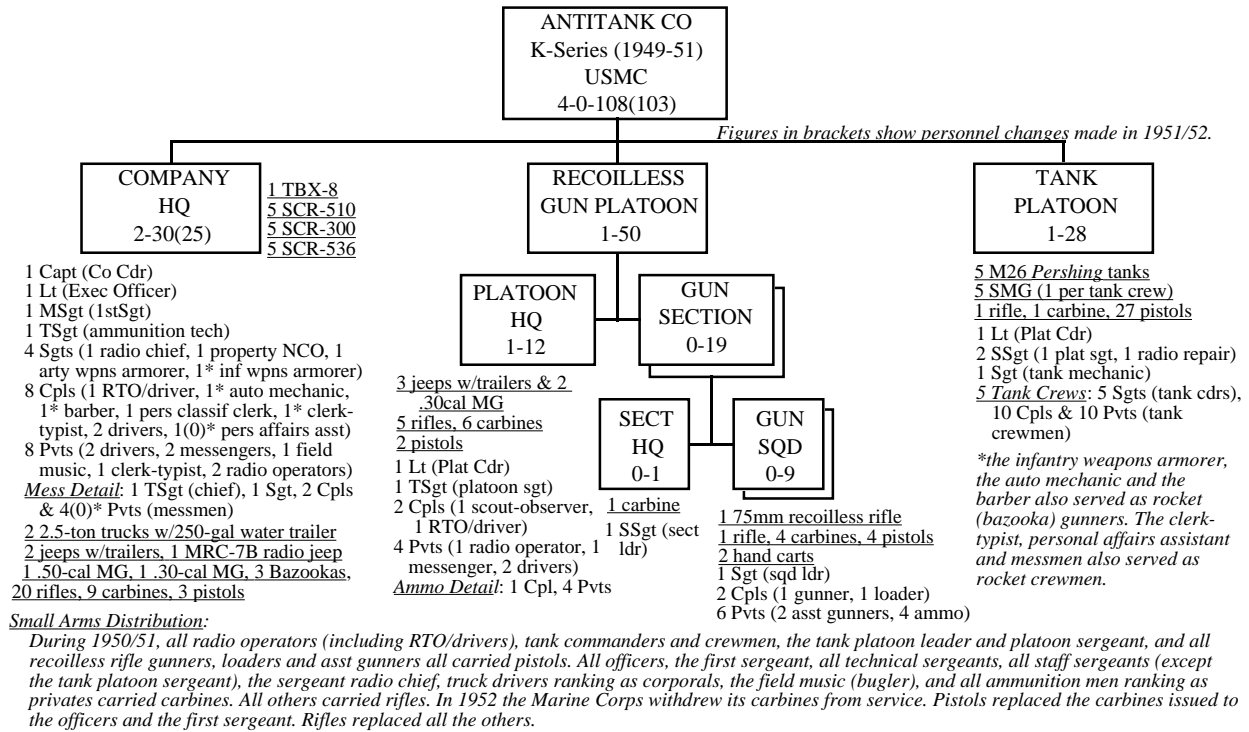

**Notes:**

In early 1952 Headquarters Marine Corps in Change 10 or 11 to these tables eliminated the Doolittle-mandated corporal personal affairs from company headquarters and the four privates (messmen) from the company mess detail. Since this company was not part of a battalion it handled its own administration, mess and supply.

**Source:** Marine Corps Table of Organization K-1073 "Anti-Tank Company, Infantry Regiment Marine Division, FMF" (HQMC Washington DC 31 May 1949 with Change #10 29 December 1951) with Table of Equipment K-1073 dated 1 August 1950.

Appendix 7.21

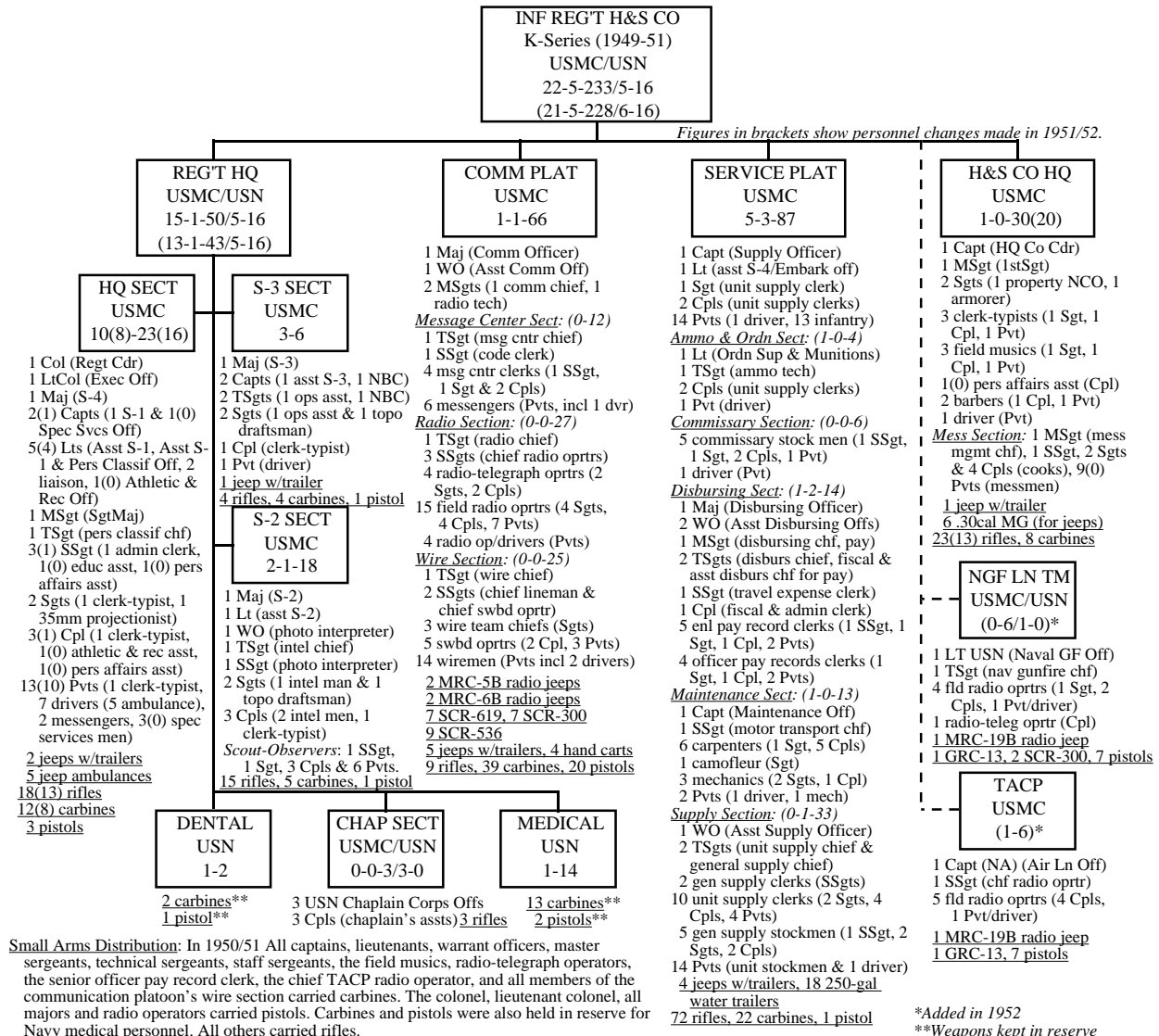

**Small Arms Distribution:** In 1950/51 All captains, lieutenants, warrant officers, master sergeants, technical sergeants, staff sergeants, the field musics, radio-telegraph operators, the senior officer pay record clerk, the chief TACP radio operator, and all members of the communication platoon's wire section carried carbines. The colonel, lieutenant colonel, all majors and radio operators carried pistols. Carbines and pistols were also held in reserve for Navy medical personnel. All others carried rifles.

**Notes:**

In early 1952 Headquarters Marine Corps in Change 10 or 11 to these tables eliminated the Doolittle-mandated health and welfare personnel from regimental headquarters and the headquarters and service company headquarters. These included a captain special services officer, a lieutenant athletic and recreation officer, a staff sergeant education assistant, two personal affairs assistants (a staff sergeant in regimental headquarters and a corporal in company headquarters), an athletic and recreation assistant (corporal) and three basic special services men (privates). Also eliminated were the nine privates (messmen) from the company mess detail.

**Naval Gunfire Liaison Team and Tactical Air Control Party (TACP):** These elements were attached to the battalion from the division signal battalion to coordinate naval gunfire and air strikes, respectively. Each was a liaison team only. It could direct strikes if required, though at the expense of its liaison mission. After the breakup of the division signal battalion in 1952 the SFCP and TACP became organic elements of the battalions that they supported.

**Navy Medical:** This detachment now served as a section under a medical corps (MC) lieutenant commander. This officer and the chief hospital man (HMC or E-7) could carry pistols when authorized. The other members of the section could carry carbines. They included seven hospital men 1<sup>st</sup> Class (HM1 or E-6), four hospital men 2<sup>nd</sup> Class (HM2 or E-5) and two hospital men 3<sup>rd</sup> Class (HM3 or E-4). Five HM1 from this section would serve as medics for the antitank and heavy mortar companies, probably three with the antitank company and two with the mortars.

**Enlisted Ranks:** The K-Series tables incorporated the Marine Corps' new enlisted rank system, which is described in the notes to Appendix 7.16. Some rank increases occurred under the new system.

**Source:** Marine Corps Table of Organization K-1097 "Headquarters and Service Company, Infantry Regiment Marine Division, FMF" (HQMC Washington DC 31 May 1949 with Change #10 29 December 1951) with Table of Equipment K-1097 dated 1 August 1950.

\*Added in 1952  
\*\*Weapons kept in reserve

Appendix 7.22

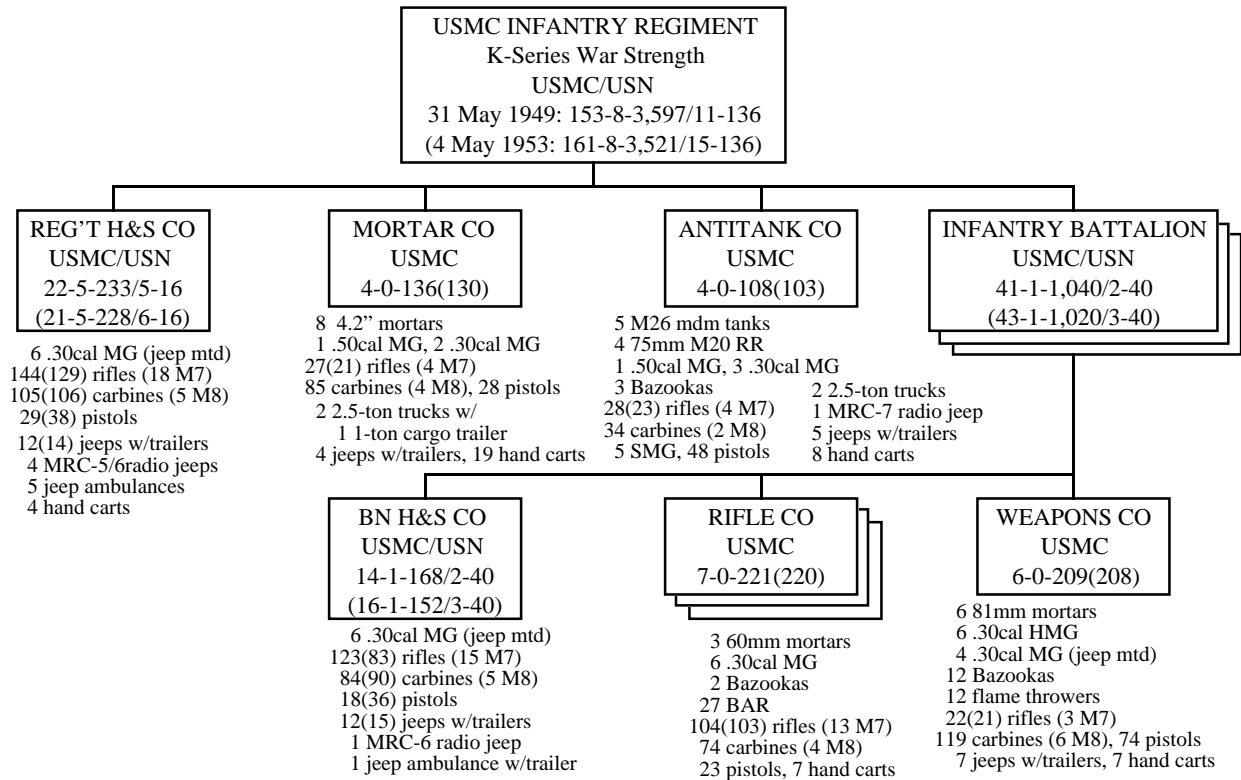

Notes:

Source: Marine Corps Table of Organization K-1099 "Infantry Regiment Marine Division, FMF" (HQMC Washington DC 31 May 1949 with Change #10 29 December 1951) with accompanying Tables of Equipment dated 1 August 1950.

Appendix 7.23

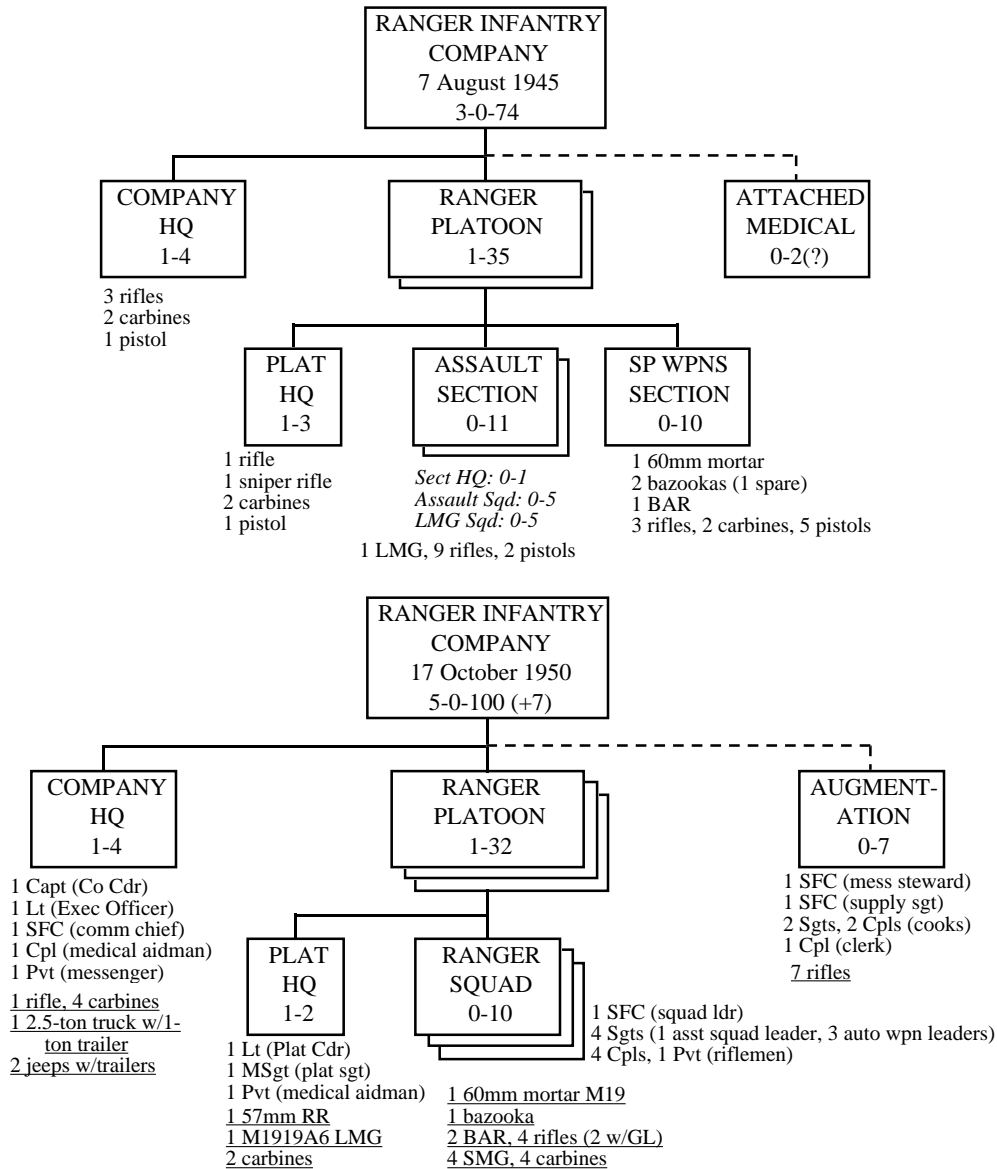

Notes:

In the 1950 company each Ranger squad had a pool of weapons from which it could vary its armament to suit its mission. Platoon headquarters could supply an LMG and a recoilless rifle if the squads required them.

Sources: War Department Table of Organization 7-87 "Ranger Company, Ranger Infantry Battalion" (Washington DC 7 August 1945) and Department of the Army Table of Organization 7-87 "Ranger Infantry Company (Airborne) (Tentative)" (Washington DC 17 October 1950).

# APPENDIX 8

## Appendix 8.1

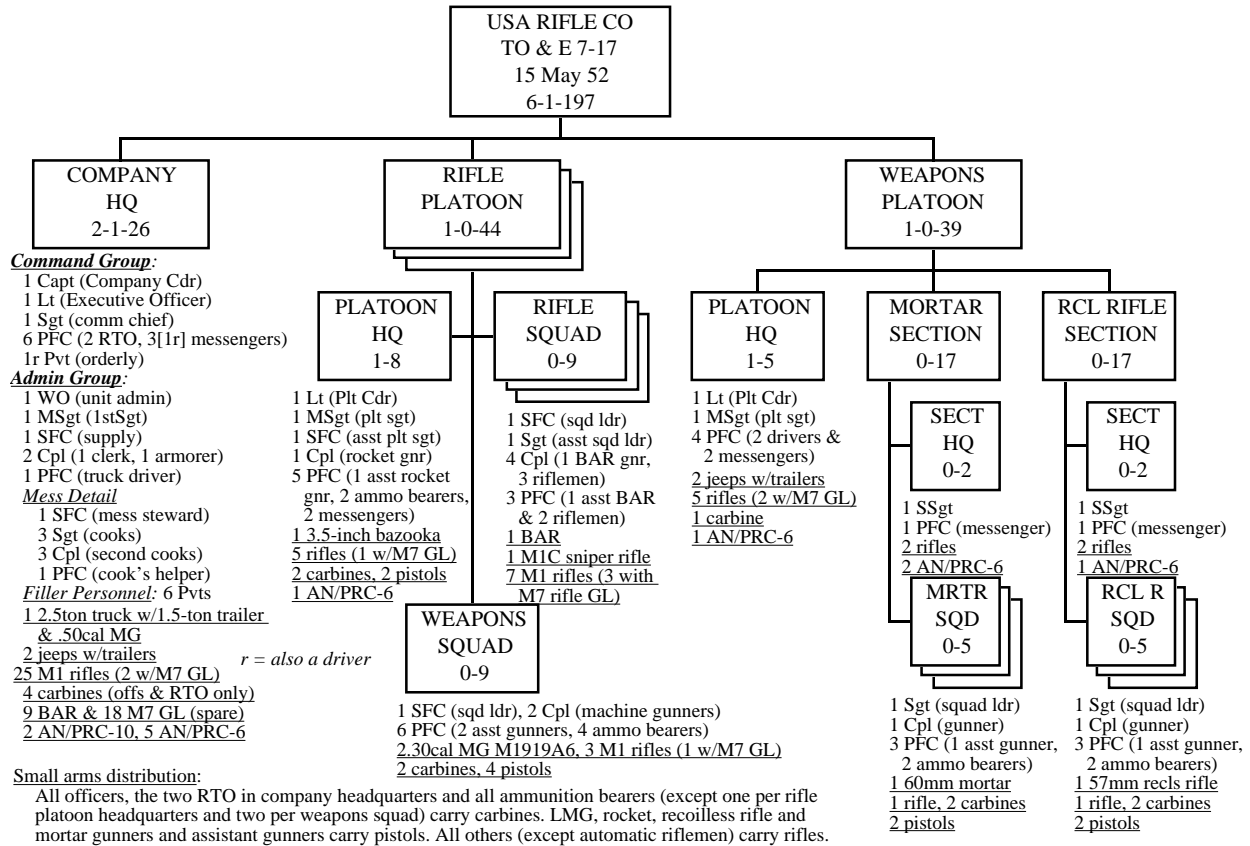

**Notes:**

**Radio Equipment:** Towards the end of the Korean War the Army began to replace its World War II era man-packed SCR-300 voice radios with (for the infantry) the AN/PRC-10. The new hand-held radio (replacing the SCR-536) was the AN/PRC-6.

**Source:** Department of the Army Table of Organization 7-17 "Infantry Rifle Company" (Washington DC 15 May 1952).



## Appendix 8.2

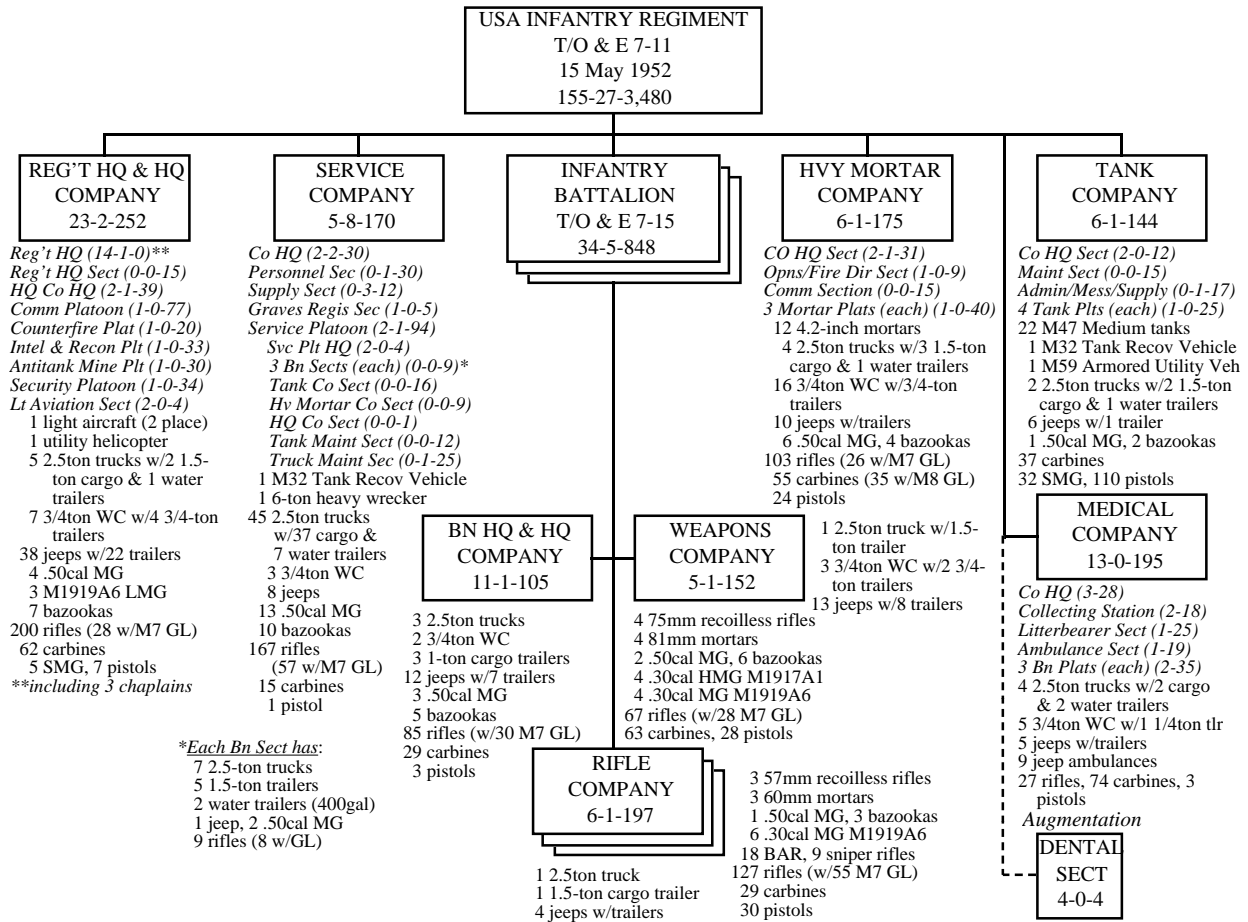

**Notes:**

The battalion headquarters company and weapons company had changed very little since the November 1950 tables (see Appendices 7.2 and 7.3). Most changes were minor personnel economies such as the elimination of most dedicated jeep drivers and messengers acting as drivers as an additional duty. Companies were also limited to one armorer (weapons repair man) and (except in the rifle companies where there was a large reduction) there were small reductions in filler personnel. The dental section is included only if the infantry regiment is not part of an infantry division.

**Source:** Department of the Army Tables of Organization 7-15 "Infantry Battalion, Infantry Regiment;" 7-14 "Heavy Mortar Company, Infantry Regiment;" 17-37 "Tank Company;" 7-13 "Service Company, Infantry Regiment;" 8-7 "Medical Company, Infantry Regiment;" and 7-12 "Headquarters and Headquarters Company, Infantry Regiment" (Washington DC 15 May 1952).

Appendix 8.3

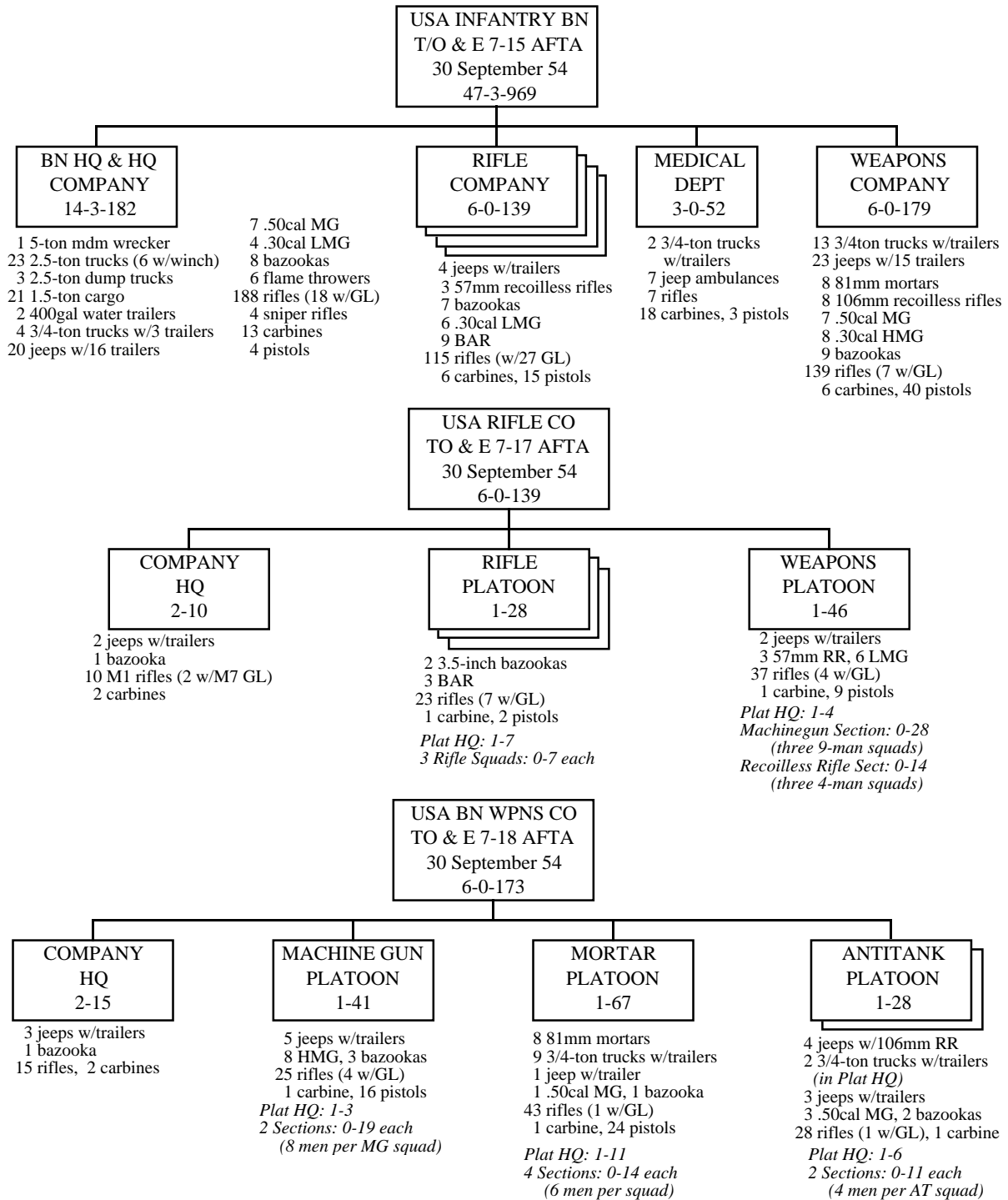

**Appendix 8.3 (continued)**

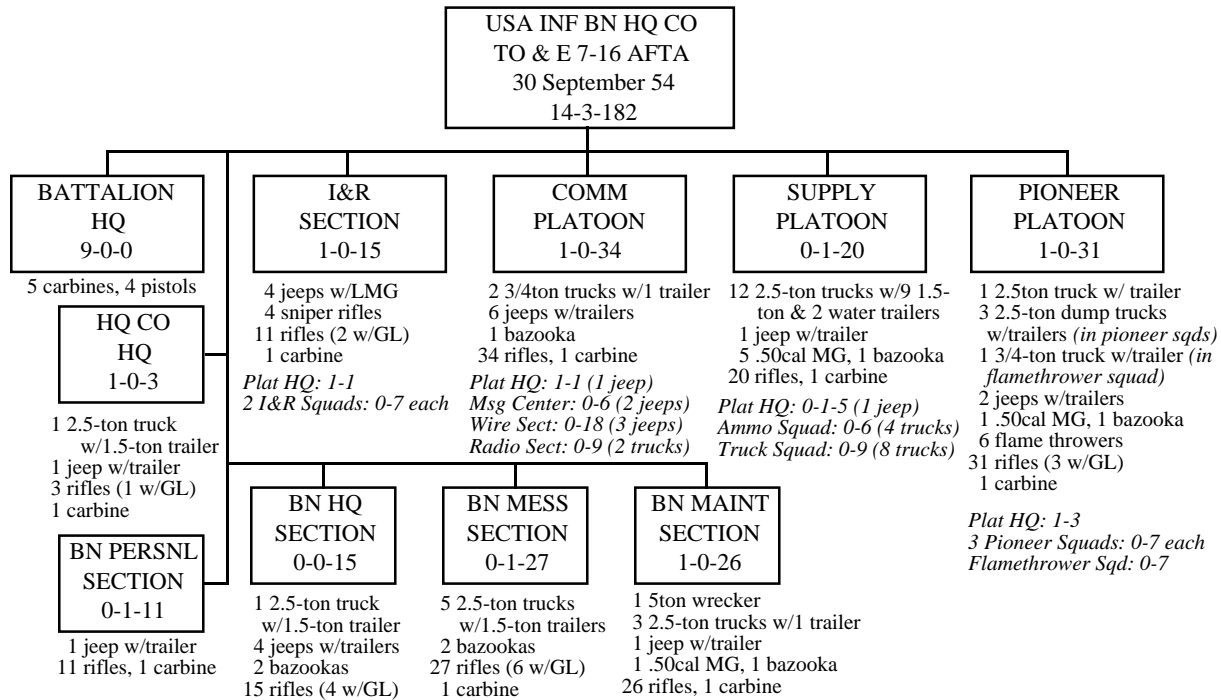

**Notes:**

**Battalion headquarters:** Battalion commander (lieutenant colonel), executive officer (major), operations-intelligence officer (major), logistics-adjutant officer (major), assistant intelligence officer (captain), assistant operations officer (captain), assistant adjutant or S1 (captain), assistant logistics officer (captain), and a liaison officer (lieutenant).

**Headquarters Company Headquarters:** Company commander (captain), first sergeant (master sergeant), assistant supply sergeant (sergeant) and one light truck driver (private E-2).

**Rifle Company Headquarters:** Company Commander (captain), executive officer (lieutenant), first sergeant (master sergeant), assistant supply sergeant (and rocket launcher gunner) (sergeant), communication chief (sergeant), three wiremen (one corporal and two PFC), two radio telephone operators (PFC), one messenger/light truck driver (PFC) and one light truck driver (private).

**Weapons Company Headquarters:** Company Commander (captain), executive officer (lieutenant), first sergeant (master sergeant), assistant supply sergeant (and rocket launcher gunner) (sergeant), communication chief (sergeant), one switchboard operator (corporal), four wiremen (one corporal and three PFC), three radio telephone operators (one is also a driver) (PFC), two messengers (PFC) and two light truck drivers (privates).

**Source:** Department of the Army Tables of Organization 7-15 AFTA "Infantry Battalion;" 7-16 AFTA "Headquarters and Headquarters Company, Infantry Battalion;" 7-17 AFTA "Infantry Rifle Company, Infantry Battalion;" and 7-18 AFTA "Infantry Weapons Company, Infantry Battalion (OCAFF, Fort Monroe Virginia 30 September 1954).

Appendix 8.4

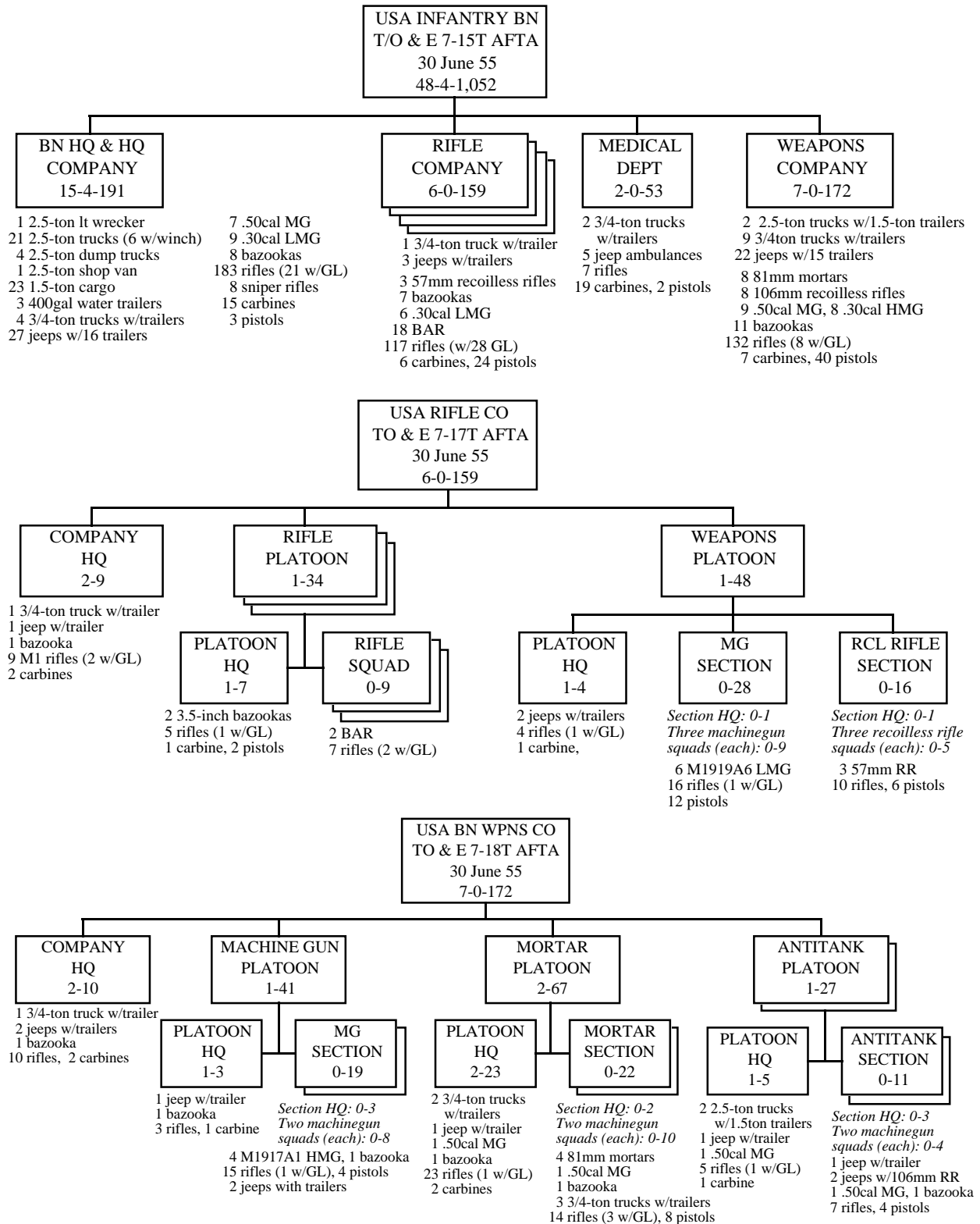

Appendix 8.4 (continued)

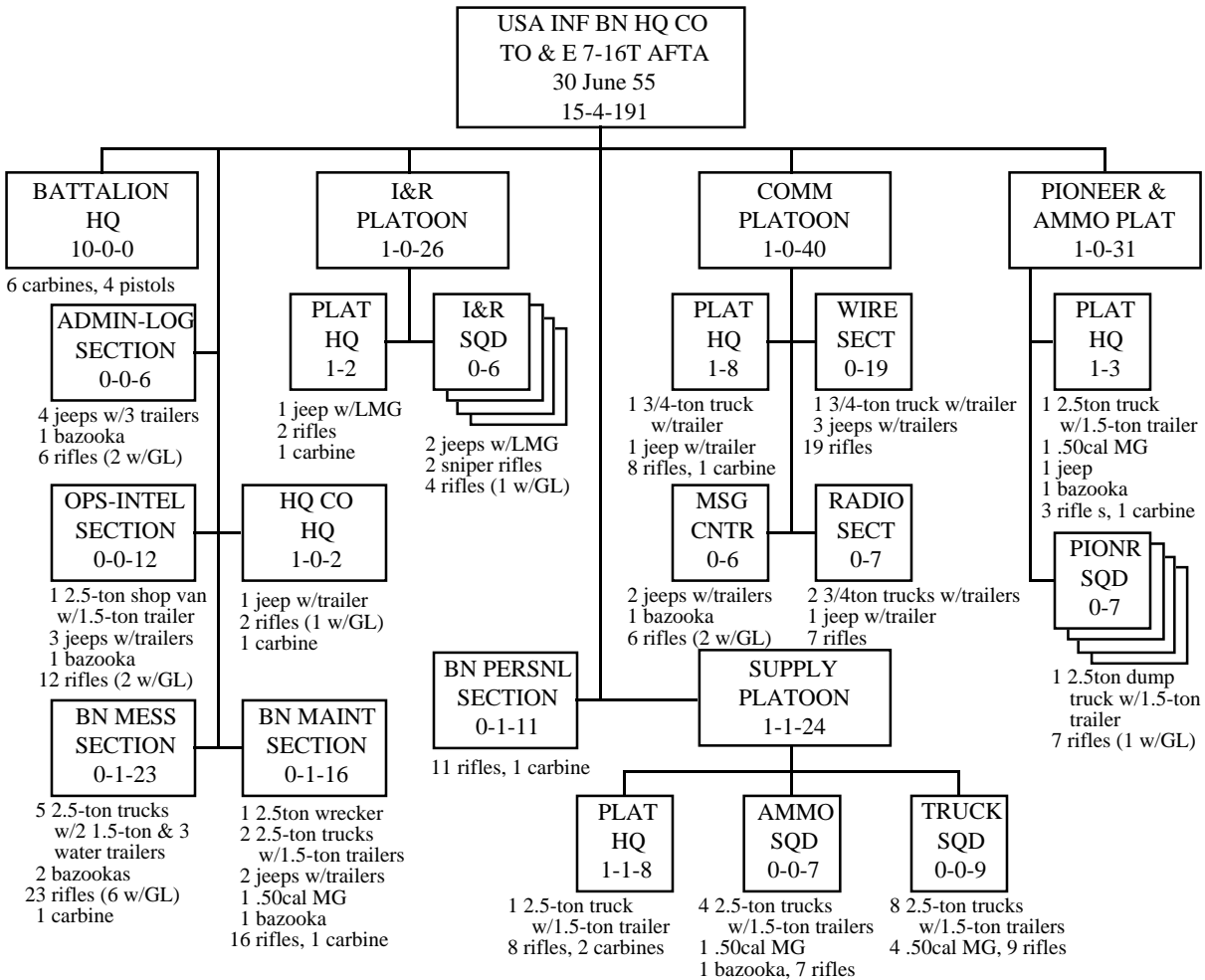

Notes:

**Battalion headquarters:** Battalion commander (lieutenant colonel), executive officer (major), S-3 (major), S-1, S-2, S-4, assistant S-3 for air, a chaplain and a motor officer (all captains) plus a liaison officer (lieutenant).

**Headquarters Company Headquarters:** Company commander (captain), first sergeant (master sergeant), and one light truck driver (private E-2).

**Rifle Company Headquarters:** Company Commander (captain), executive officer (lieutenant), first sergeant (master sergeant), communication chief (sergeant), three wiremen (one corporal [also a driver] and two PFC), three radio telephone operators (PFC – one is also a driver) and one messenger (PFC).

**Weapons Company Headquarters:** Company Commander (captain), executive officer (lieutenant), first sergeant (master sergeant), communication chief (sergeant), one switchboard operator (corporal), two wiremen (PFC – one also a driver), three radio telephone operators (one is also a driver) (PFC) and two messengers (PFC – one also a driver).

**Sources:** Office of the Chief of the Army Field Forces Tentative Tables of Organization 7-15T AFTA “Infantry Battalion;” 7-16T AFTA “Headquarters and Headquarters Company, Infantry Battalion;” 7-17T AFTA “Infantry Rifle Company, Infantry Battalion;” and 7-18T AFTA “Infantry Weapons Company, Infantry Battalion (OCAFF, Fort Monroe Virginia 30 June 1955).

## Appendix 8.5

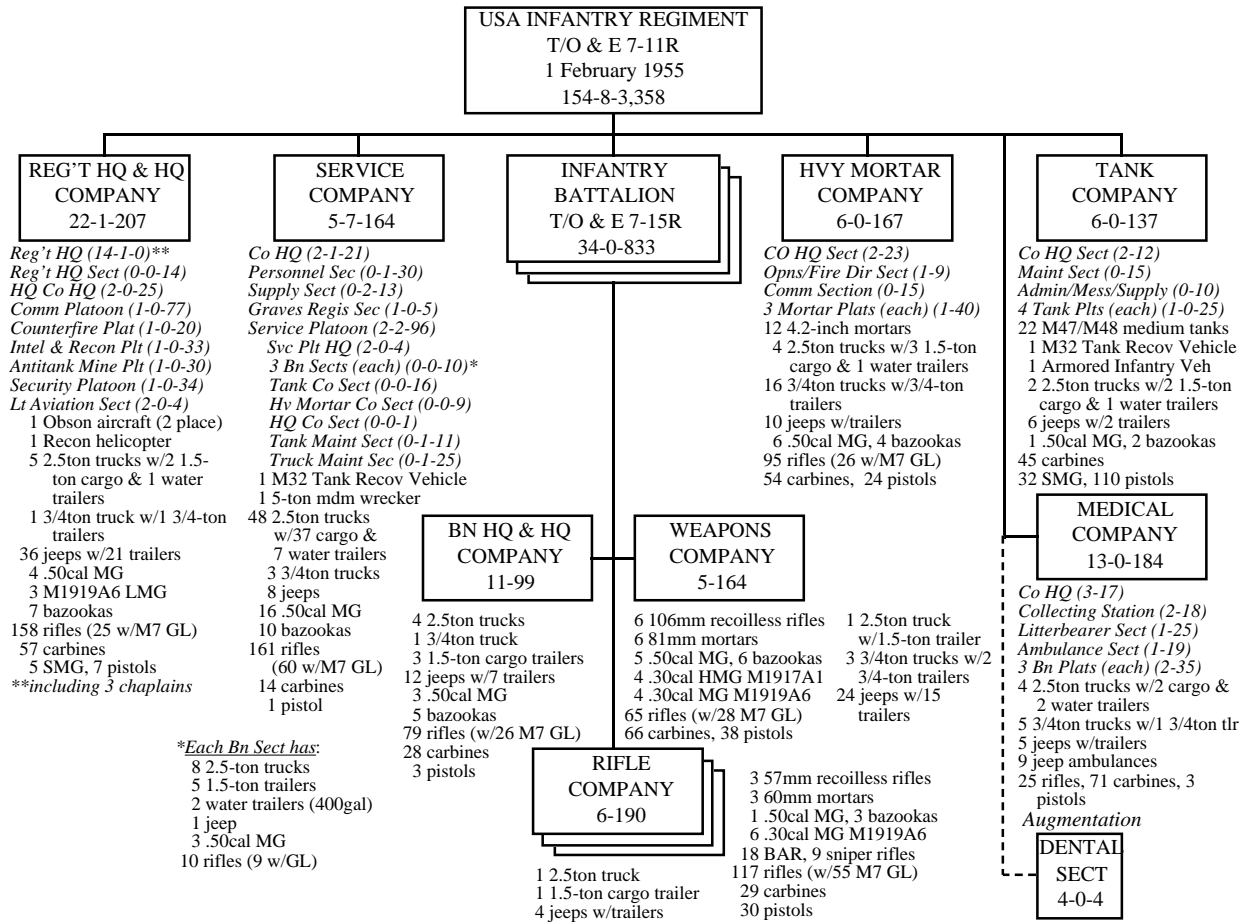

**Notes:**

**Antitank Platoon, Weapons Company (replacing the recoilless rifle platoon or section used earlier):** It has a lieutenant (platoon leader), a master sergeant (platoon sergeant), four PFC (two drivers, one driver/messenger and one RTO), two 3/4-ton trucks with trailers (one also mounting a .50-caliber machinegun), a jeep and trailer and three antitank sections. Each section has a sergeant first class (leader), two PFC (an ammunition handler and a driver), a jeep and trailer and two squads. Each squad has a sergeant (leader), a corporal (gunner), two PFC (a driver and an ammunition bearer) and a jeep with a 106mm recoilless rifle.

**Sources:** Department of the Army Tables of Organization 7-11R "Infantry Regiment;" 7-12R "Headquarters and Headquarters Company, Infantry Regiment;" 7-13R "Service Company, Infantry Regiment;" 7-14R "Heavy Mortar Company, Infantry Regiment;" 17-37R "Tank Company, 120mm Gun or 90mm Gun;" 8-7R "Medical Company, Infantry Regiment;" 7-15R "Infantry Battalion, Infantry Regiment;" 7-16R "Headquarters and Headquarters Company, Infantry Battalion;" 7-17R "Infantry Rifle Company;" and 7-18R "Infantry Weapons Company" (Washington DC 1 February 1955).

Appendix 8.6

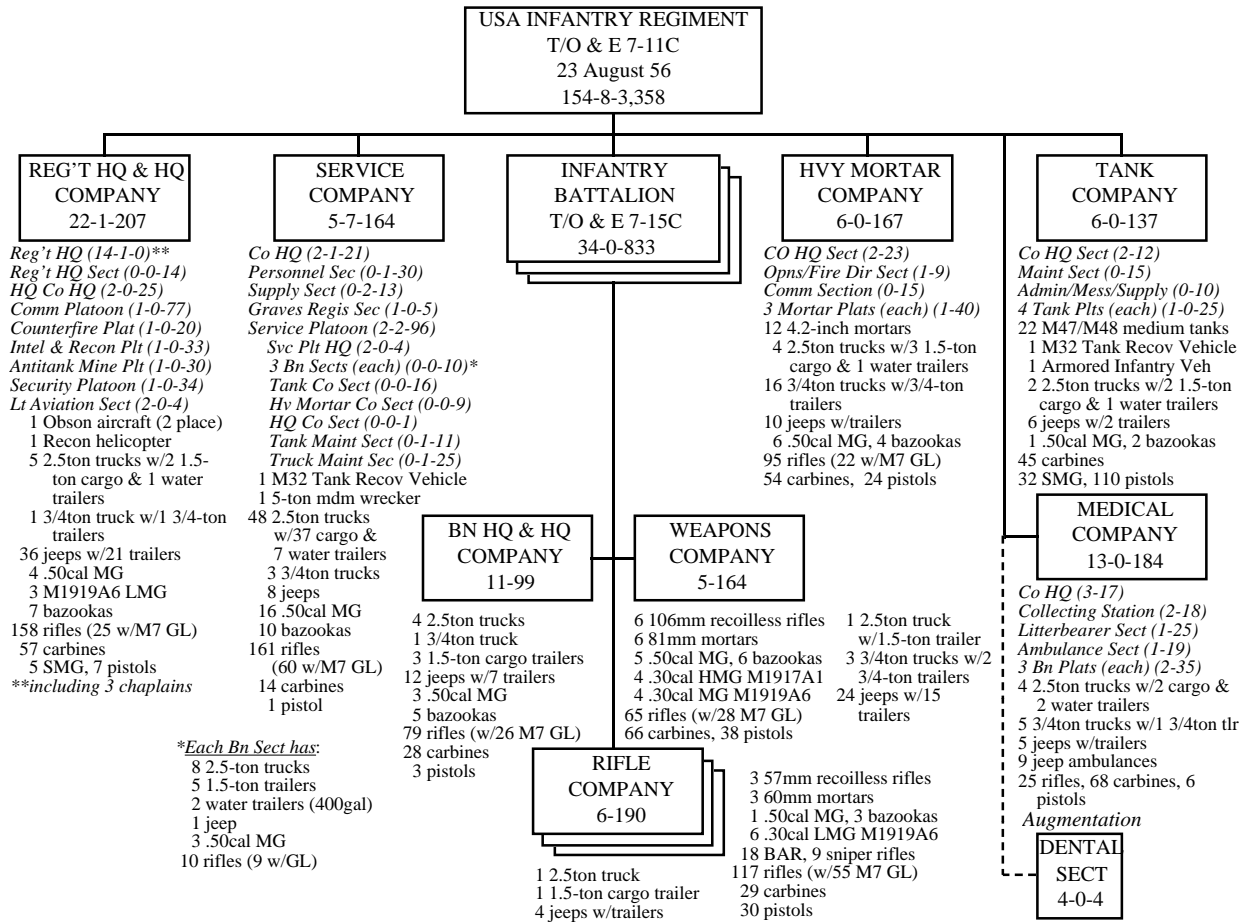

Notes:

Sources: Department of the Army Tables of Organization 7-11C "Infantry Regiment;" 7-12C "Headquarters and Headquarters Company, Infantry Regiment;" 7-13C "Service Company, Infantry Regiment;" 7-14C "Heavy Mortar Company, Infantry Regiment;" 17-37C "Tank Company, 120mm Gun or 90mm Gun;" 8-7C "Medical Company, Infantry Regiment;" 7-15C "Infantry Battalion, Infantry Regiment;" 7-16C "Headquarters and Headquarters Company, Infantry Battalion;" 7-17C "Infantry Rifle Company;" and 7-18C "Infantry Weapons Company" (Washington DC 23 August 1955).

Appendix 8.7

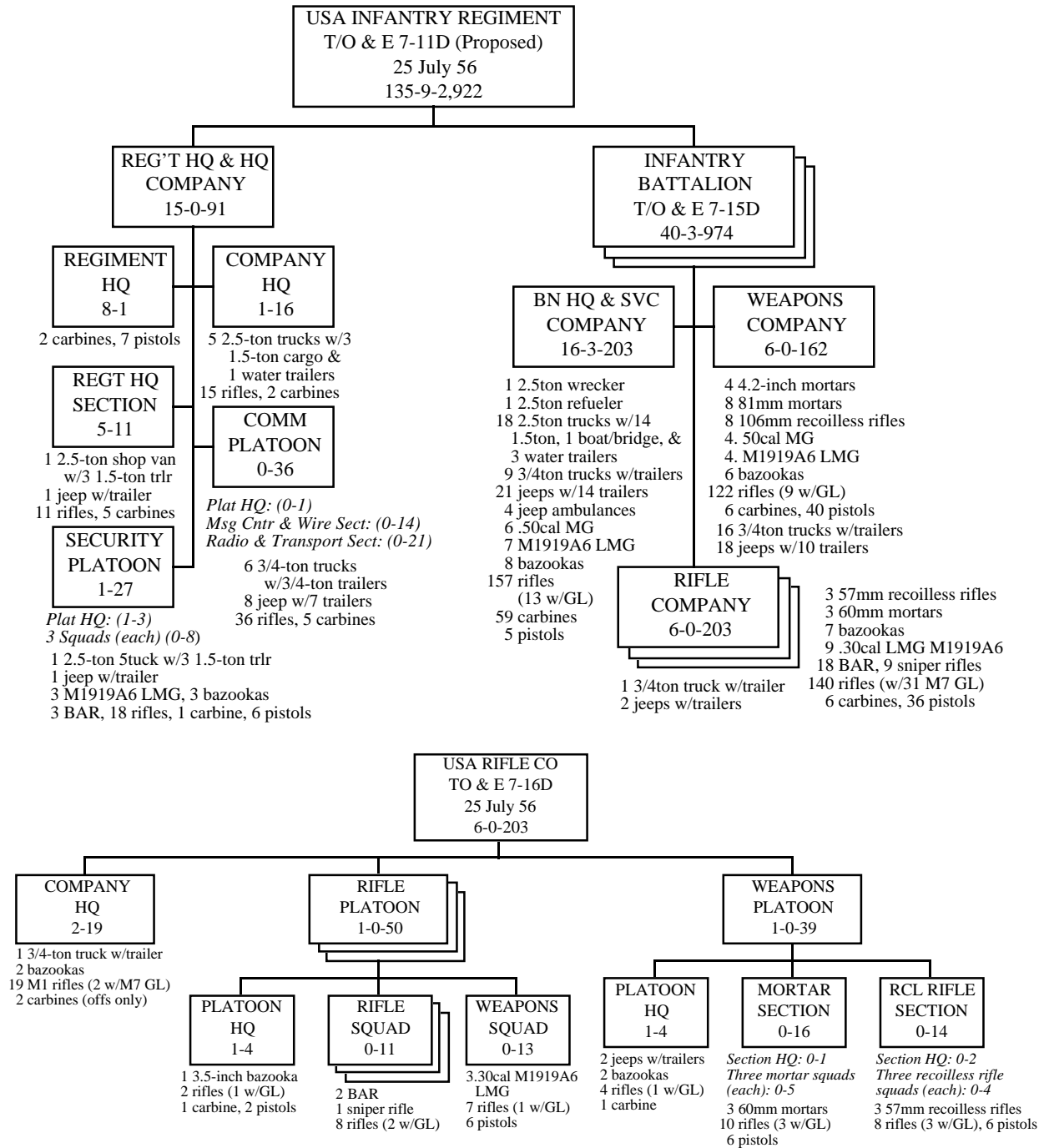



**Appendix 8.7 (continued)**

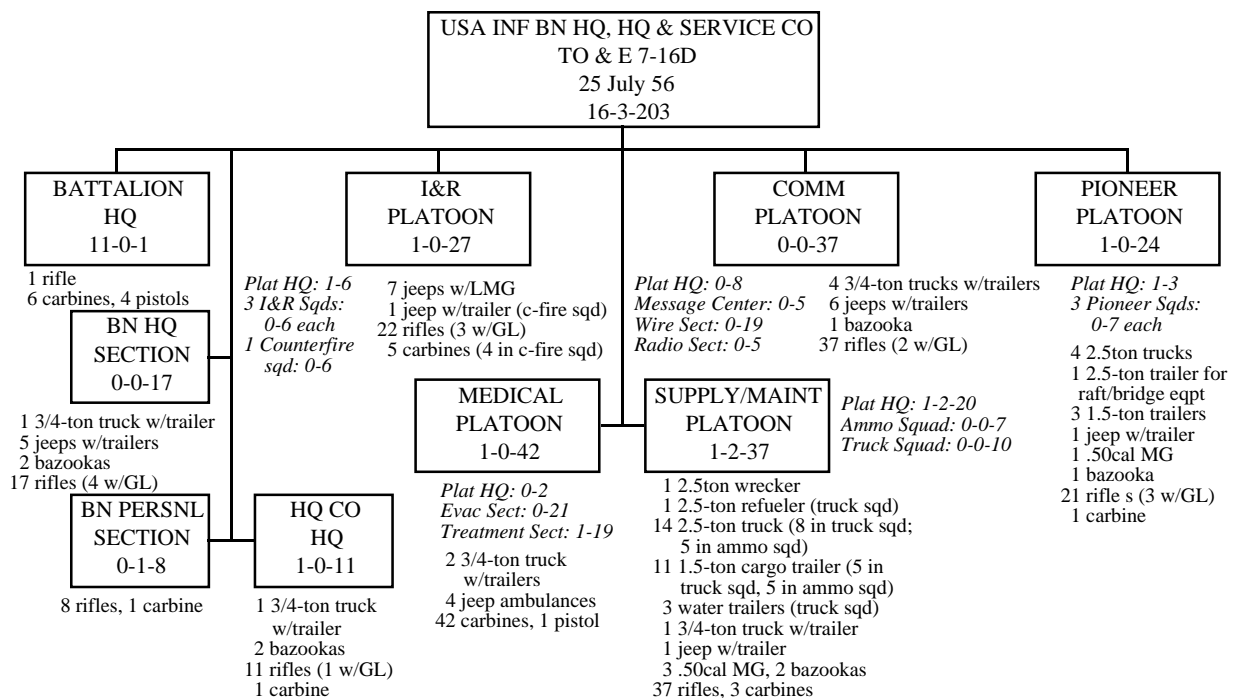
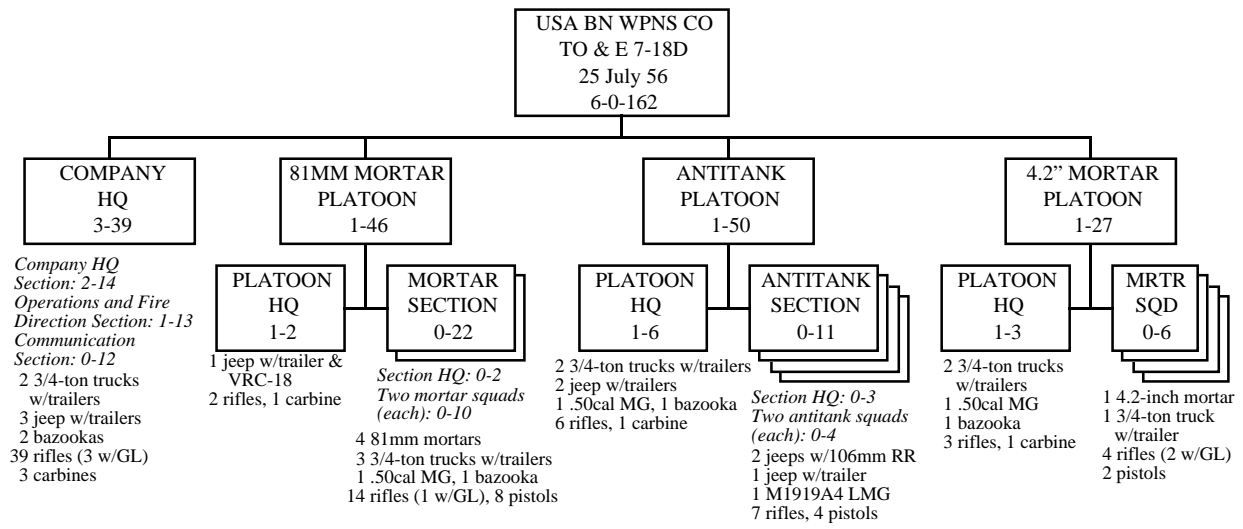

**Notes:**

**Small Arms Distribution:** Only company-grade officers and medical personnel carried carbines. Pistols went to field-grade officers and the gunners (and sometimes assistant gunners) of crew served weapons. All others carried rifles. Weapons and pioneer squad leaders usually had grenade launchers.

**Battalion Headquarters:** This included the battalion commander (lieutenant colonel), executive officer (major); the S-3 and the battalion surgeon (both major); the S1, S2, assistant S3 for air, the S4, motor officer, communication officer and chaplain were all captains. There was also a liaison officer (lieutenant) and the battalion sergeant major.

**Sources:** Headquarters, Continental Army Command Proposed Tables of Organization 7-11D "Infantry Regiment;" 7-12D "Headquarters and Headquarters Company, Infantry Regiment;" 7-15D "Infantry Battalion;" 7-16D "Headquarters, Headquarters and Service Company, Infantry Battalion;" 7-17D "Infantry Rifle Company;" and 7-18D "Infantry Weapons Company" (Fort Monroe, Virginia 25 July 1956).

Appendix 8.8

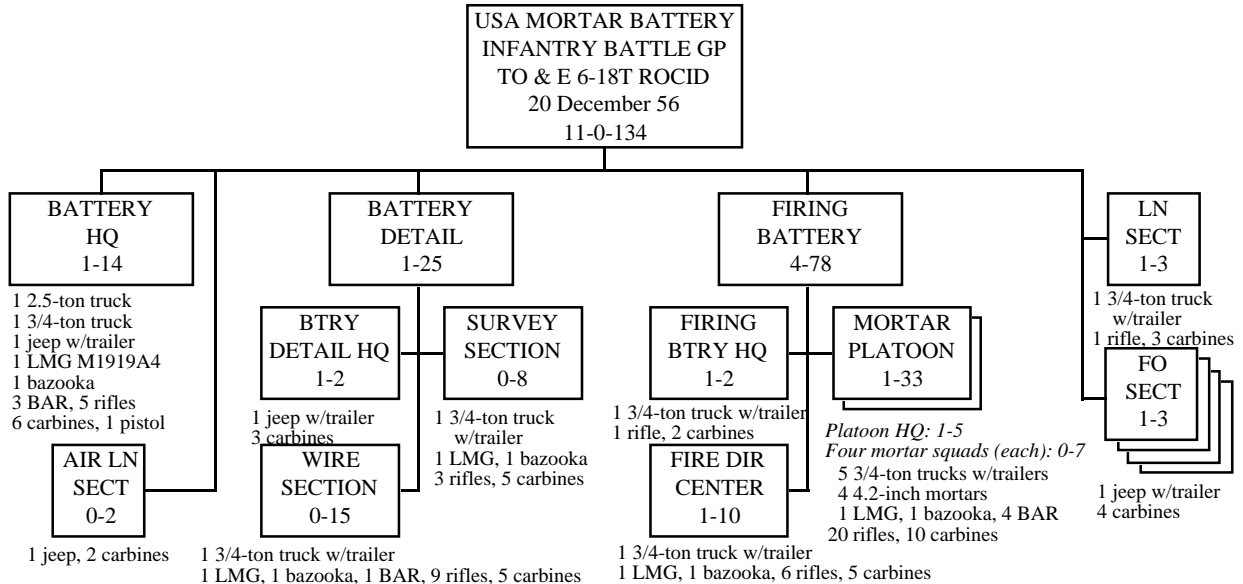
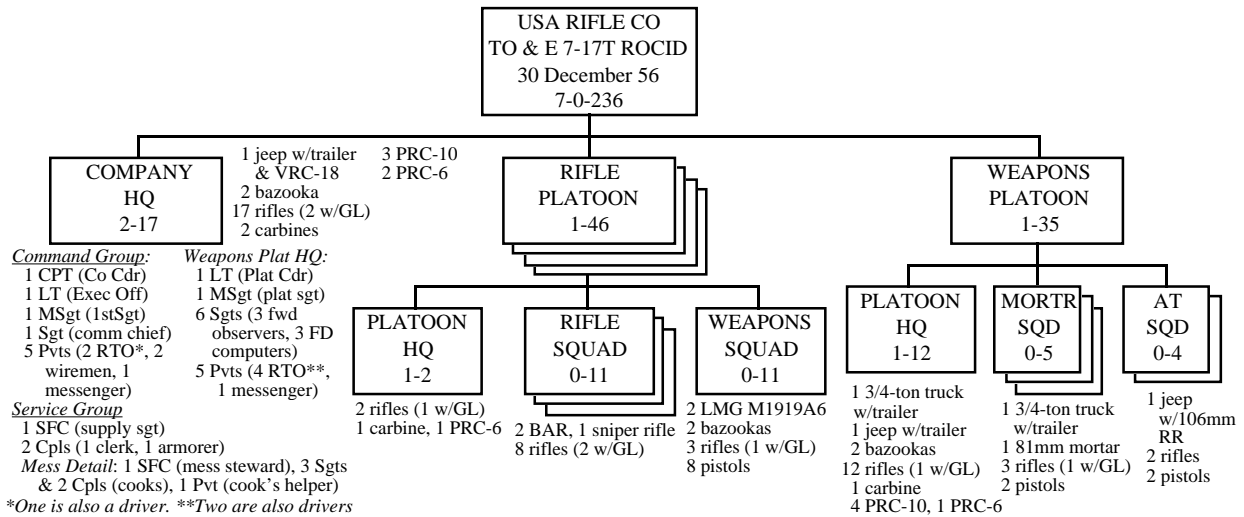
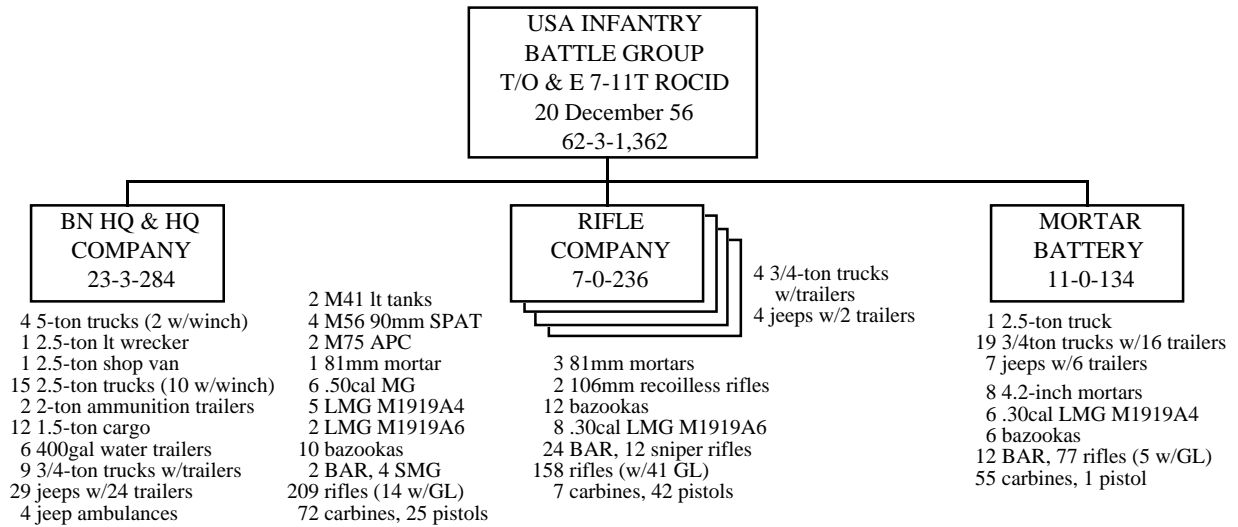

**Appendix 8.8 (continued)**

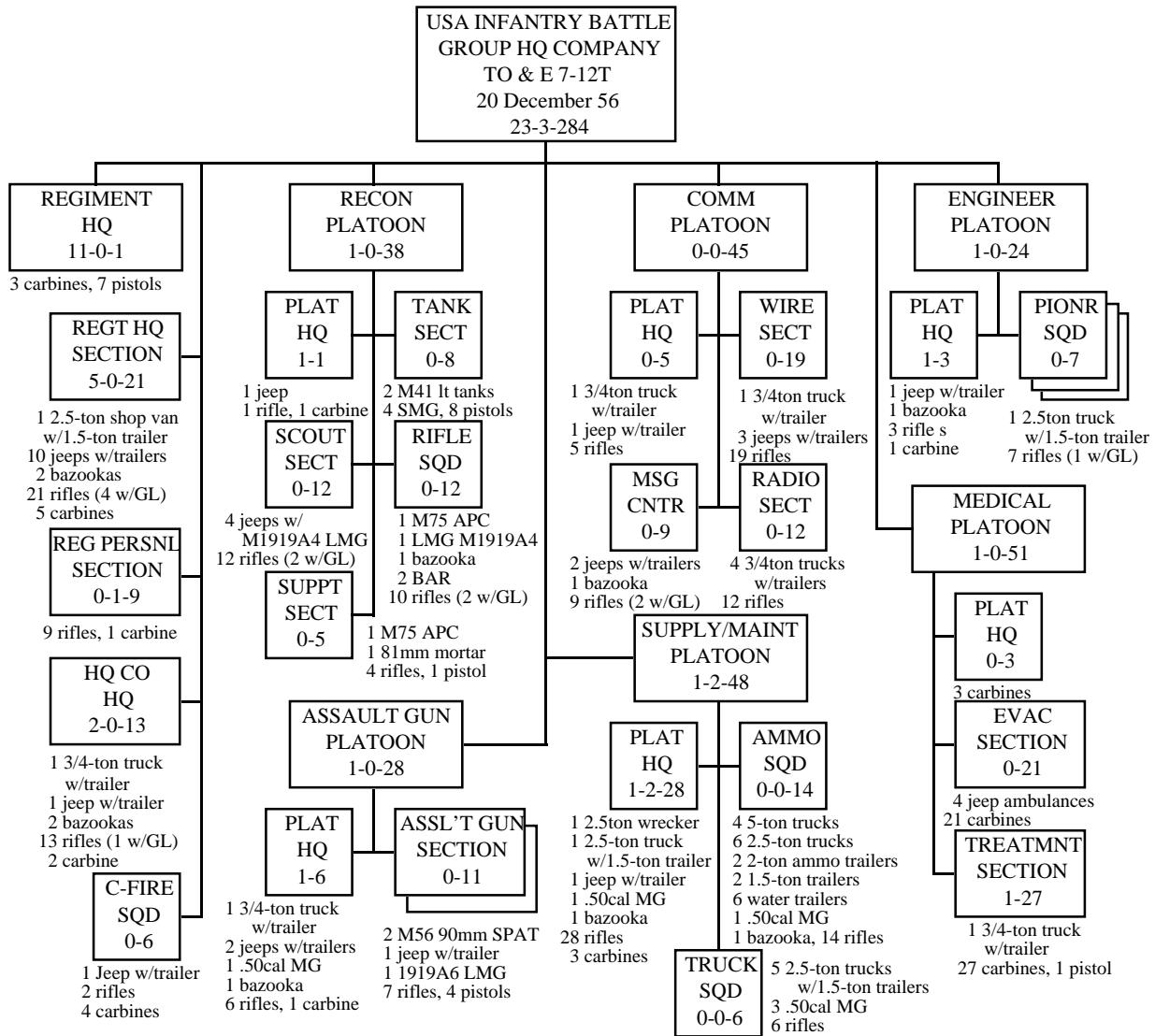

**Notes:**

**Regiment/Group Headquarters and Headquarters Section:** This included a colonel (commander), a lieutenant colonel (executive officer), and the sergeant major. The S1, S2, S3, S4, regimental surgeon, and senior chaplain were majors. The communication officer, motor officer, and junior chaplain were captains. The regimental headquarters section provided an assistant S2, an assistant S3, an assistant S3 for air, and two liaison officers (all captains). Its enlisted members included an intelligence sergeant (MSgt) and an assistant intelligence sergeant (SFC) for the S2; an operations sergeant (MSgt), assistant operations and counter-fire operations sergeants (both SFC) and an information specialist (Cpl) for the S3. There were also two chaplain's assistants (corporals) with jeeps, four clerks (one for mail delivery, all corporals), eight jeep driver/RTO's (all privates) and a driver for the sections 2.5-ton shop van.

**Sources:** Department of the Army Tentative Tables of Organization 7-11T ROCID "Infantry Regiment;" 7-12T ROCID "Headquarters, Headquarters and Service Company, Infantry Regiment;" 7-17T ROCID "Infantry Rifle Company;" and 6-18T ROCID "Mortar Battery" (Washington DC 20 December 1956).

Appendix 8.9

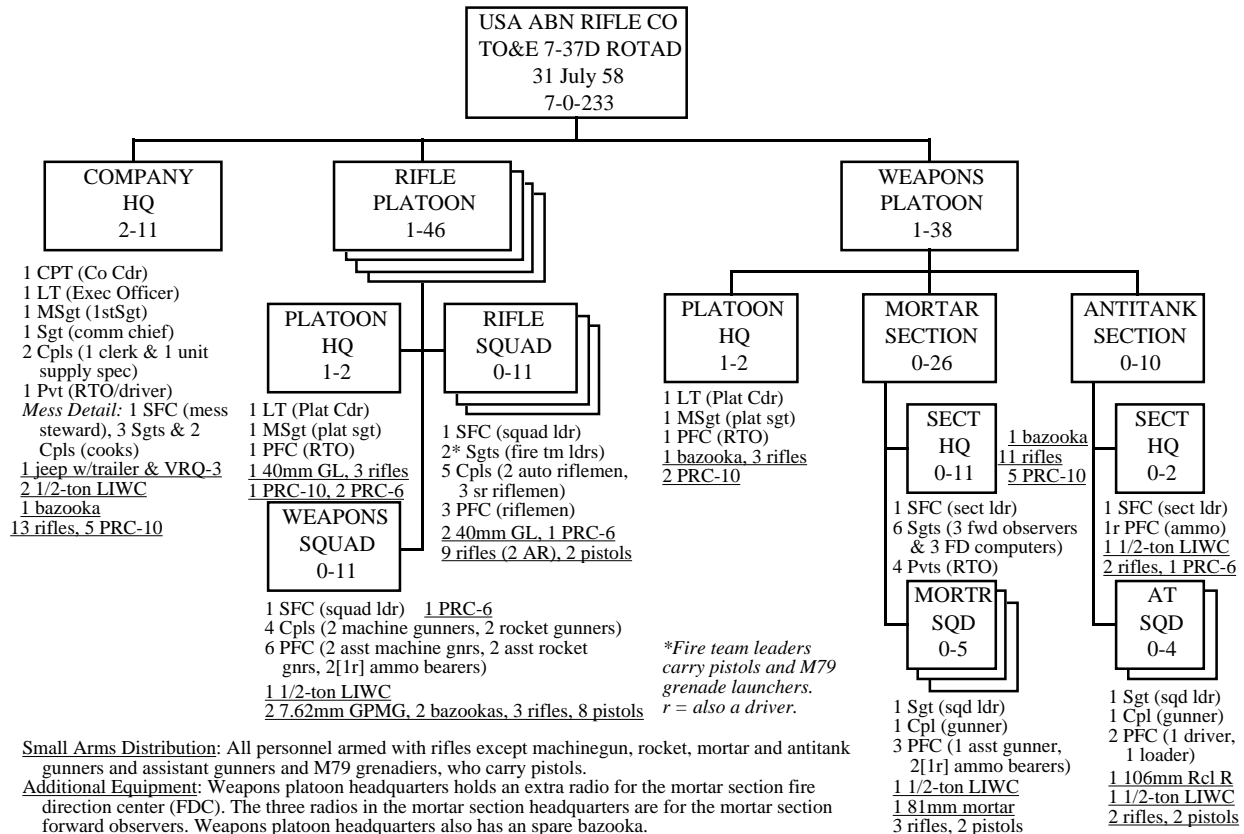
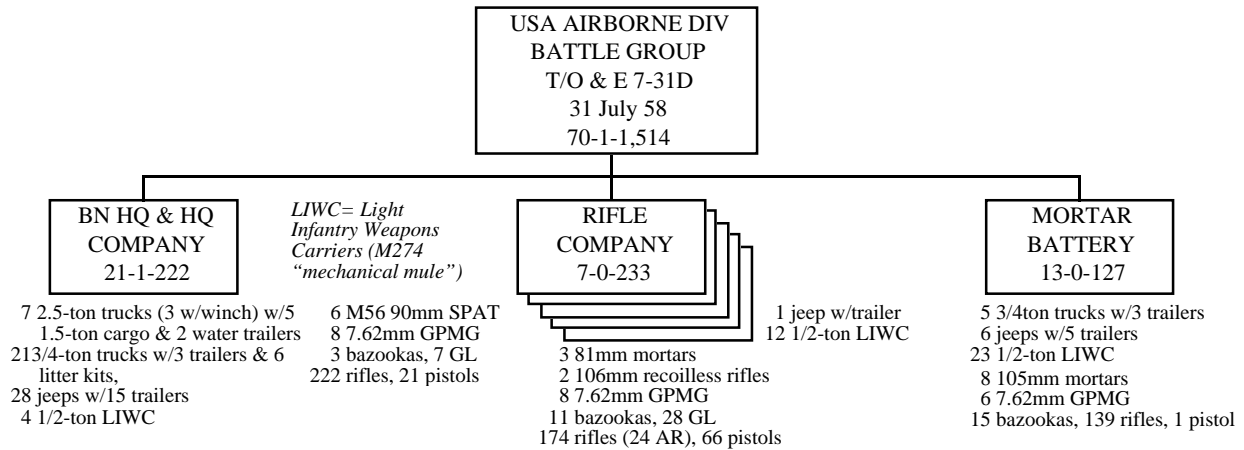

Notes:

Sources: Department of the Army Tables of Organization 7-31D "Airborne Division Battle Group" and 7-37D "Rifle Company, Airborne Division Battle Group" (Washington DC 31 July 1958).

Appendix 8.10

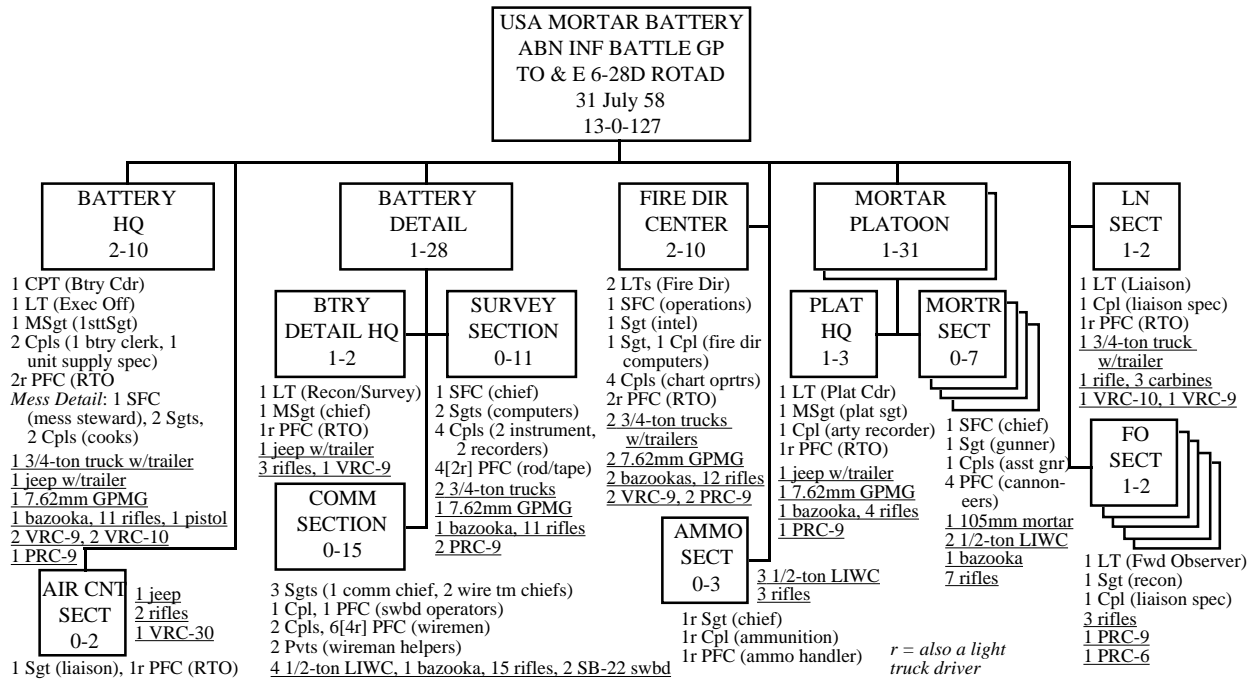

Notes:

Source: Department of the Army Table of Organization 6-28D "Mortar Battery, Airborne Division Battle Group" (Washington DC 31 July 1958).

Appendix 8.11

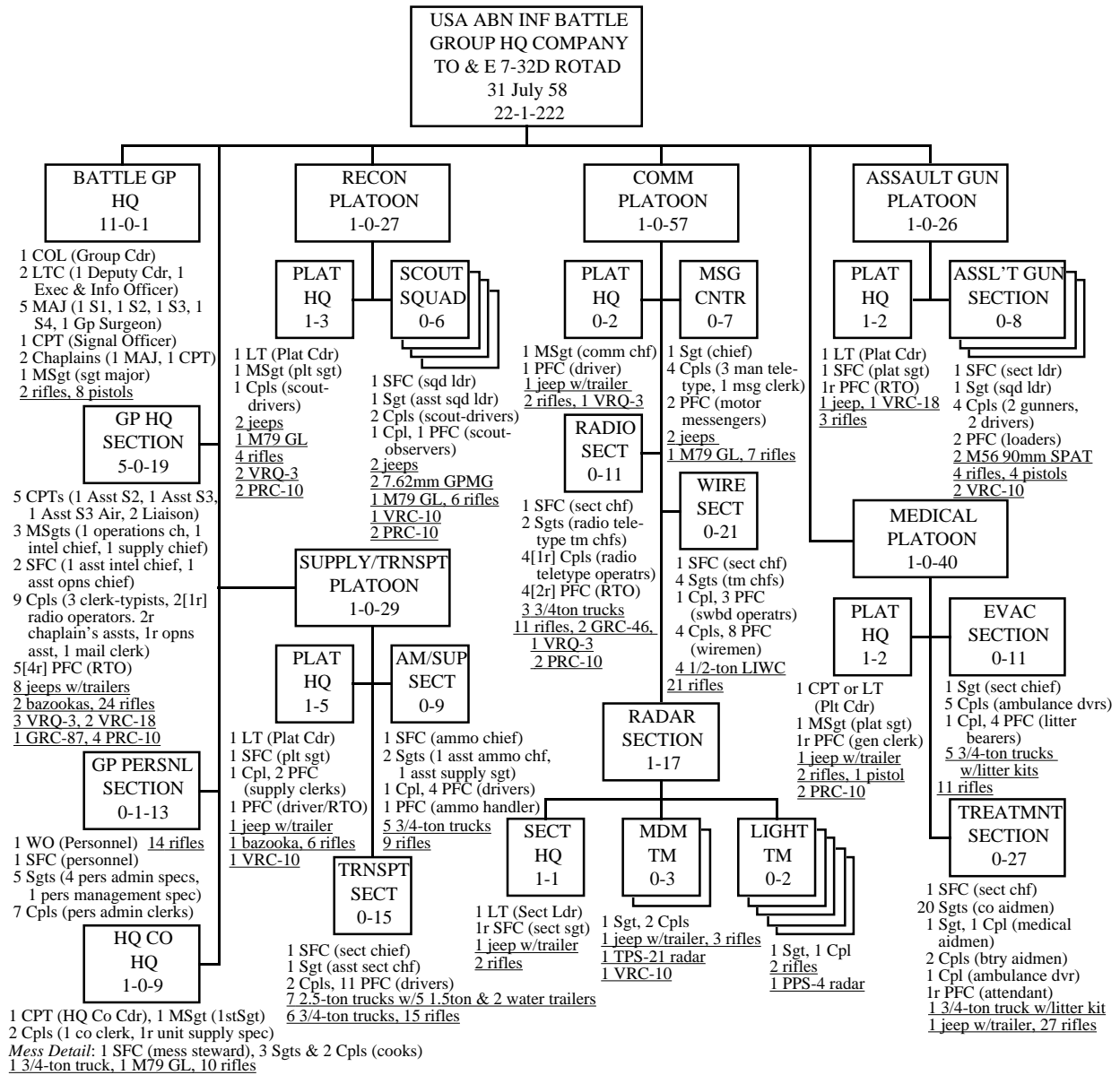

Notes:

Source: Department of the Army Table of Organization 7-32D "Headquarters and Headquarters Company, Airborne Division Battle Group" (Washington DC 31 July 1958).

Appendix 8.12

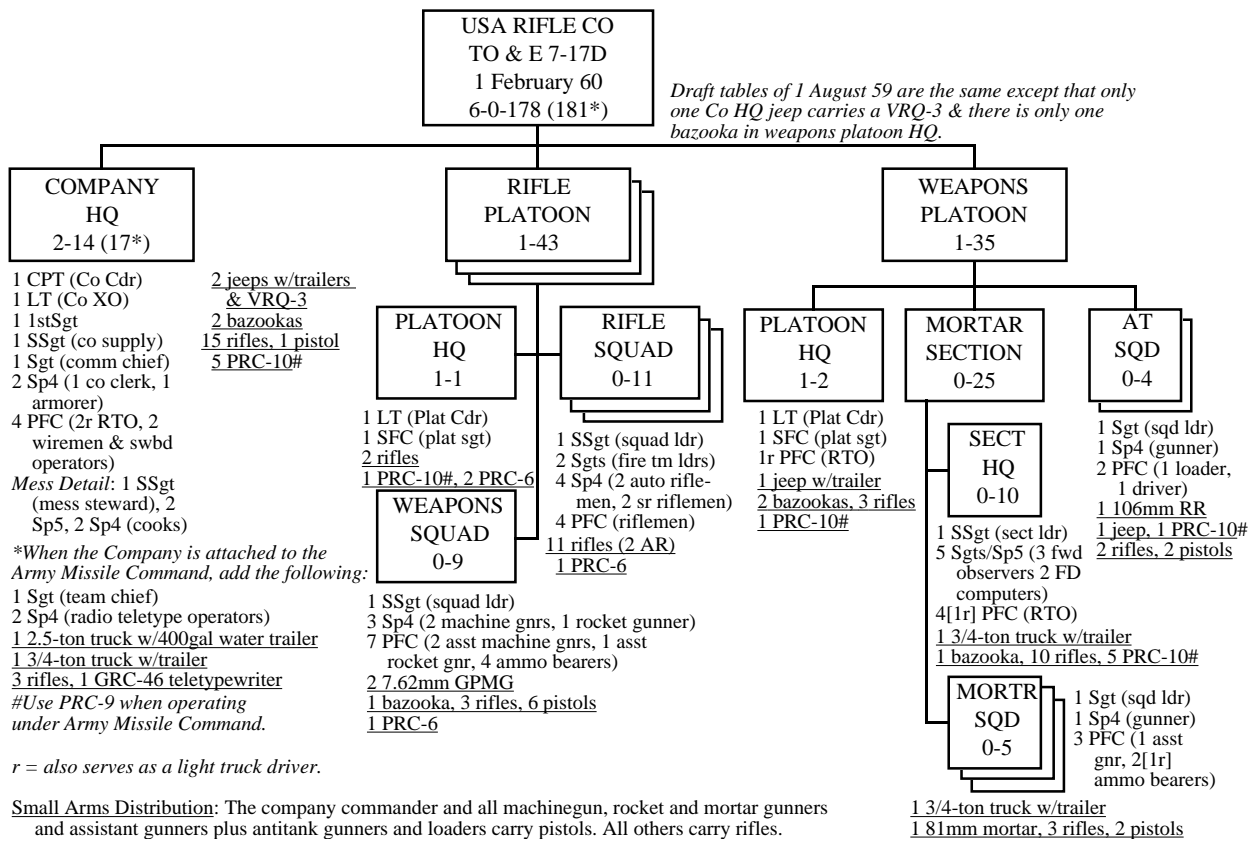
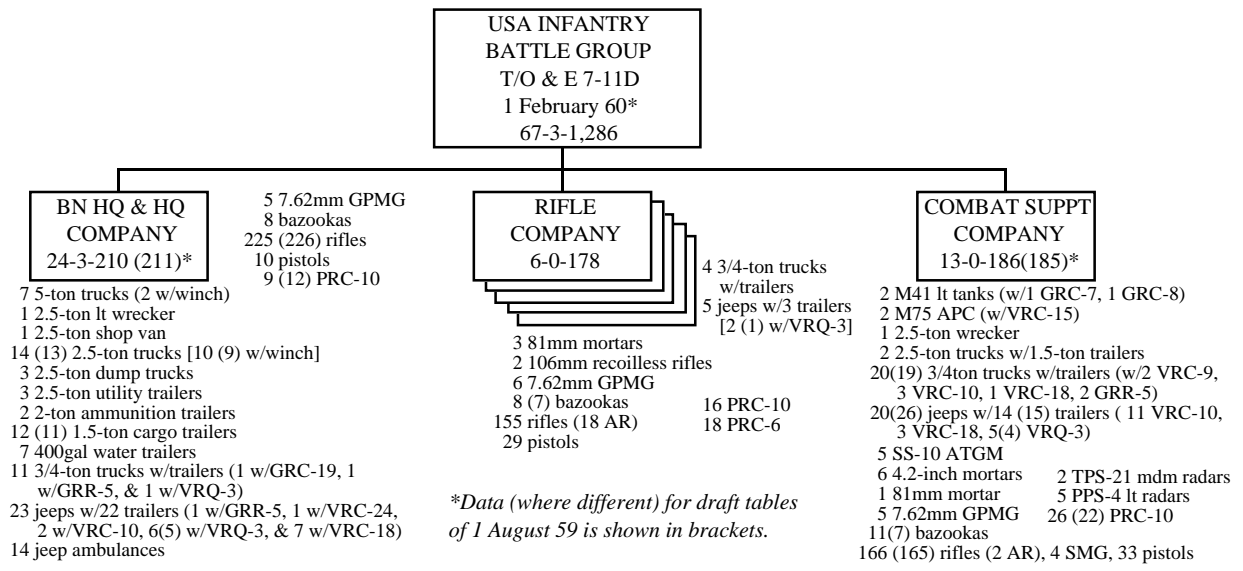

Notes:

**Enlisted Ranks:** The 1958 enlisted rank system is in use in these diagrams. Soldiers in pay grade E-5 are shown as specialist 5 (Sp5) rather than sergeant when not occupying a leadership position (as would typically be the case in an actual unit). All E-4 soldiers appear as specialist 4 (Sp4) rather than corporal.

**Sources:** Department of the Army Tables of Organization 7-11D "Infantry Division Battle Group" and 7-17D "Rifle Company, Infantry Division Battle Group" (Washington DC 1 August 1959 and 1 February 1960).

Appendix 8.13

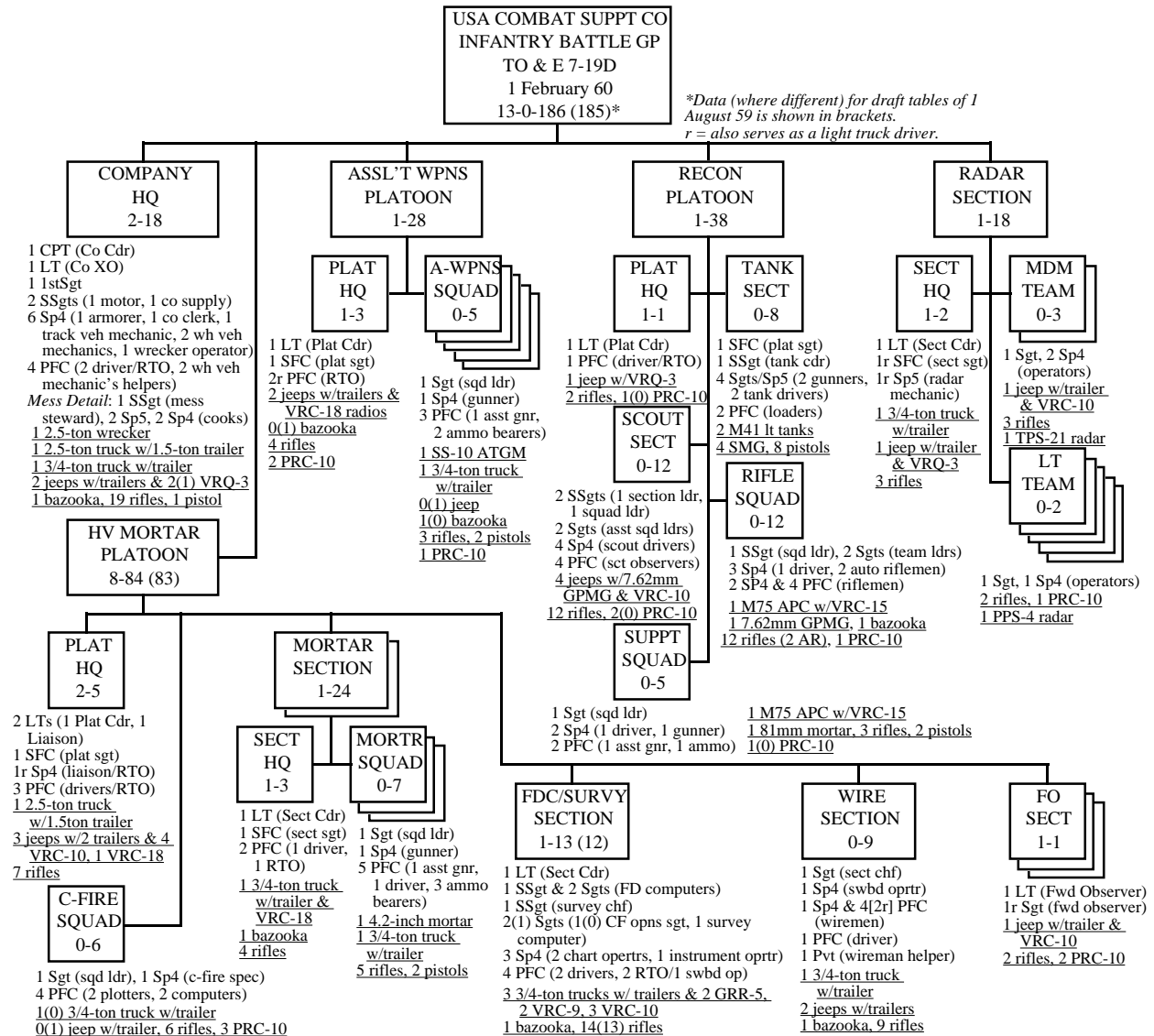

Notes:

**Enlisted Ranks:** The 1958 enlisted rank system is in use in these diagrams. Soldiers in pay grade E-5 are shown as specialist 5 (Sp5) rather than sergeant when not occupying a leadership position (as would typically be the case in an actual unit). All E-4 soldiers appear as specialist 4 (Sp4) rather than corporal.

**Source:** Department of the Army Table of Organization 7-19D "Combat Support Company, Infantry Division Battle Group" (Washington DC 1 August 1959 and 1 February 1960).



## Appendix 8.14

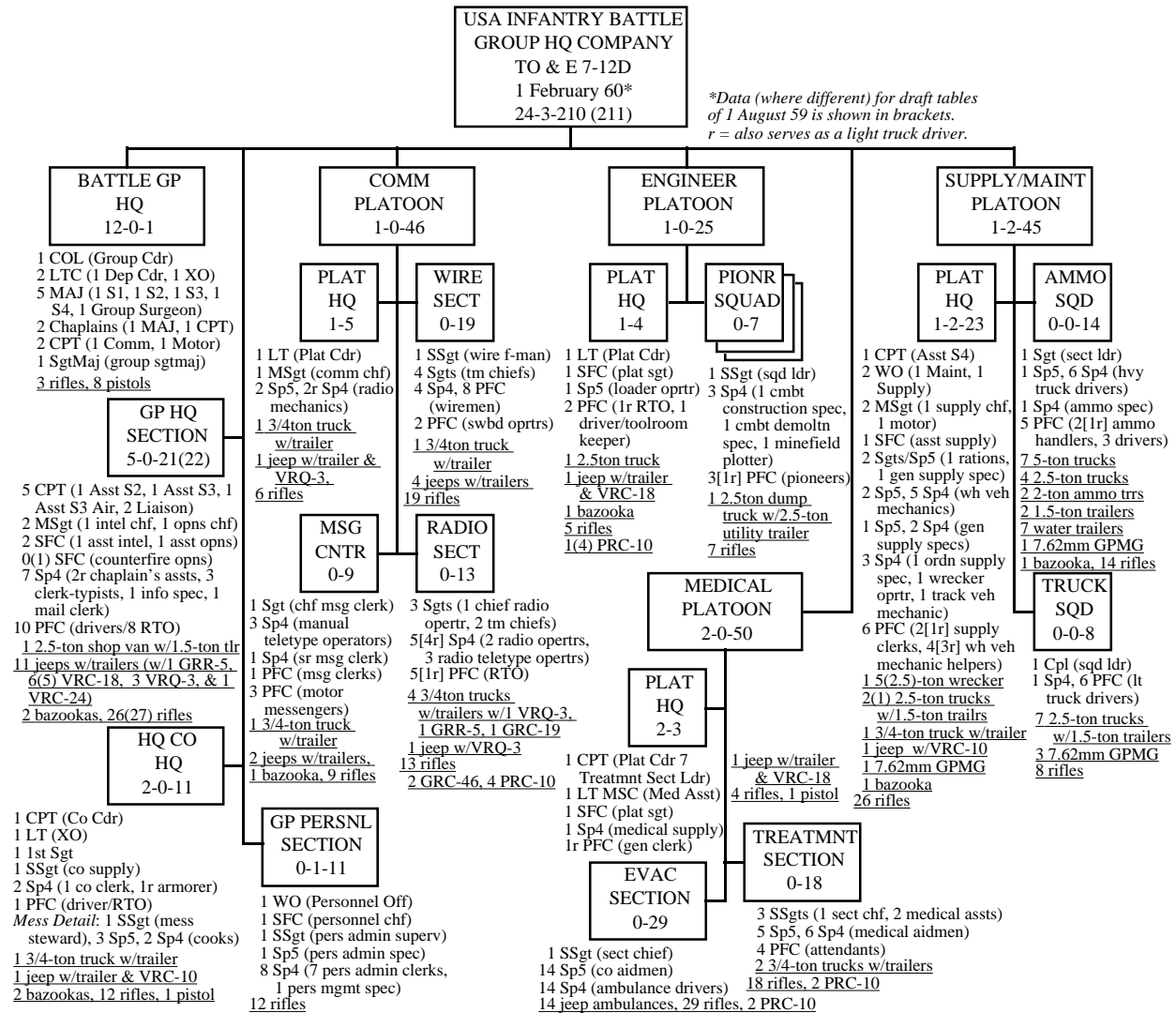

**Notes:**

**Enlisted Ranks:** The 1958 enlisted rank system is in use in these diagrams. Soldiers in pay grade E-5 are shown as specialist 5 (Sp5) rather than sergeant when not occupying a leadership position (as would typically be the case in an actual unit). All E-4 soldiers appear as specialist 4 (Sp4) rather than corporal.

**Source:** Department of the Army Table of Organization 7-12D "Headquarters and Headquarters Company, Infantry Division Battle Group" (Washington DC 1 August 1959 and 1 February 1960).

## Appendix 8.15

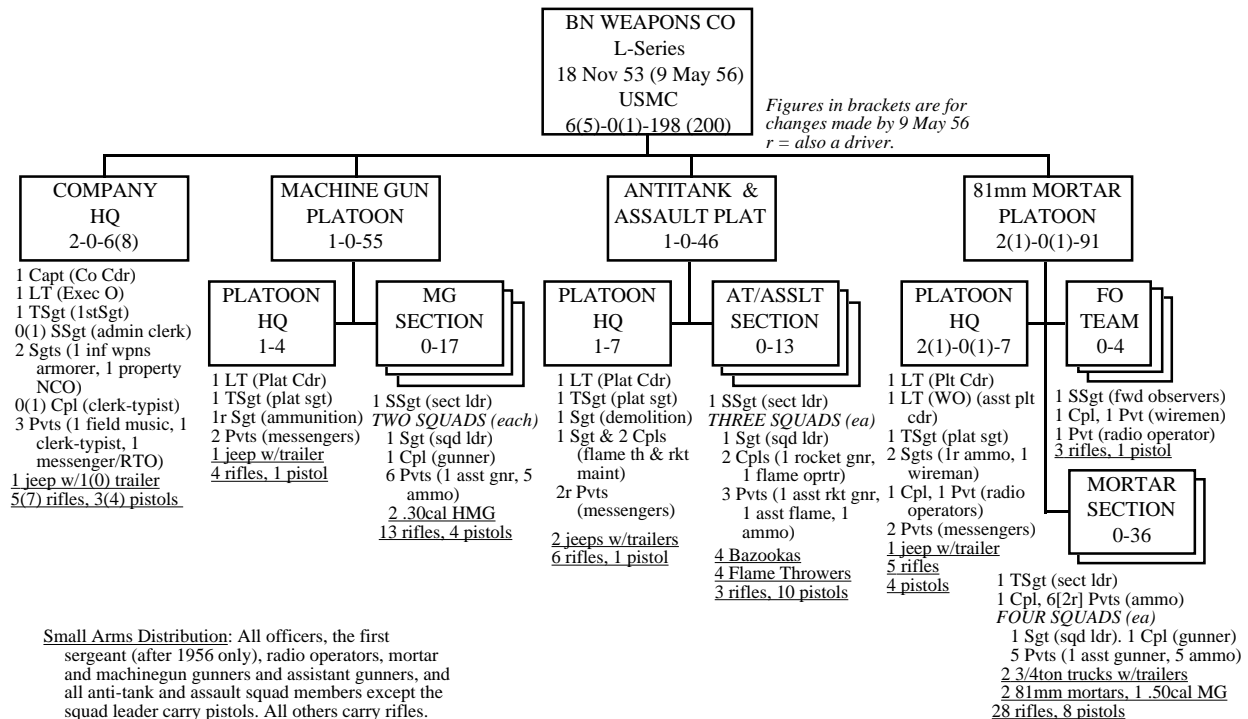
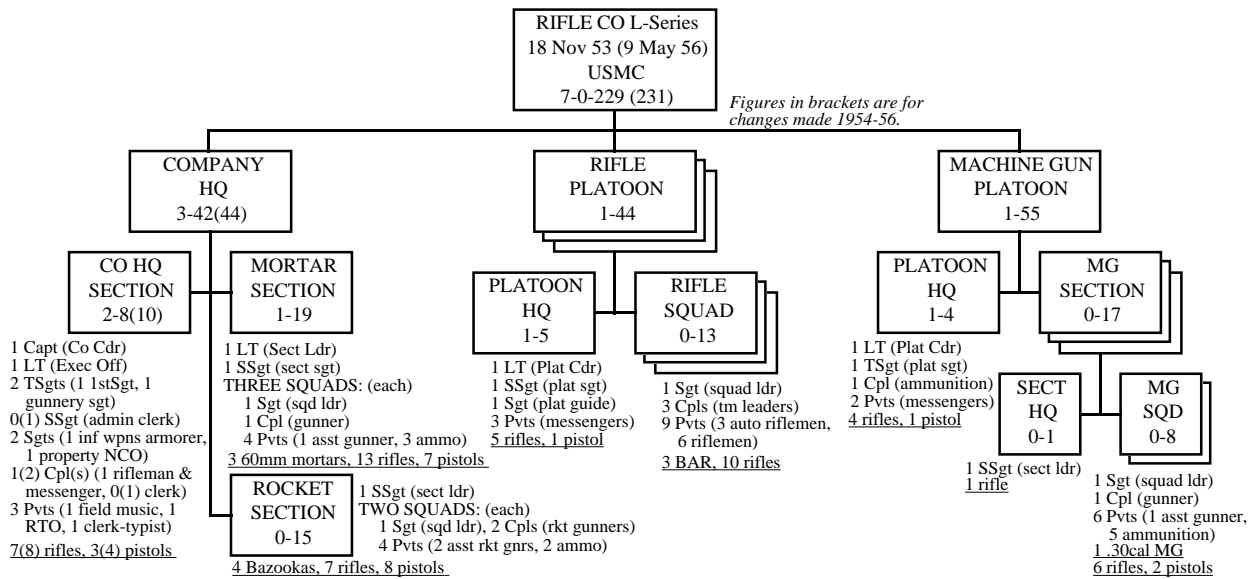

**Notes:**

**Communication Equipment:** This included one AN/PRC-10 man-pack radio eight AN/PRC-6 radios for the rifle company and five AN/PRC-10 and four AN/PRC-6 for the weapons company. The rifle company would have kept its PRC-10 at the company command post to guard the battalion command net. It would have given a PRC-6 to each rifle platoon headquarters and the machinegun platoon headquarters. At least one each would have been at the company CP and the mortar section. The other two could have to the company (as a spare) to one or two mortar observers and/or the rocket section. The weapons company would have kept two PRC-10's at its CP (one for the company command net and the other for the battalion command net) and issued a PRC-10 each to its three platoon headquarters. The PRC-6's would have gone to the three mortar platoon forward observers and to the platoon fire direction center.

**Sources:** Marine Corps Tables of Organization L-1013 "Rifle Company, Infantry Battalion, Infantry Regiment, Marine Division, Fleet Marine Force" and L-1023 "Weapons Company, Infantry Battalion, Infantry Regiment, Marine Division, Fleet Marine Force" (Washington DC dated 18 November 1953 and 9 May 1956, with Tables of Equipment dated 3 May 1954 and 1 August 1957).

## Appendix 8.16

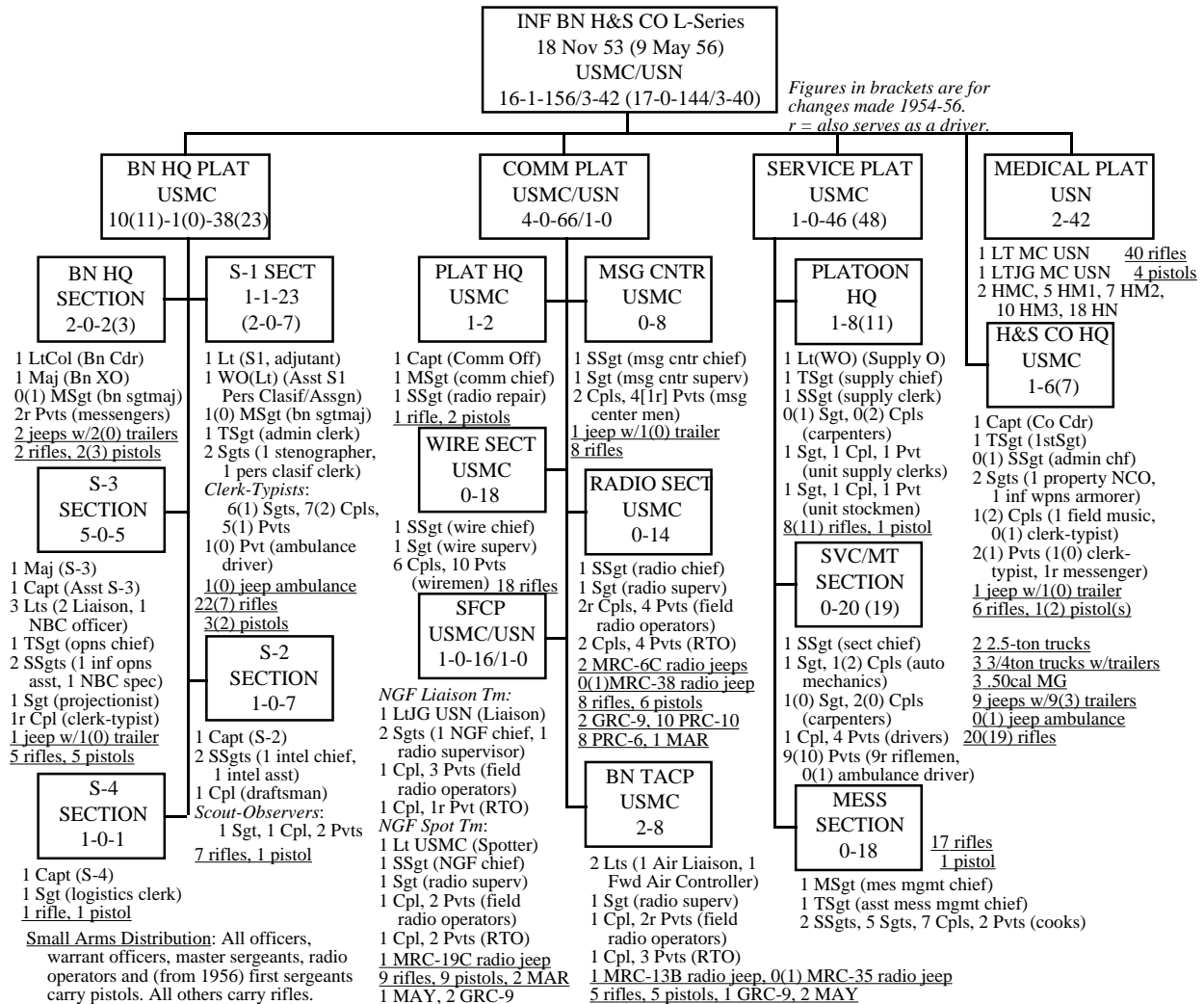

**Notes:**

Note that the two 2.5-ton trucks with the service and motor transport section of the battalion service platoon usually towed water trailers that belonged to the regimental headquarters and service company.

**Communication Equipment:** The table of equipment, although it gives the total amount of radio equipment that the H&S company was authorized, does not indicate how it was distributed between the radio section, shore fire control party and tactical air control party. The AN/MRC-13 is shown with the TACP because it was designed to operate with the MAY, which was the primary air-to-ground radio. The AN/MRC-35 was also an air-ground communication system. The MAR was suitable for both air-ground and ship to shore communication. K-series equipment tables show that the radio section had been using the AN/MRC-6 since 1949 and that the SFCP had been using the AN/MRC-19 since at least 1951. The MRC-6 used the same Navy-type radio used by boats, amphibious vehicles and warships. The GRC-9 replaced the GRC-13 in the SFCP and TACP after Korea (see Maj. Charles W. Blyth "The Weak Link" Marine Corps *Gazette* March 1959 pp 36-37). The radio section would almost certainly issue one or more PRC-10 and PRC-6 radios to the SFCP and TACP so they could maintain communication with the rifle companies.

**Source:** Marine Corps Table of Organization L-1037 "Headquarters and Service Company, Infantry Battalion, Infantry Regiment, Marine Division, Fleet Marine Force" (Washington DC dated 18 November 1953 and 9 May 1956, with Tables of Equipment dated 3 May 1954 and 1 August 1957).

**Appendix 8.17**

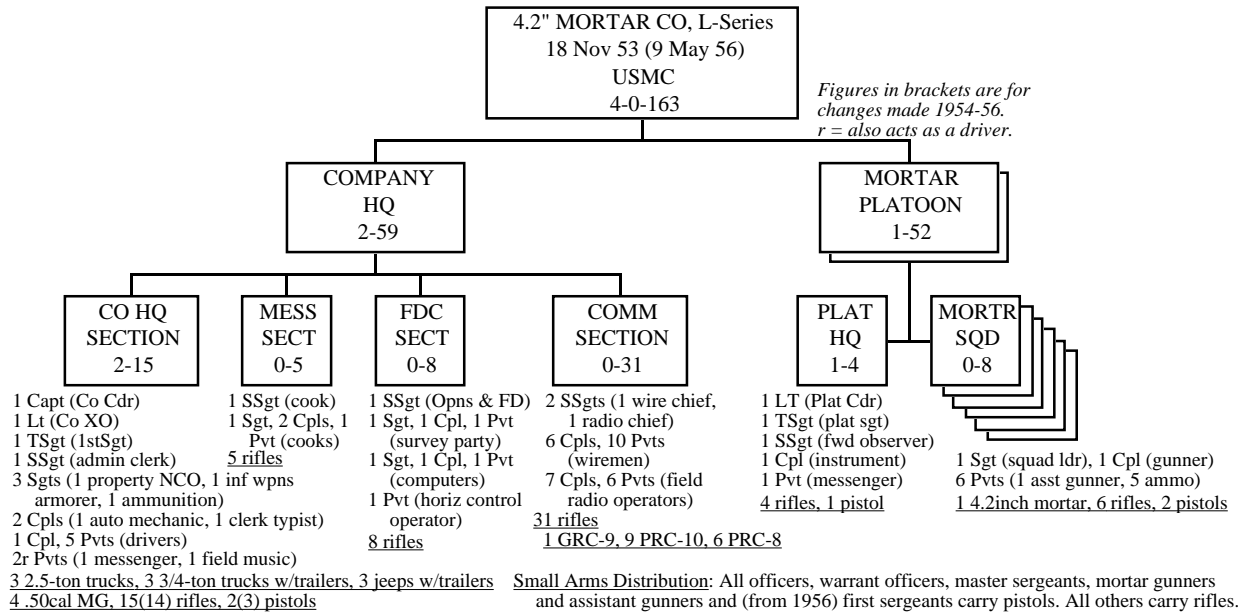

Notes

Note that the three 2.5-ton trucks with company headquarters section usually towed water trailers that belonged to the regimental headquarters and service company.

Source: Marine Corps Table of Organization L-1083 "4.2-inch Mortar Company, Infantry Regiment, Marine Division, Fleet Marine Force" (Washington DC dated 18 November 1953 and 9 May 1956, with Tables of Equipment dated 3 May 1954 and 1 August 1957).

### Appendix 8.18

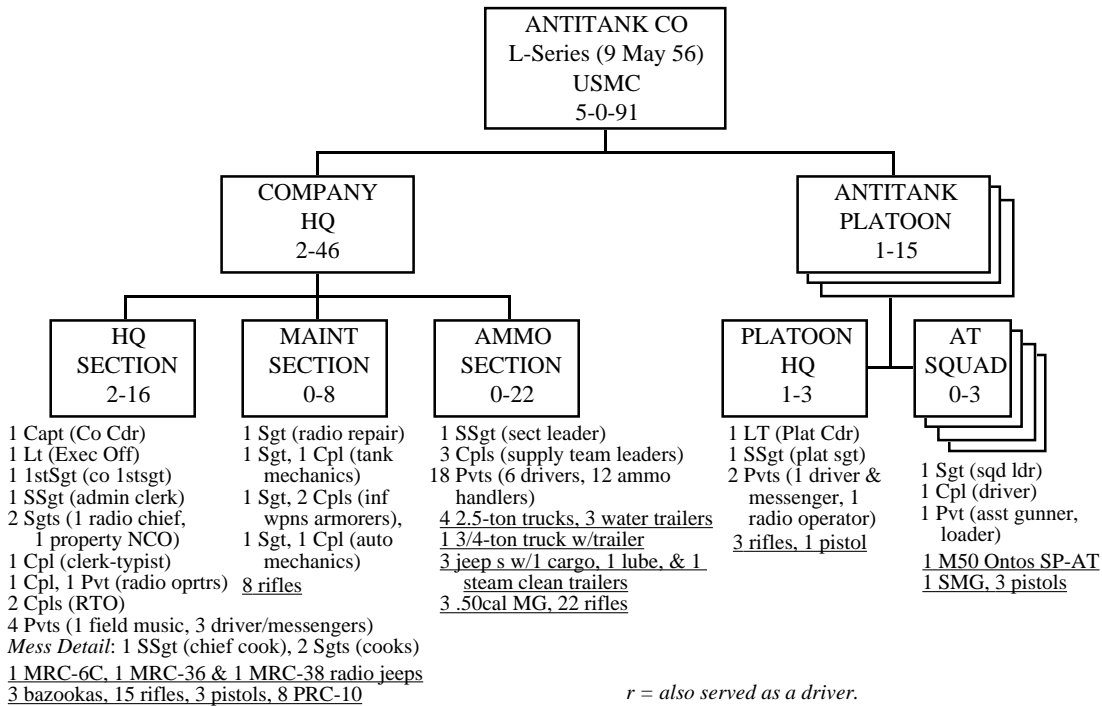
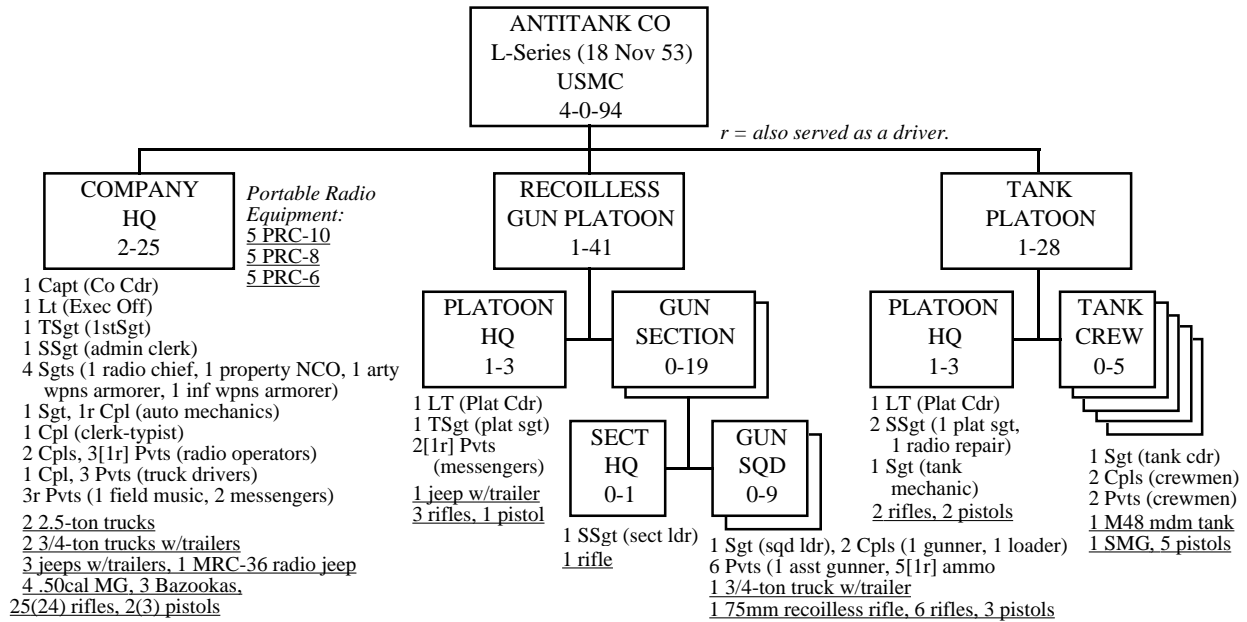

**Notes:**

Note that the two 2.5-ton trucks with the headquarters of the 1953-54 company usually towed water trailers that belonged to the regimental headquarters and service company.

**Communication equipment:** The AN/PRC-8 man-pack radio was the armored unit version of the AN/PRC-10. Like the AN/PRC-9 it was the same radio but it operated over a different frequency band. The AN/MRC-36 was a 215-pound tactical radio set mounted in a jeep with a main transmitter-receiver with a 10-mile range and an auxiliary transmitter-receiver with a one-mile range. It had full duplex operation and could do automatic retransmissions. The AN/MRC-36 was for armored units. The AN/MRC-37 was the same system but transmitting in a frequency band for artillery units while the AN/MRC-38 did the same for infantry units.

**Sources:** Marine Corps Table of Organization L-1073 "Antitank Company, Infantry Regiment, Marine Division, Fleet Marine Force" (Washington DC dated 18 November 1953 and 9 May 1956, with Tables of Equipment dated 3 May 1954 and 1 August 1957).

Appendix 8.19

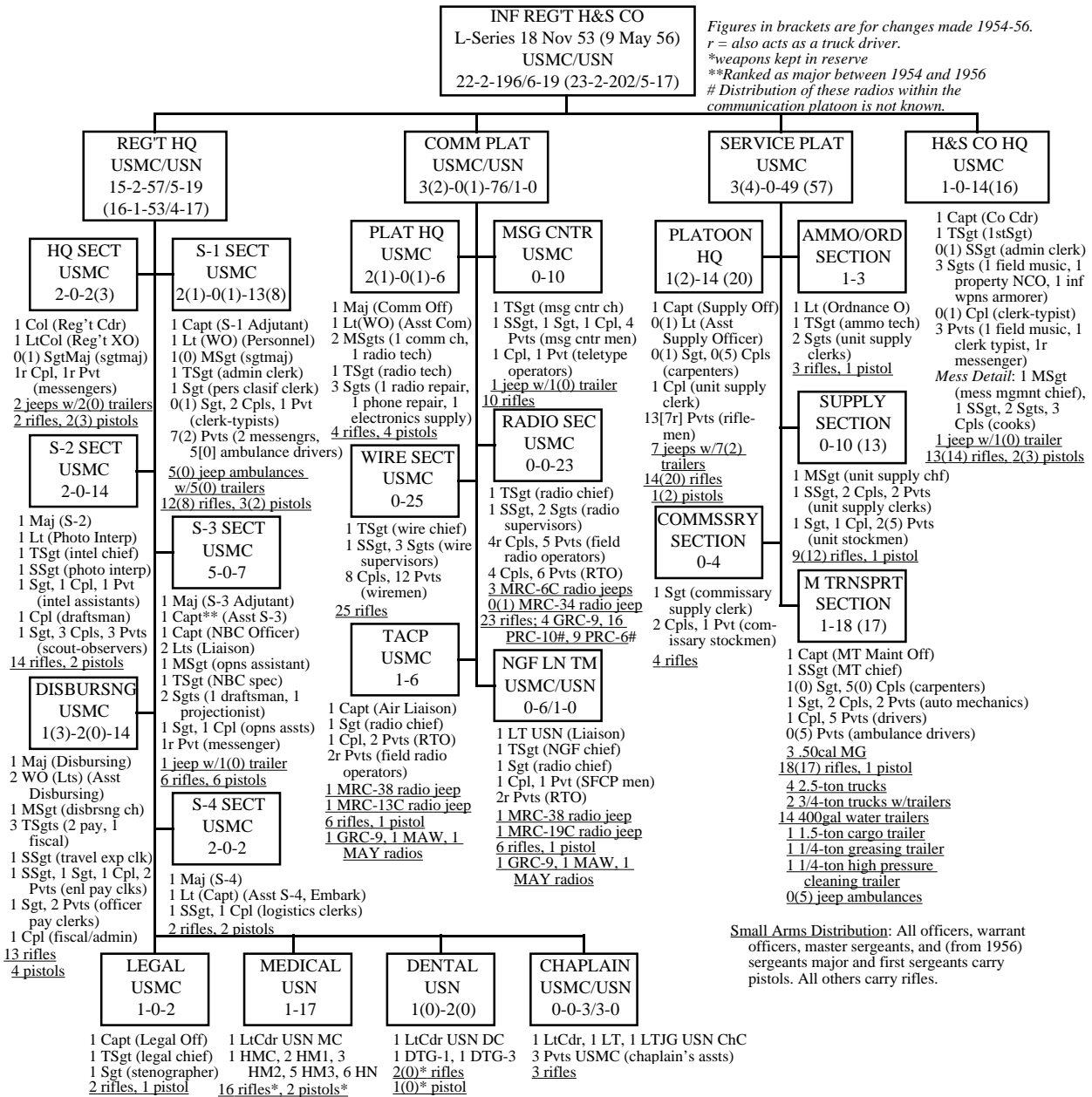

Notes:

**Motor Transport Equipment:** Note that the 2.5-ton trucks held by the antitank, mortar and battalion headquarters and service companies as well as those belonging to the motor transport section towed the water and cargo trailers belonging to the motor transport section of the battalion service platoon.

**Communication Equipment:** See the remarks for Appendices 8.16 and 8.18.

**Source:** Marine Corps Table of Organization L-1097 "Headquarters and Service Company, Infantry Regiment, Marine Division, Fleet Marine Force" (Washington DC dated 18 November 1953 and 9 May 1956, with Tables of Equipment dated 3 May 1954 and 1 August 1957).

**Appendix 8.20**

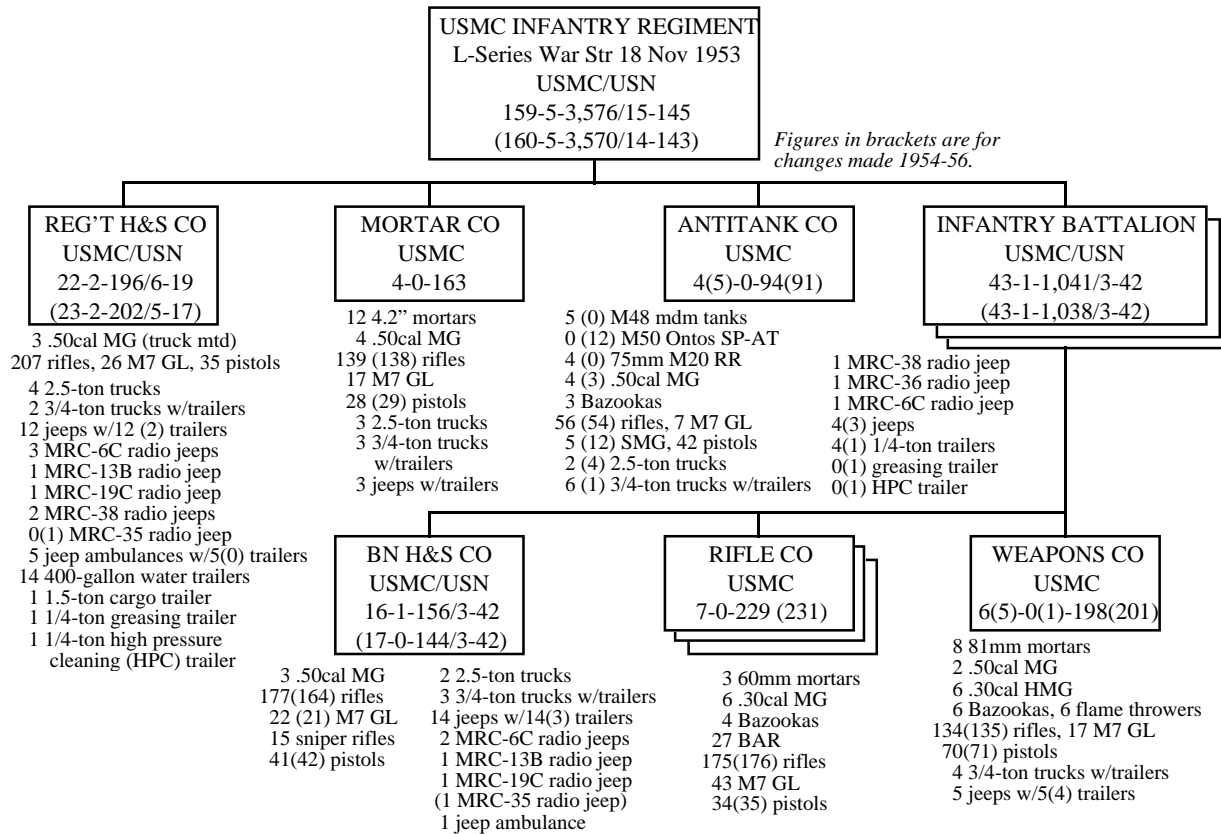

**Notes:**

**Sources:** Marine Corps Tables of Organization L-1038 "Infantry Battalion, Infantry Regiment, Marine Division, Fleet Marine Force" and L-1099 "Infantry Regiment, Marine Division, Fleet Marine Force" (Washington DC dated 18 November 1953 and 9 May 1956, with Tables of Equipment dated 3 May 1954 and 1 August 1957).

**Appendix 8.21**

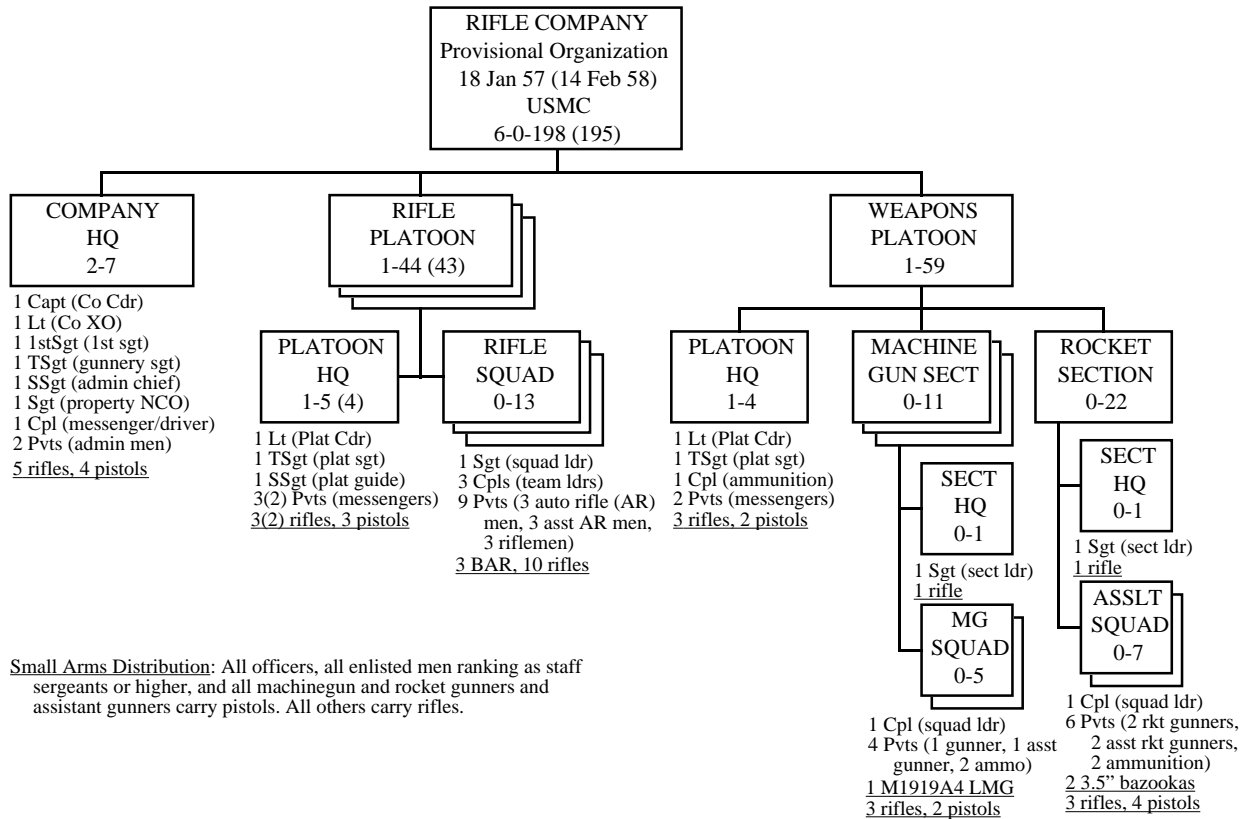

Notes:

**Communication Equipment:** All radio equipment used by the company came from the battalion communication platoon. Normally this consisted of one AN/PRC-10 (for the battalion command net) and six (or more) AN/PRC-6 (one per rifle platoon, one for the weapons platoon, one for the company command post and one spare (for the company commander). The only organic communication equipment in the company was eight CE-11 reel equipments with phones attached.

**Source:** Marine Corps Provisional Table of Organization Prov-1013 "Rifle Company, Infantry Battalion, Infantry Regiment, Marine Division, FMF" (Washington DC dated 18 January 1957 and 14 February 1958, with Table of Equipment dated 14 February 1958).



Appendix 8.22

INF BN H&S CO  
Provisional Organization  
18 Jan 57 (14 Feb 58)  
USMC/USN  
20-1-299 (303)/3-53

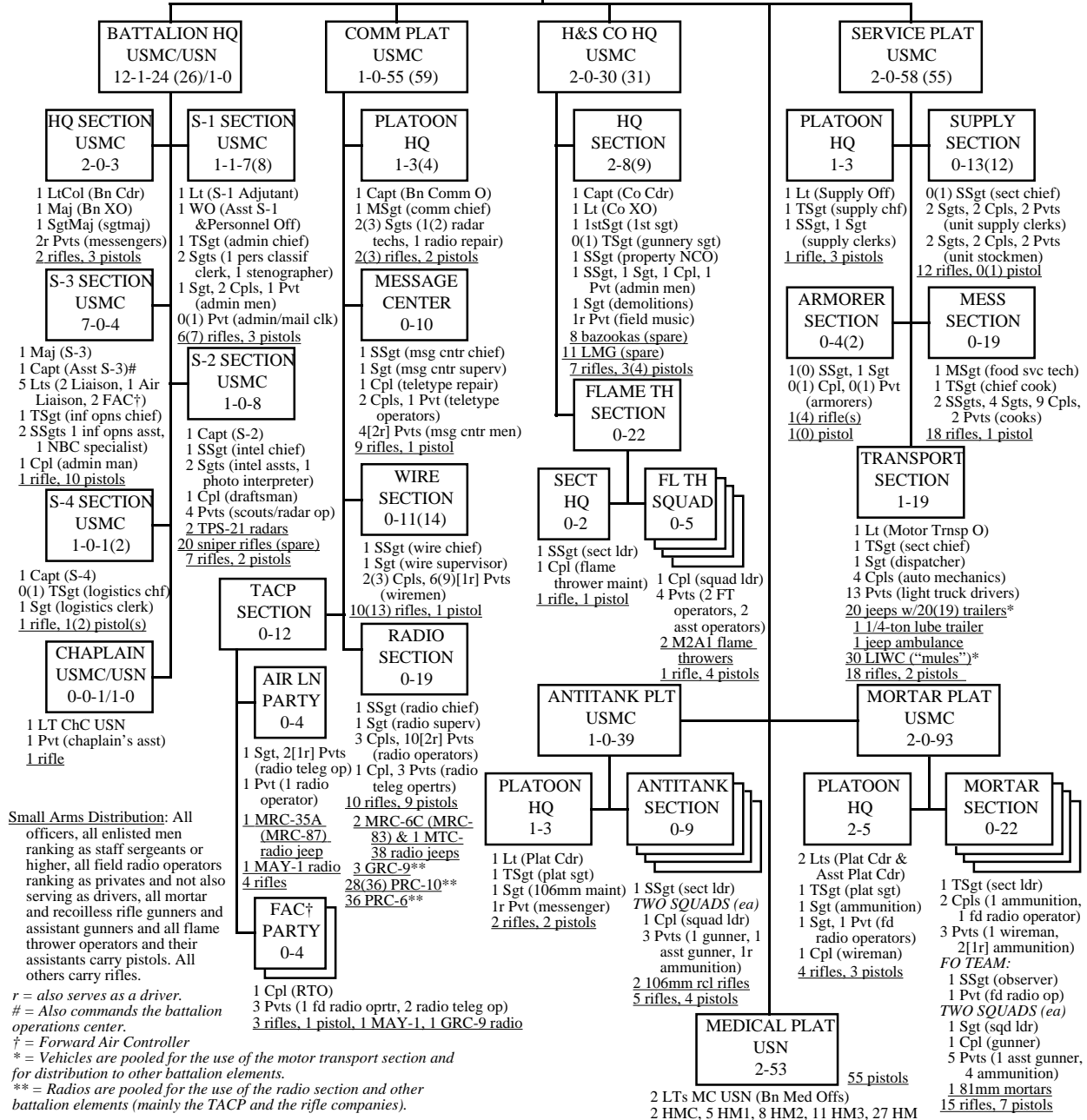

**Small Arms Distribution:** All officers, all enlisted men ranking as staff sergeants or higher, all field radio operators ranking as privates and not also serving as drivers, all mortar and recoilless rifle gunners and assistant gunners and all flame thrower operators and their assistants carry pistols. All others carry rifles.

*r* = also serves as a driver.  
# = Also commands the battalion operations center.  
† = Forward Air Controller  
\* = Vehicles are pooled for the use of the motor transport section and for distribution to other battalion elements.  
\*\* = Radios are pooled for the use of the radio section and other battalion elements (mainly the TACP and the rifle companies).

Notes:

**Communication Equipment:** Radios are listed in the diagram but see also the remarks under Appendix 8.17. Telephone (wire) equipment includes five SB-22 switchboards, 25 CE-11 reel equipments (with phones) and 35 EE-8 telephones. The message center included two AN/TGC-6 teletypewriters.

**Source:** Marine Corps Provisional Table of Organization Prov-1037 "Headquarters and Service Company, Infantry Battalion, Infantry Regiment, Marine Division, FMF" (Washington DC dated 18 January 1957 and 14 February 1958, with Table of Equipment dated 14 February 1958).

Appendix 8.23

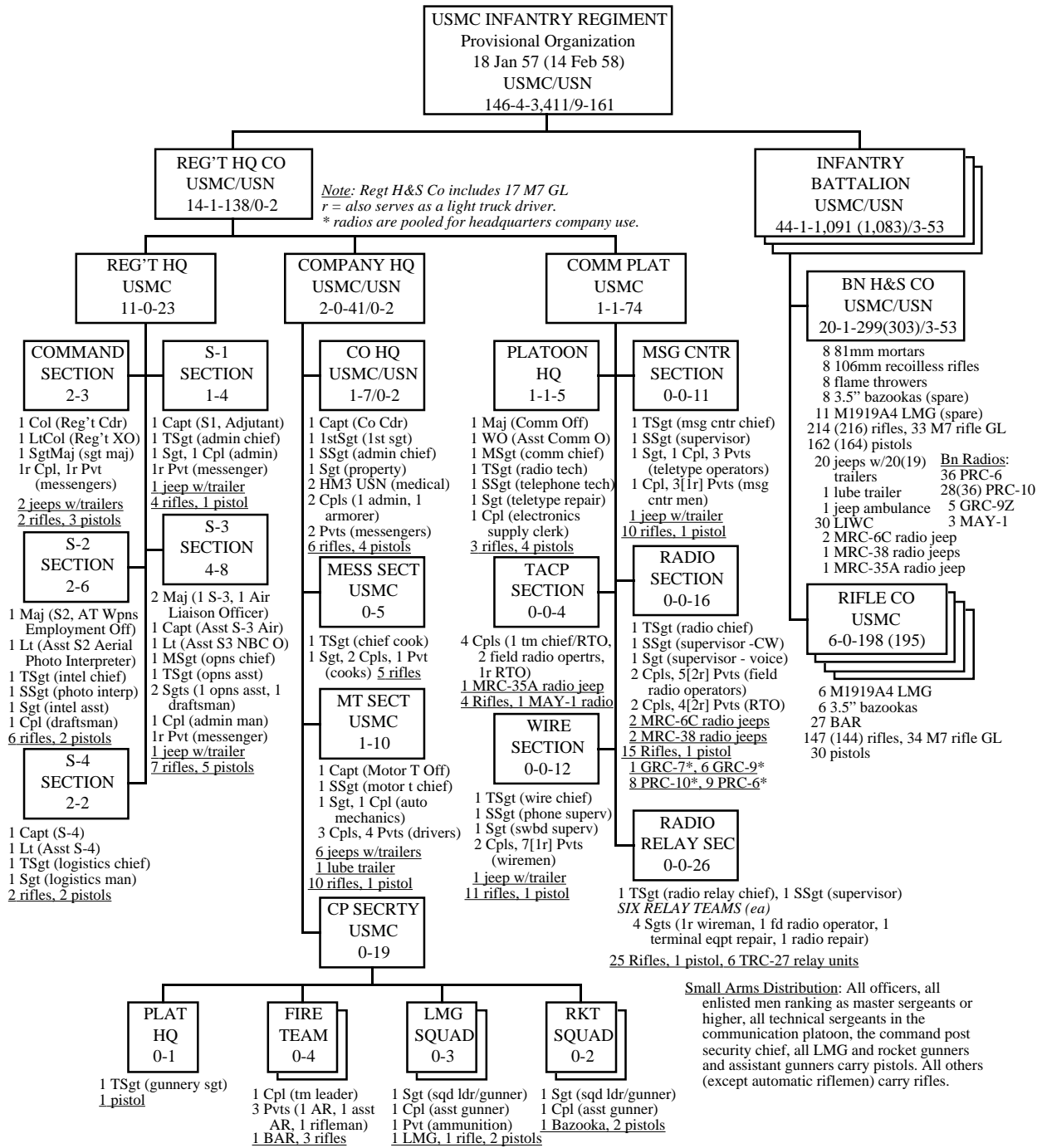

Notes:

**Communication Equipment:** Radios are listed in the diagram. See also the remarks under Appendix 8.17. Telephone (wire) equipment included five SB-22 switchboards, eight CE-11 reel equipments with phones and 35 EE-8 telephones. The message center included five AN/TGC-6 teletypewriter sets and an AN/GGC-3 reperforator teletypewriter set.

**Sources:** Marine Corps Provisional Table of Organization Prov-1038 "Infantry Battalion, Infantry Regiment, Marine Division, FMF" and Prov-1097 "Headquarters and Service Company, Infantry Regiment, Marine Division, FMF" (Washington DC dated 18 January 1957 and 14 February 1958, with Table of Equipment dated 14 February 1958).

## APPENDIX 9

### Appendix 9.1

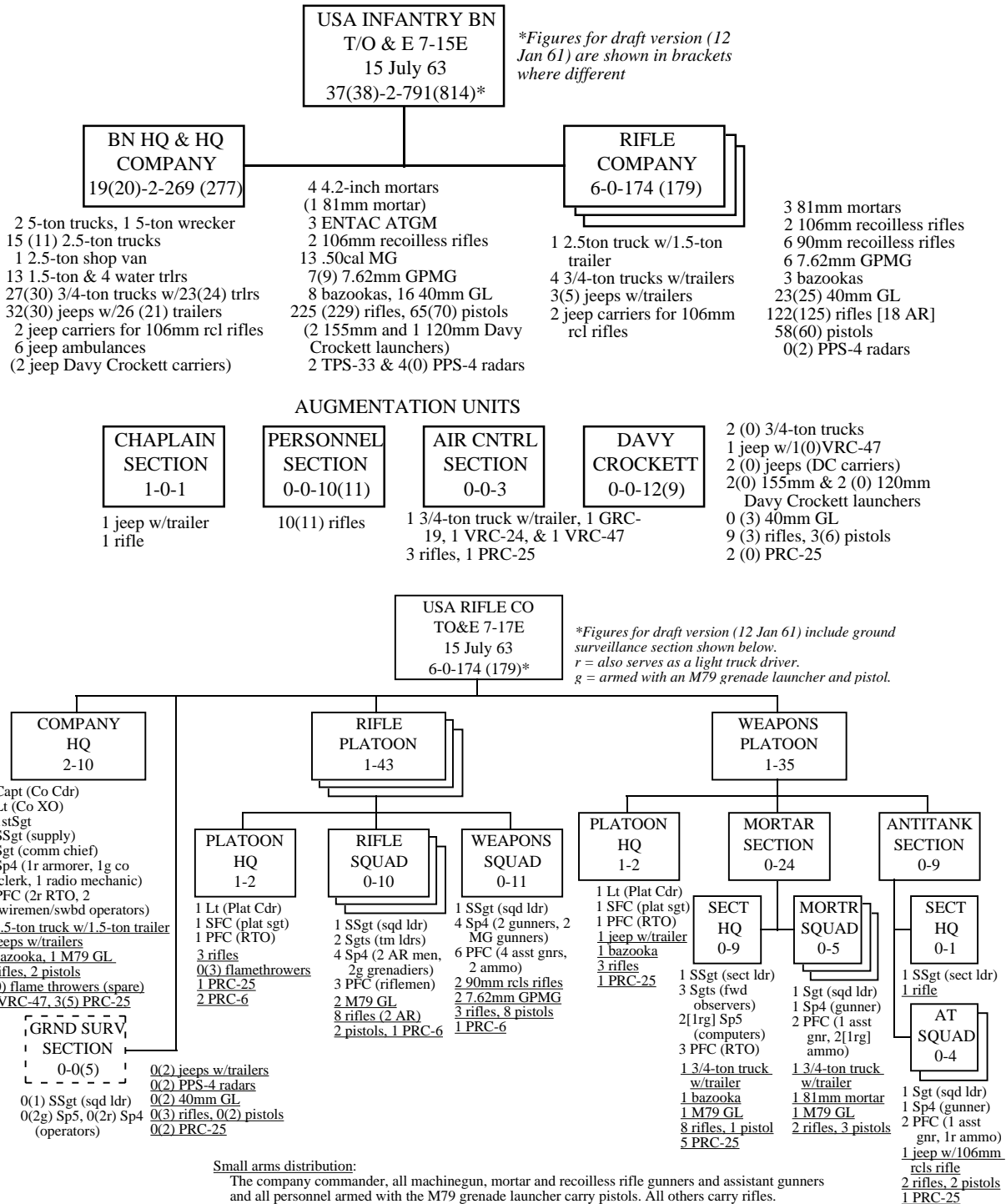

**Notes:**

**Sources:** Department of the Army Tables of Organization 7-15E "Infantry Battalion, Infantry Division" and 7-17E "Rifle Company, Infantry Battalion, Infantry Division" (Washington DC 12 January 1961 and 15 July 1963).

## Appendix 9.2

USA INFANTRY BN  
HQ & HQ COMPANY  
TO & E 7-16E  
15 July 63  
19(20)-2-269(277)\*

*\*Figures for draft version (12 Jan 61) are shown in brackets where different  
r = also acts as a light truck driver.  
g = armed with an M79 grenade launcher and a pistol.  
j = radio(s) mounted in jeep(s).  
q = radio(s) mounted in 3/4-ton truck(s).  
t = radio(s) mounted in 2.5-ton shop van.*

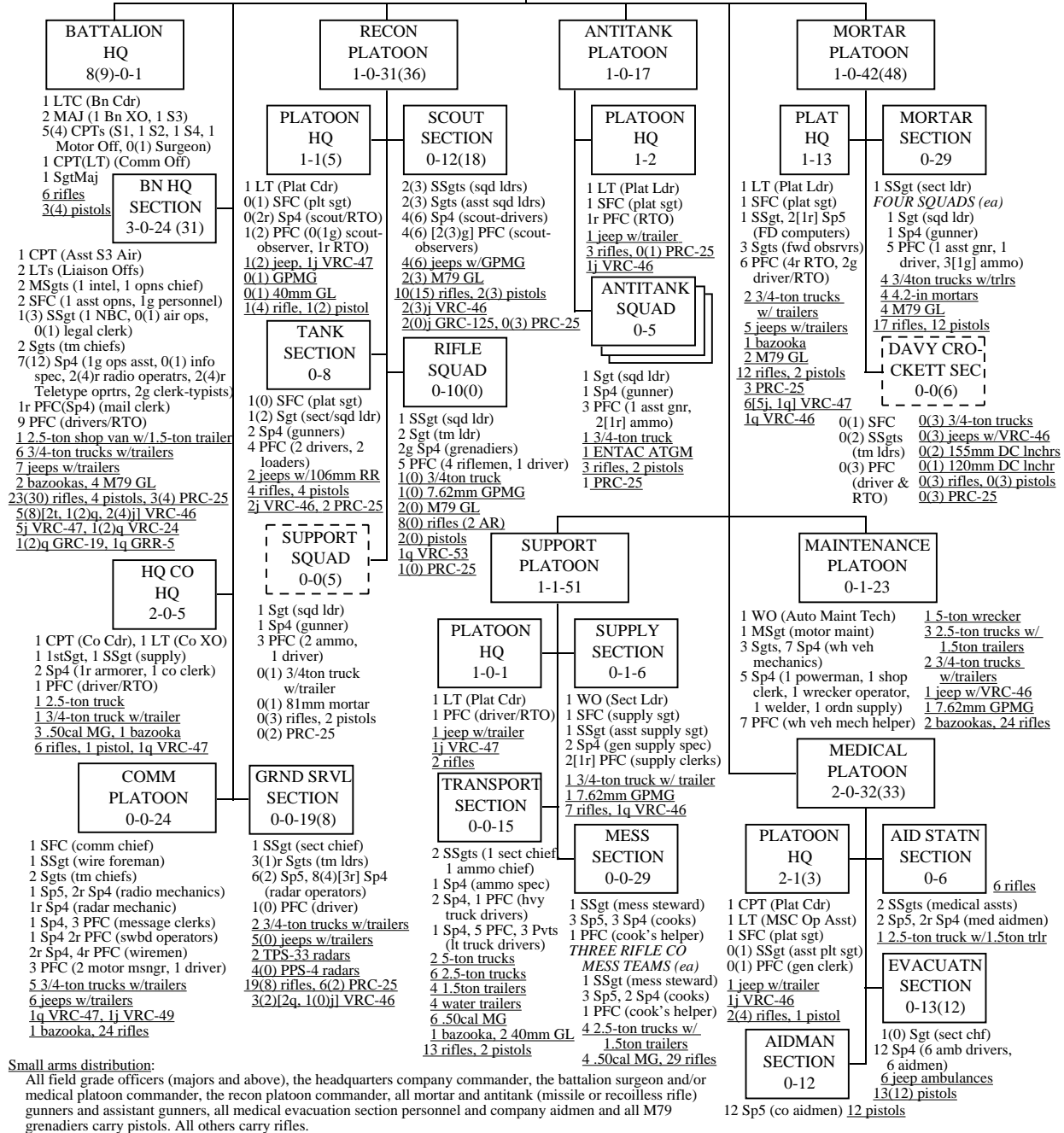

**Notes:**

**Source:** Department of the Army Table of Organization 7-16E "Headquarters and Headquarters Company, Infantry Battalion, Infantry Division" (Washington DC 12 January 1961 and 15 July 1963).

Appendix 9.3

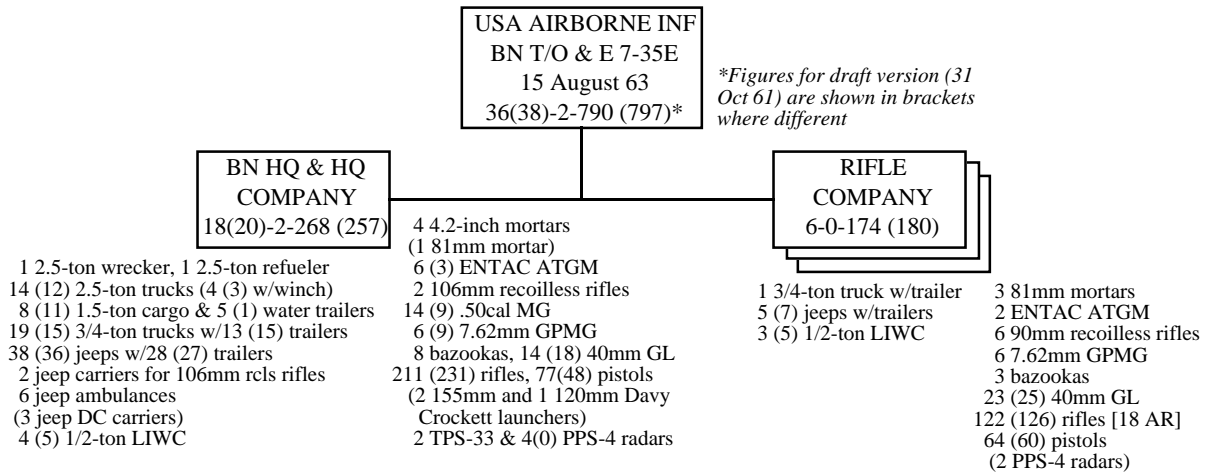

**AUGMENTATION UNITS**

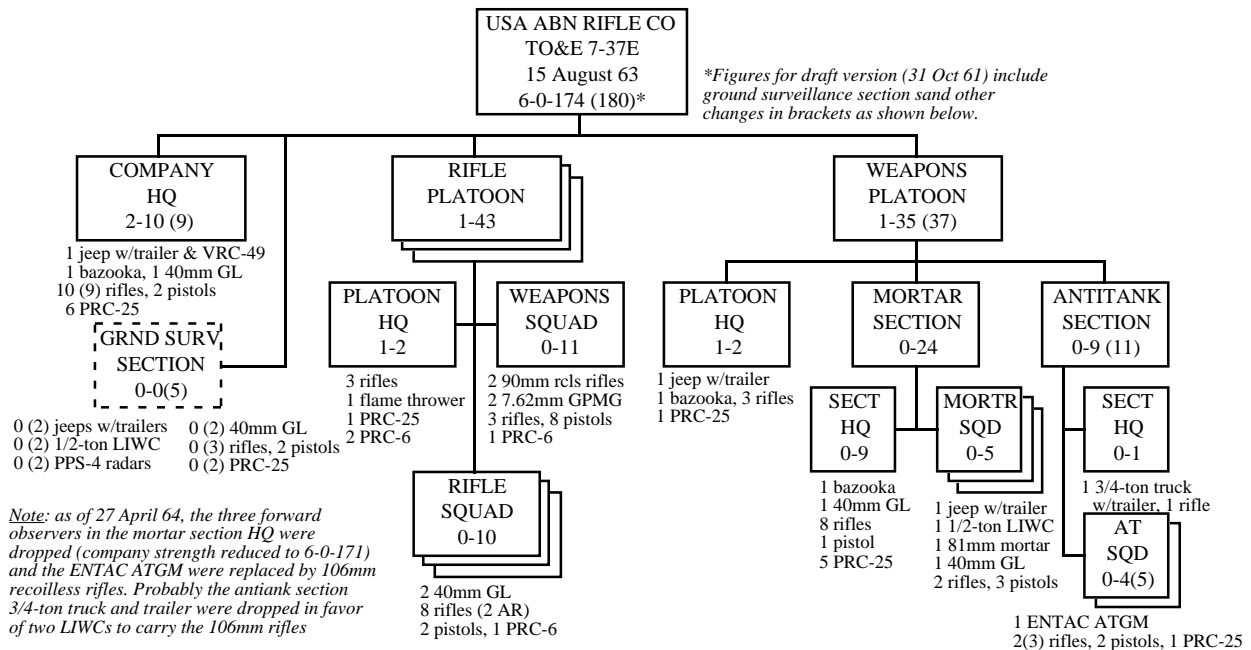
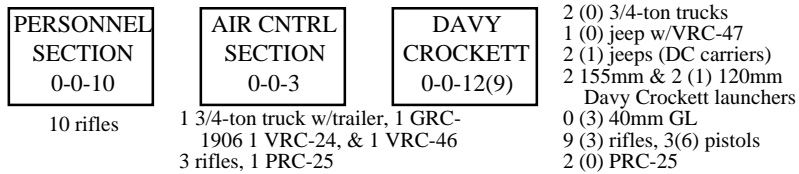

Appendix 9.3 (continued)

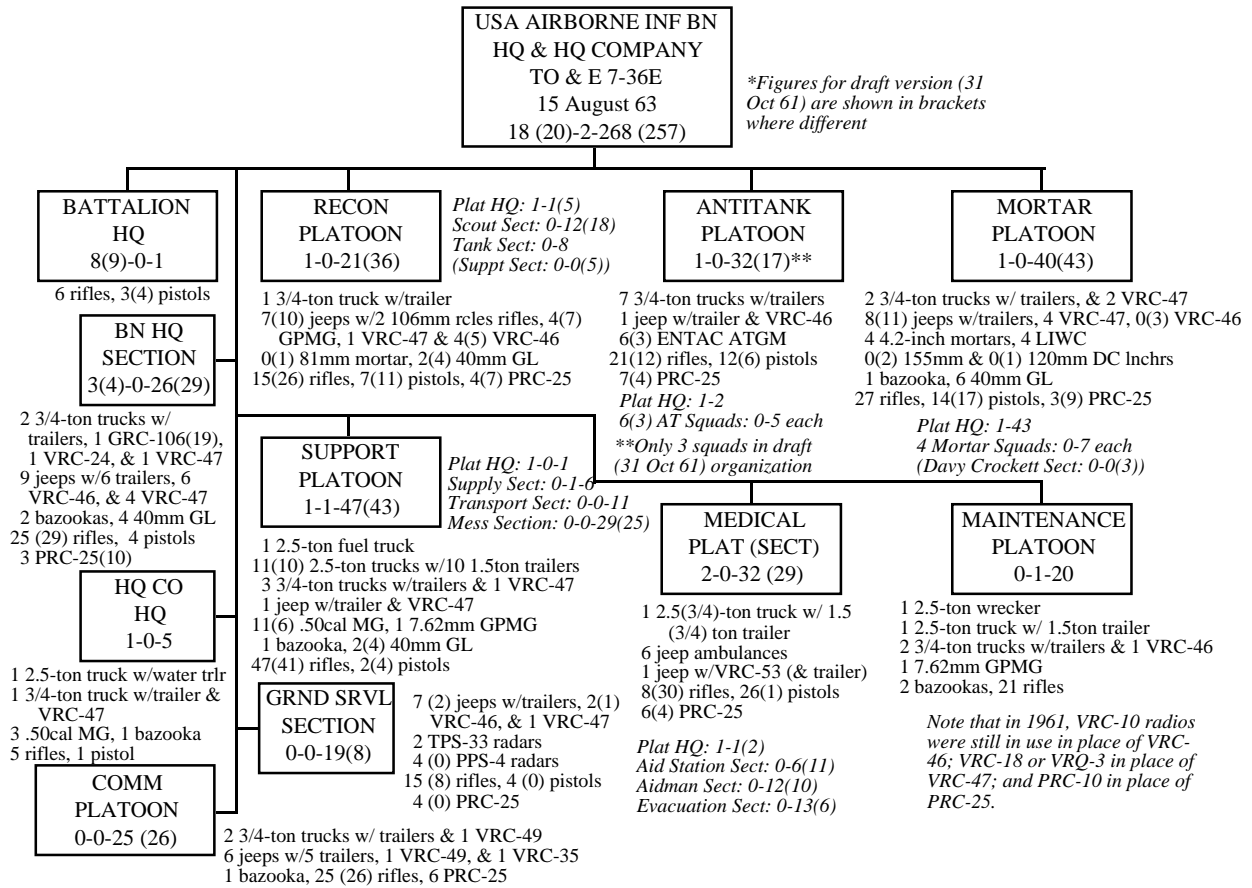

Notes:

Personnel ranks and duties are not shown since this organization was in force for only a short time.

Source: Department of the Army Tables of Organization 7-35E "Infantry Battalion, Airborne Division;" 7-36E "Headquarters and Headquarters Company, Infantry Battalion, Airborne Division" and 7-37E "Rifle Company, Infantry Battalion, Airborne Division" (Washington DC 31 October 1961 and 15 August 1963).

### Appendix 9.4

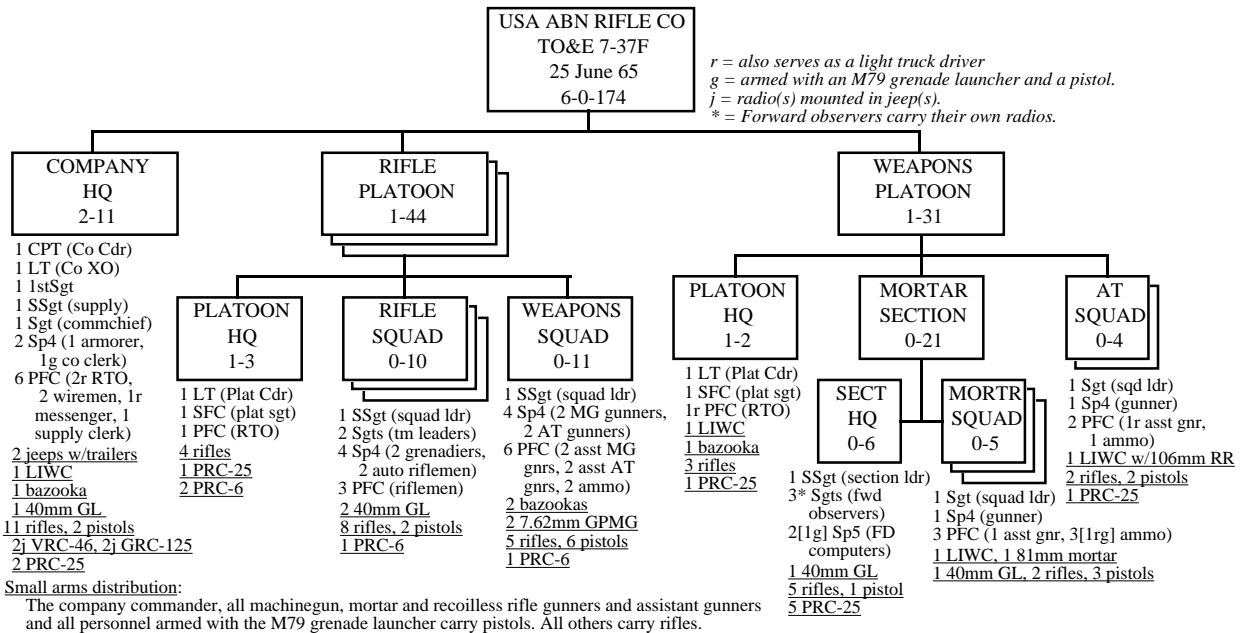
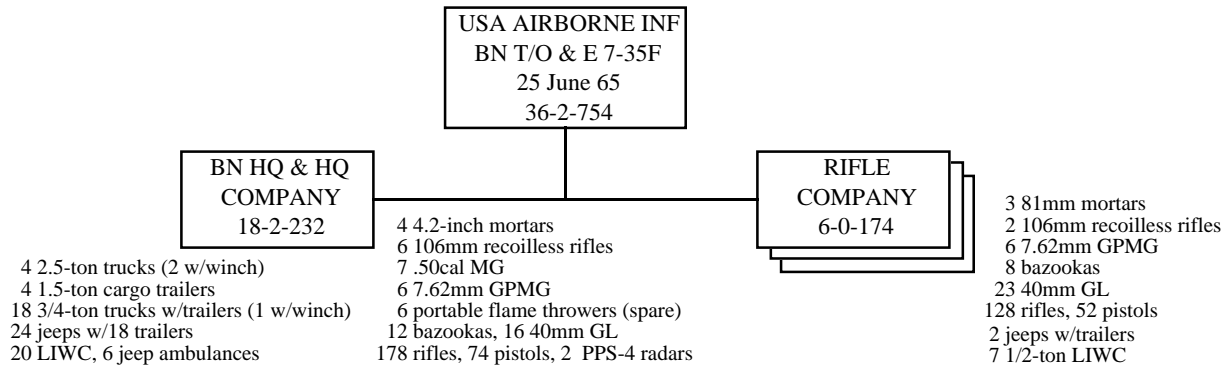

**Notes:**

**Source:** Department of the Army Tables of Organization 7-35F "Infantry Battalion, Airborne Division" and 7-37F "Rifle Company, Infantry Battalion, Airborne Division" (Washington DC 25 June 1965).

## Appendix 9.5

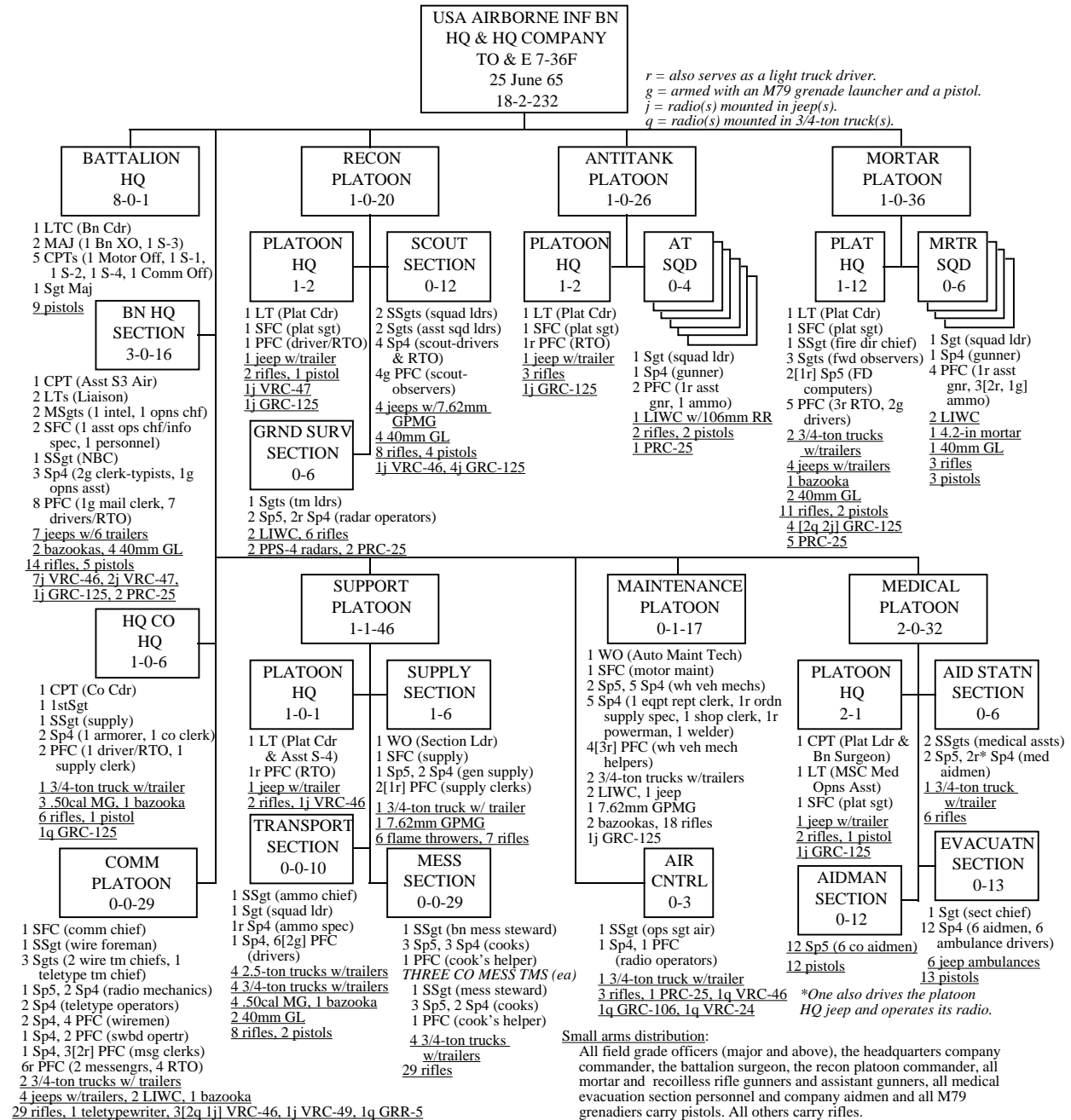

Notes:

Source: Department of the Army Table of Organization 7-36F "Headquarters and Headquarters Company Infantry Battalion, Airborne Division" (Washington DC 25 June 1965).



**Appendix 9.6**

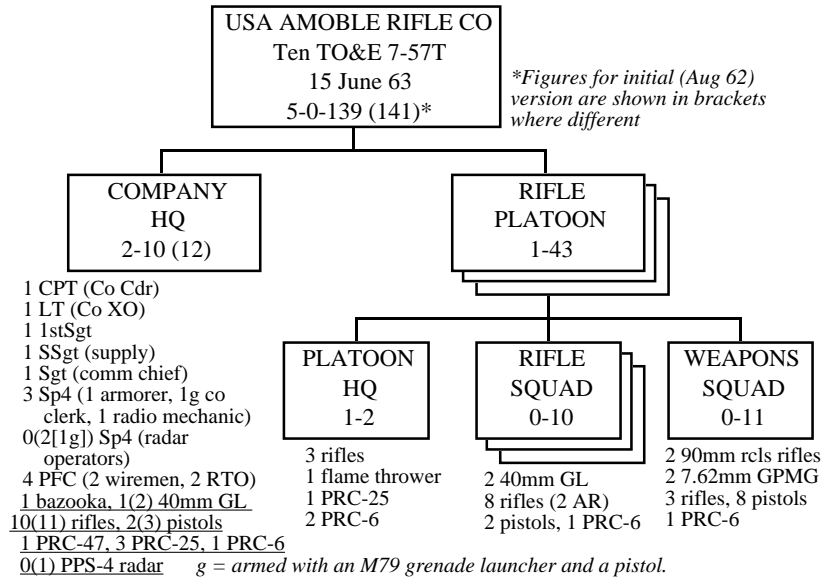
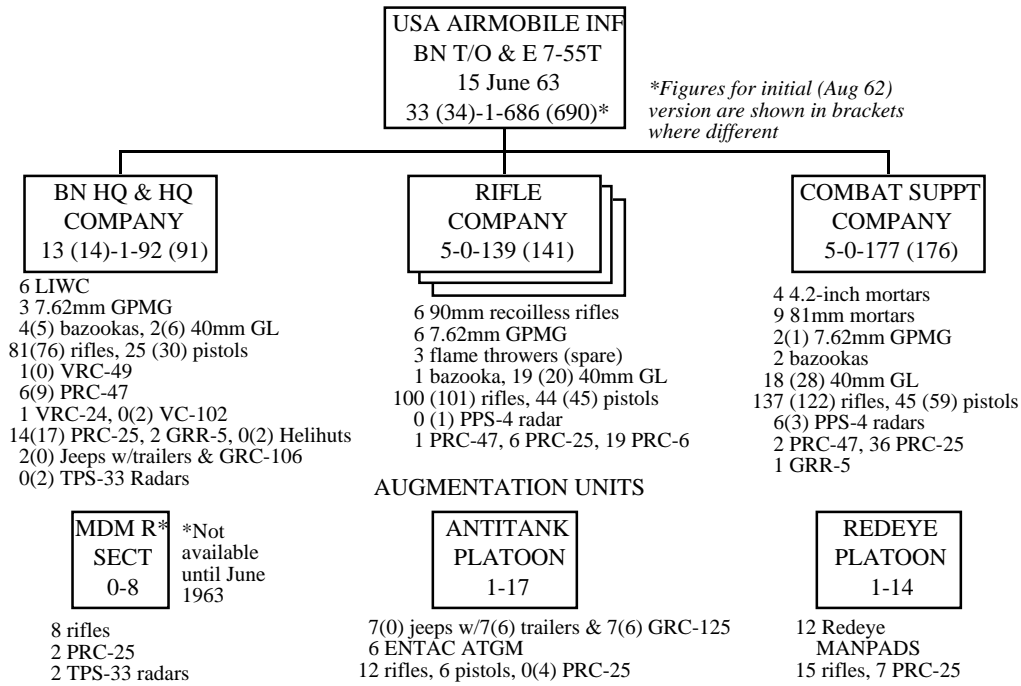

Appendix 9.6 (continued)

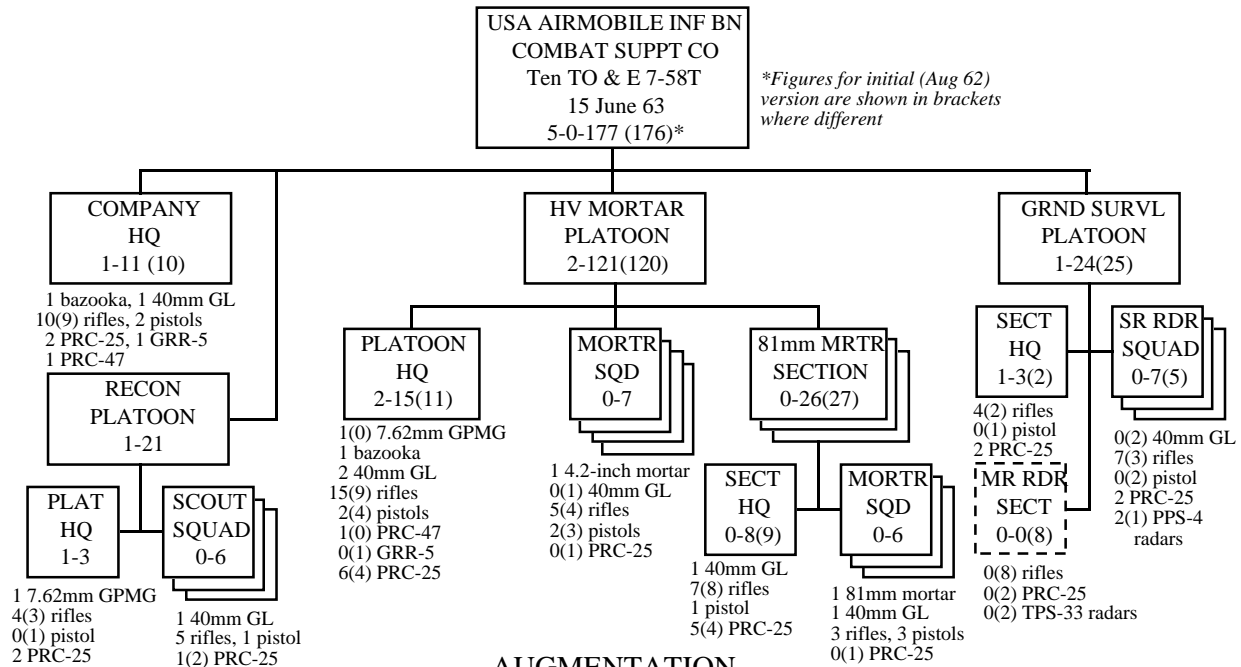

AUGMENTATION

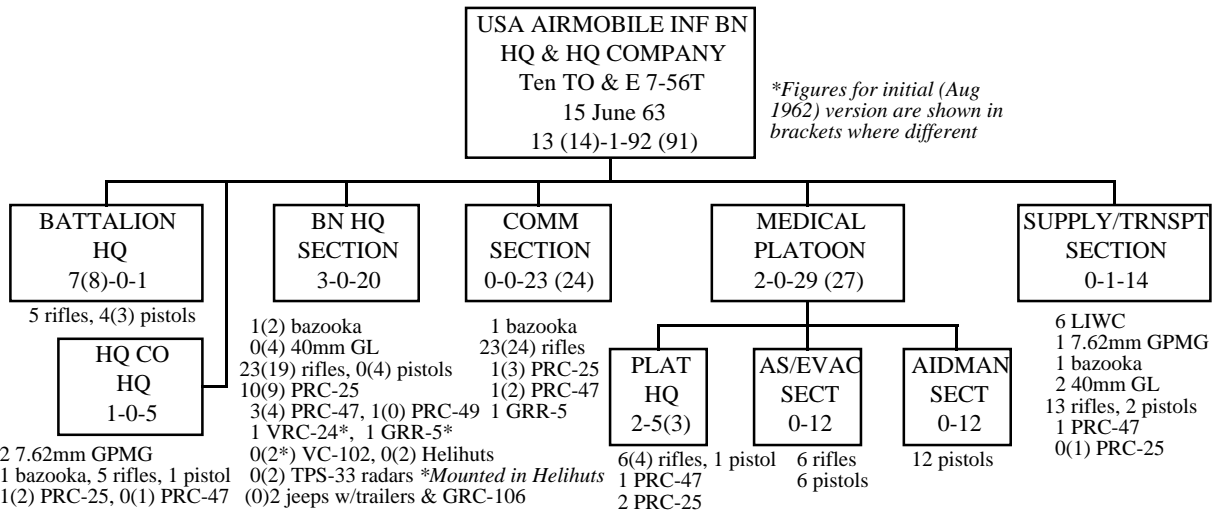
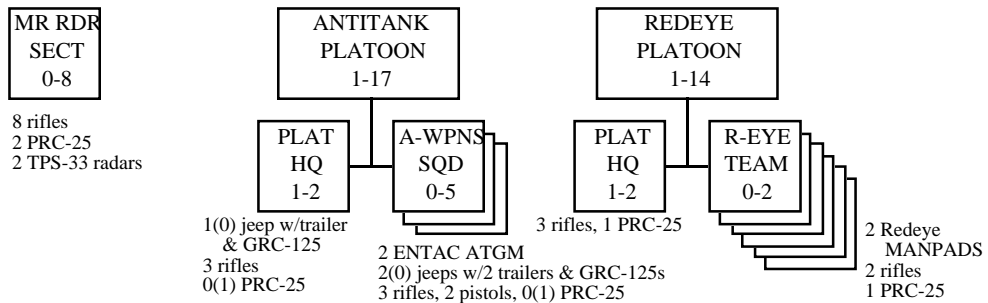

Notes:

Personnel ranks and duties are not shown since this organization was in force for only a short time.

Source: Department of the Army Tables of Organization 7-55T "Infantry Battalion, Air Assault Division;" 7-36T "Headquarters and Headquarters Company, Infantry Battalion, Air Assault Division;" 7-57E "Rifle Company, Infantry Battalion, Air Assault Division" and 7-58T "Combat Support Company, Infantry Battalion, Air Assault Division" (Washington DC undated papers probably from about August of 1962 and (a dated version with changes) 15 June 1963).

Appendix 9.7

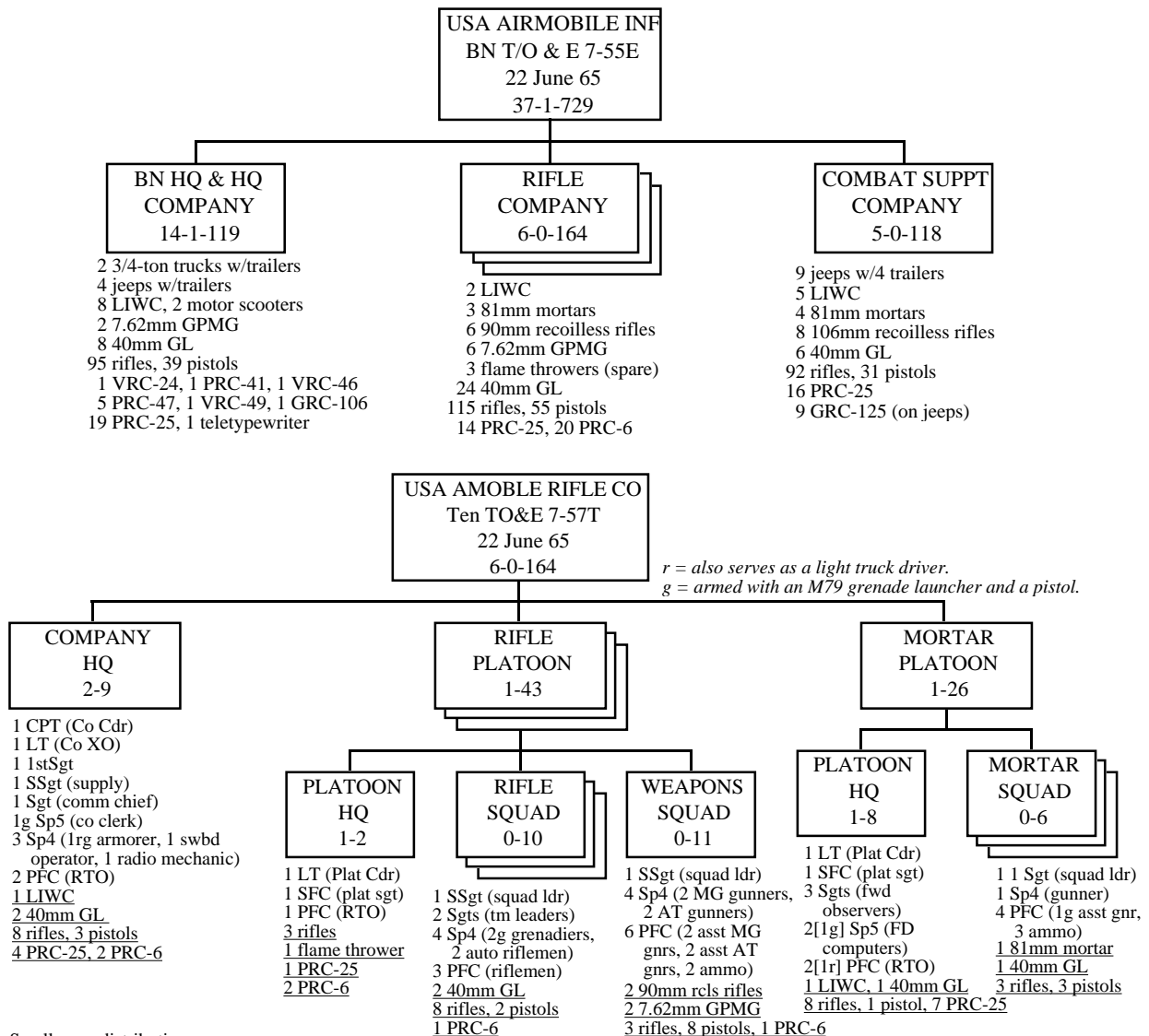

Small arms distribution:

The company commander, all machinegun and antitank gunners and assistant gunners, mortar squad leaders and gunners and all personnel armed with the M79 grenade launcher carry pistols. All others carry rifles.

Notes:

Source: Department of the Army Tables of Organization 7-55T "Infantry Battalion, Air Assault Division" and 7-57F "Rifle Company, Infantry Battalion, Air Assault Division" (Washington DC 22 June 1965).

## Appendix 9.8

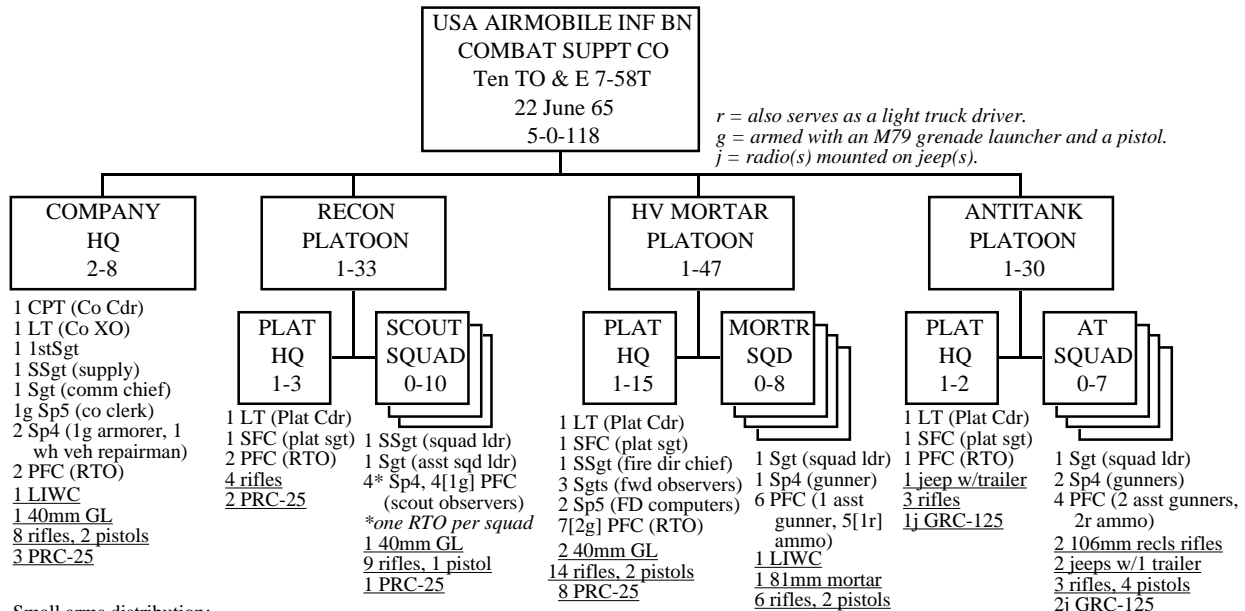

**Small arms distribution:**

The company commander, all mortar and antitank gunners and assistant gunners and all personnel armed with the M79 grenade launcher carry pistols. All others carry rifles.

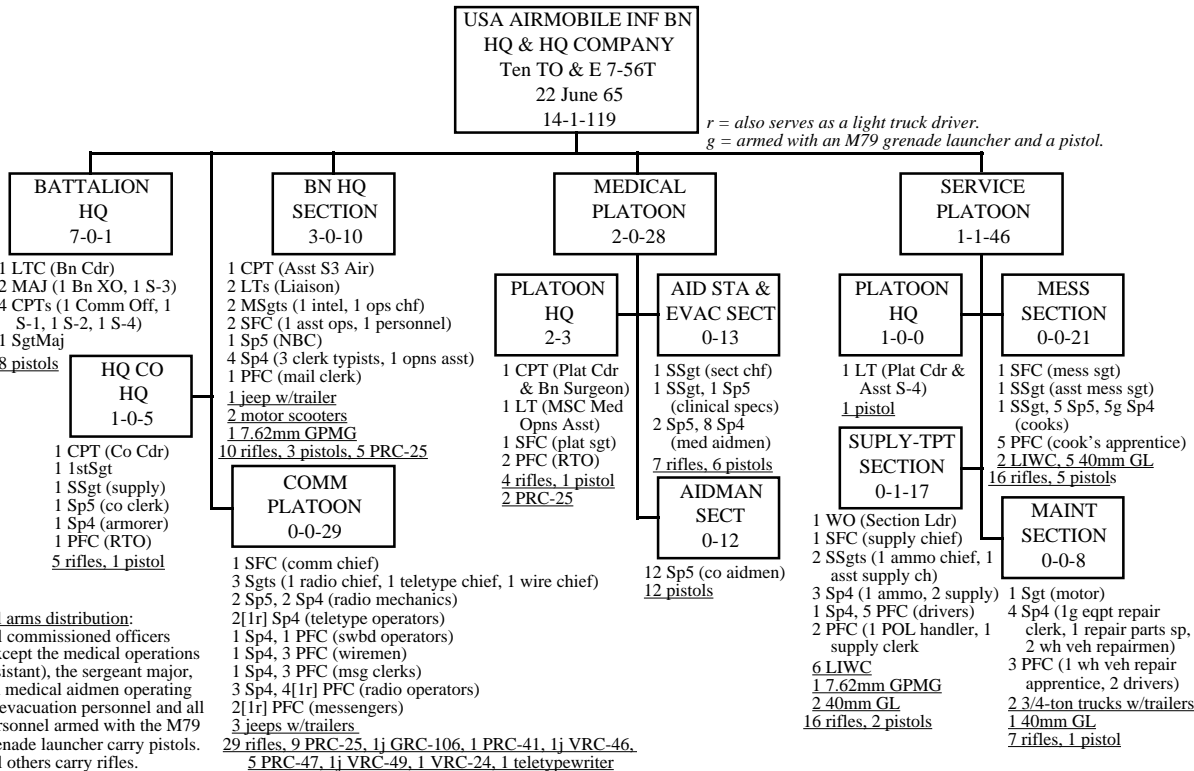

**Small arms distribution:**

All commissioned officers (except the medical operations assistant), the sergeant major, six medical aidmen operating as evacuation personnel and all personnel armed with the M79 grenade launcher carry pistols. All others carry rifles.

**Notes:**

**Source:** Department of the Army Tables of Organization 7-56T "Headquarters and Headquarters Company, Infantry Battalion, Air Assault Division" and 7-58F "Combat Support Company, Infantry Battalion, Air Assault Division" (Washington DC 22 June 1965).

### Appendix 9.9

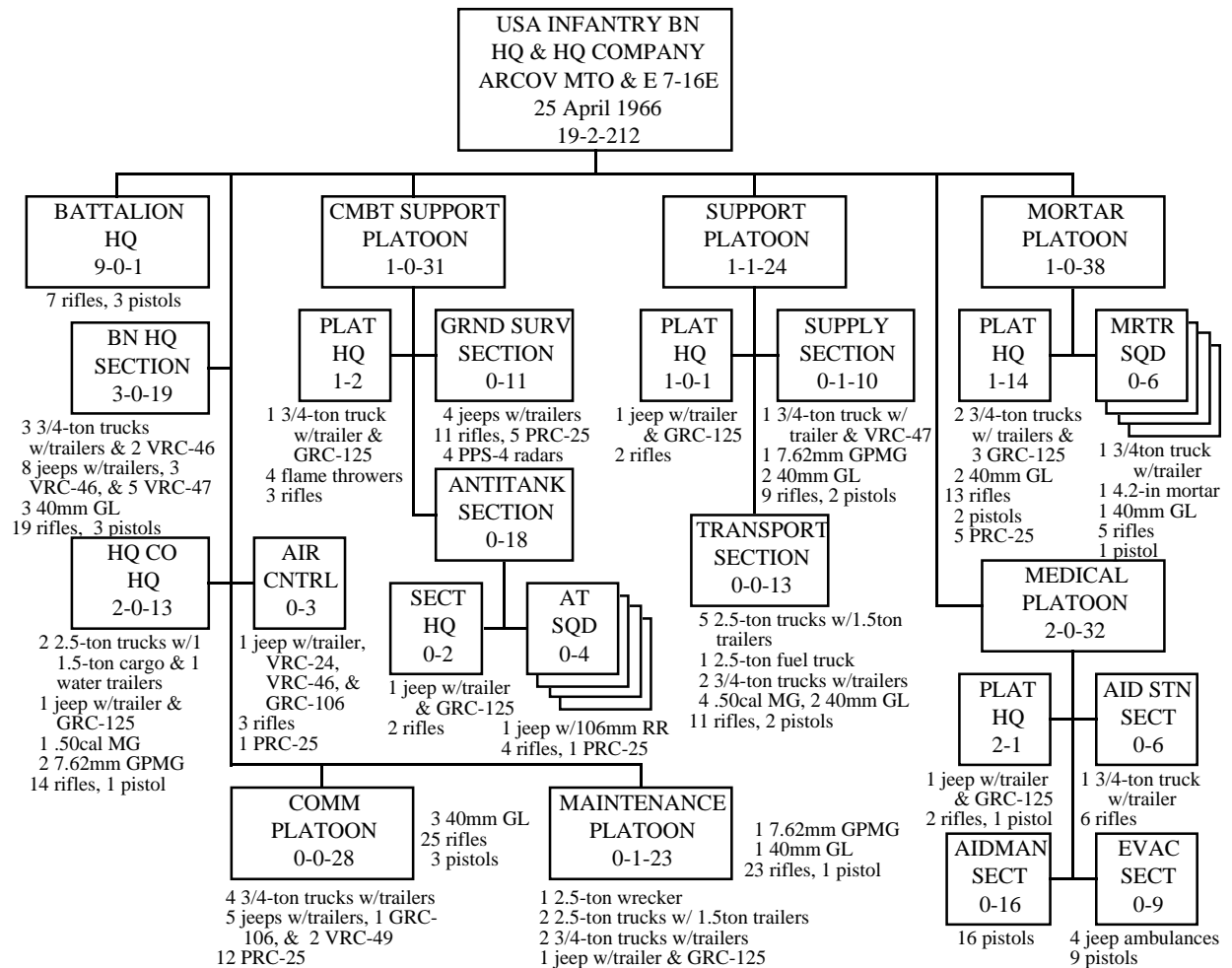
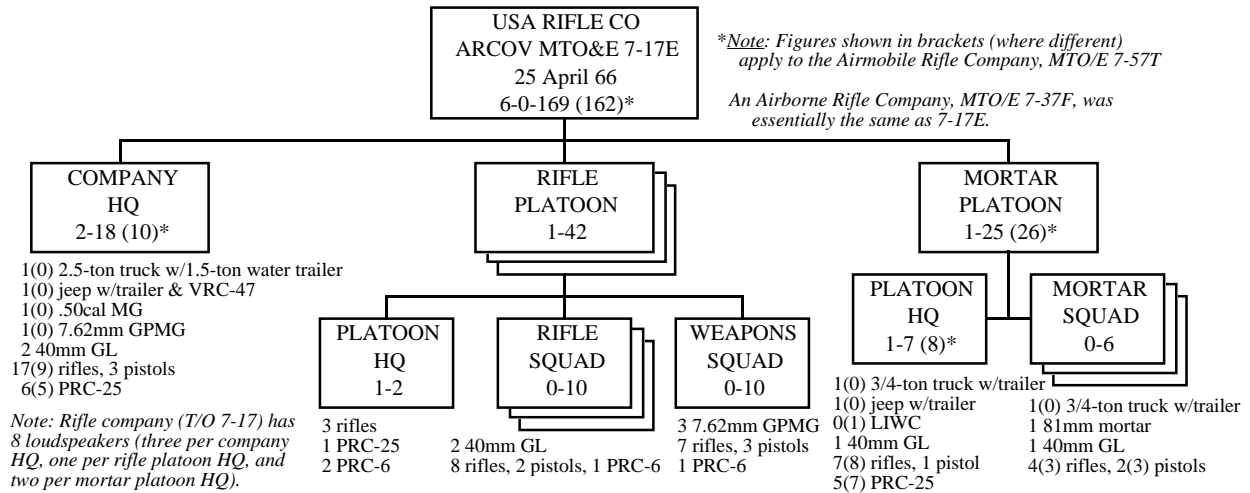

Notes:

Source: ARCOV Study 25 April 1966, Annex H, MTOE 7-16E and MTOE 7-17E.

Appendix 9.10

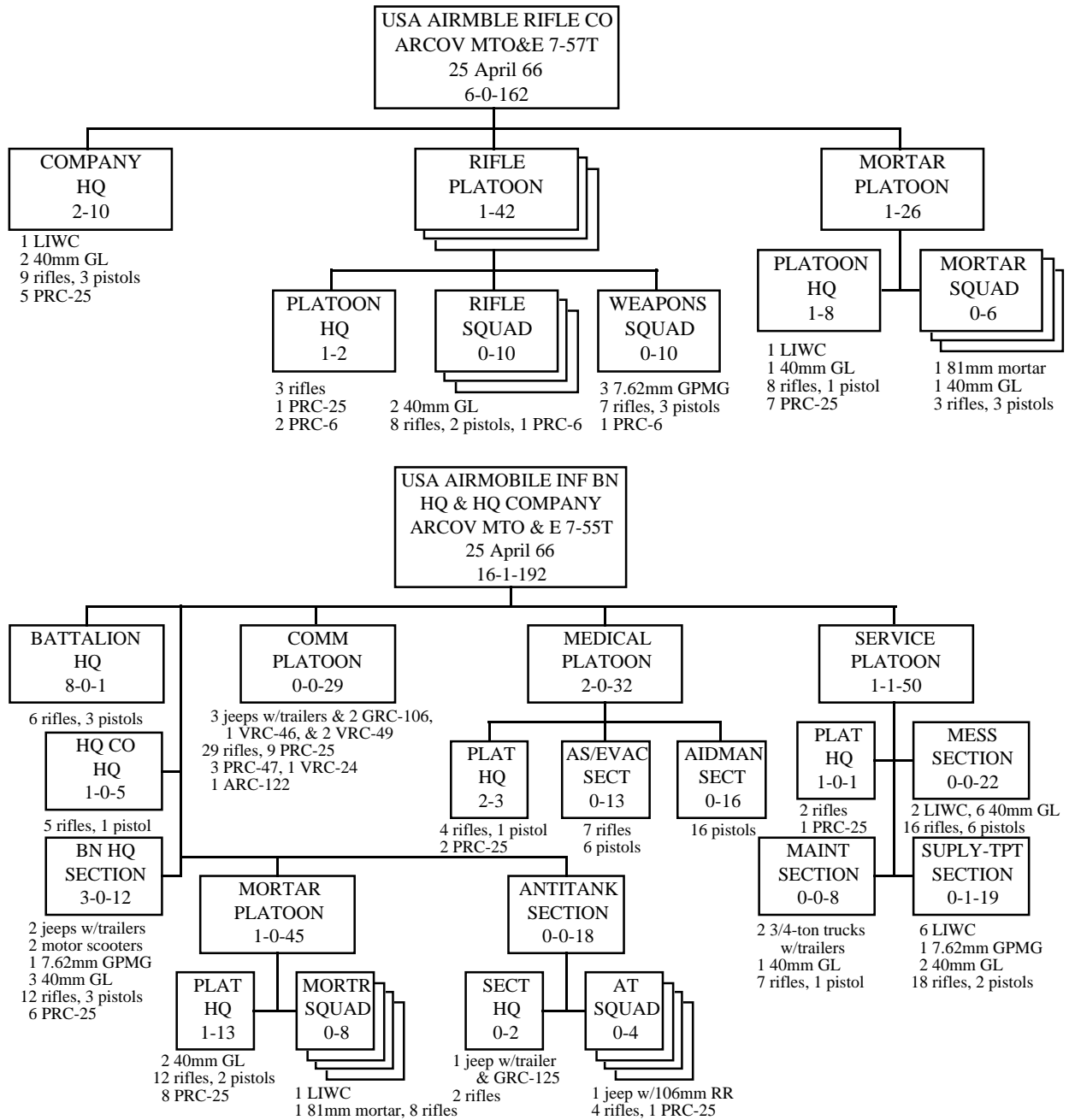

Notes

Sources: ARCOV Study 25 April 1966, Annex H, MTOE 7-56T and MTOE 7-57T.

**Appendix 9.11**

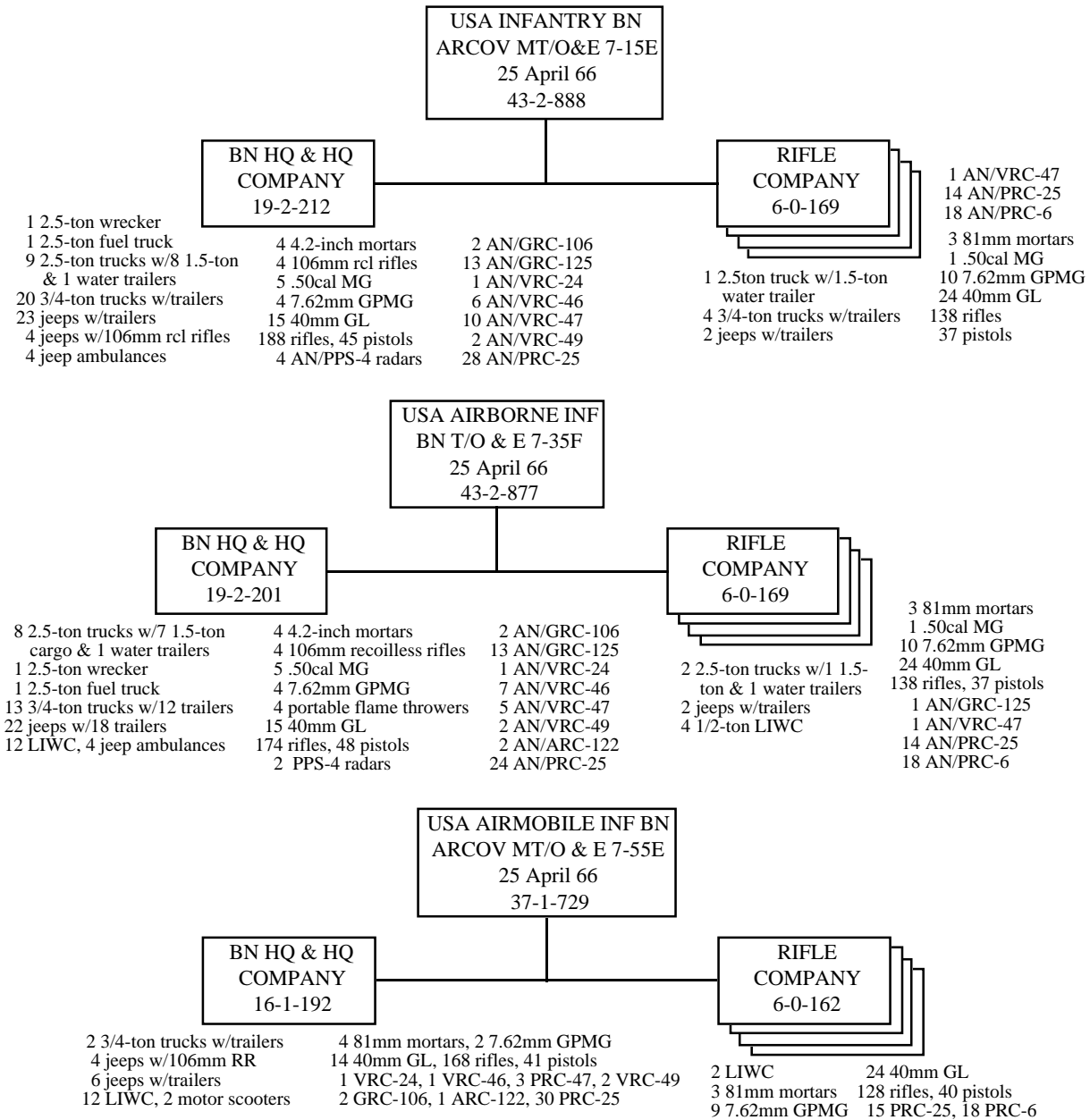

Notes:

Sources: ARCOV Study 25 April 1966, Annex H, MTOE 7-15E, MTOE 7-35F and MTOE 7-55T.

Appendix 9.12

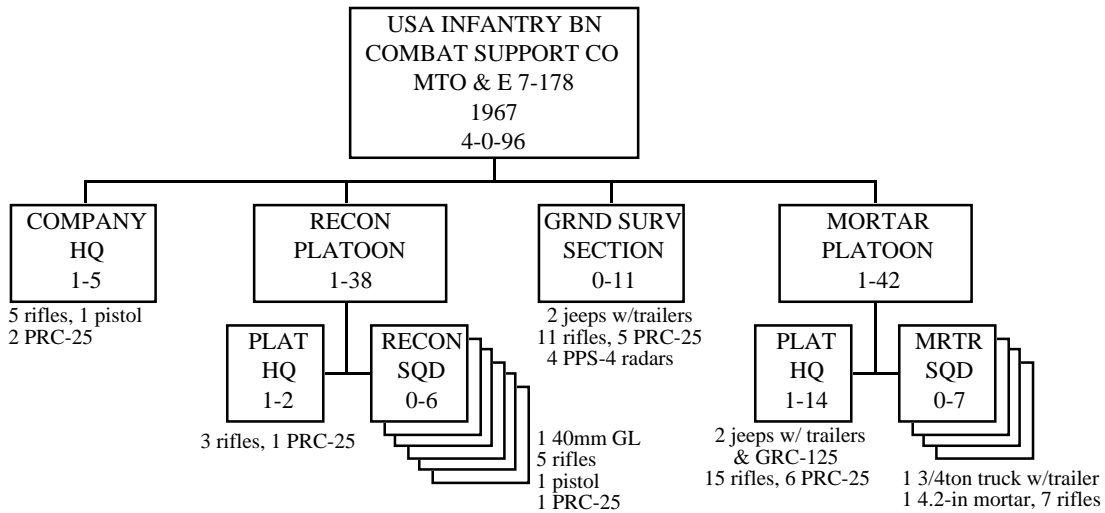
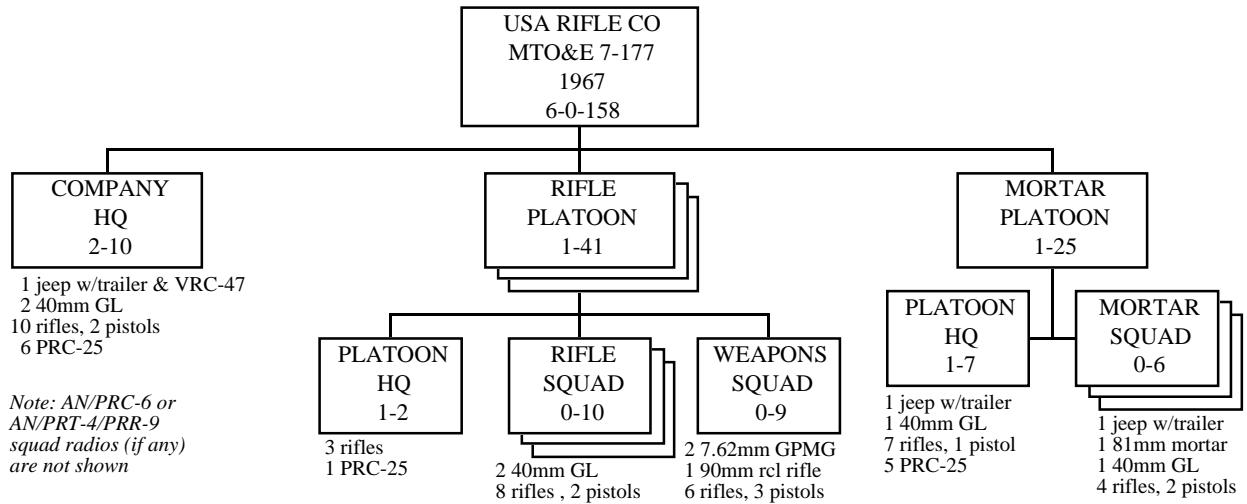



Appendix 9.12 (continued)

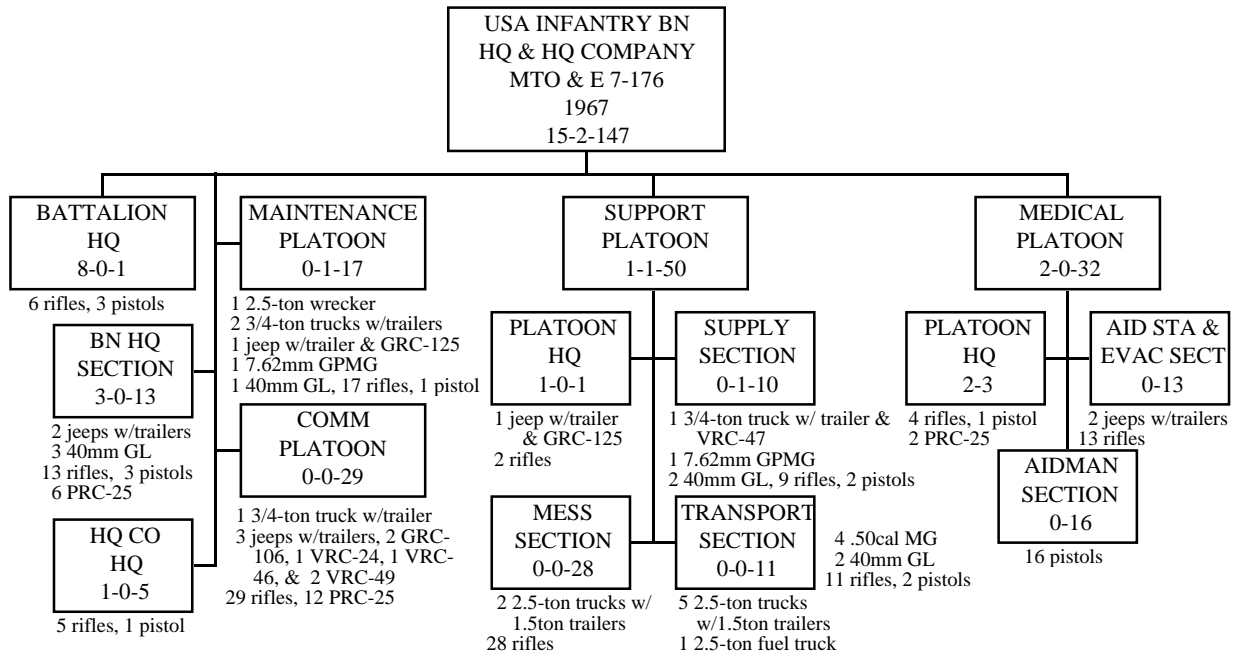

Notes:

Source: US Army MTOE 7-176 "Headquarters and Headquarters Company, Infantry Battalion (Test);" 7-177 "Rifle Company, Infantry Battalion (Test)" and 7-178 "Combat Support Company, Infantry Battalion (Test)" all dated ca 1966 and quoted in Shelby L. Stanton, *Vietnam Order of Battle* op cit p.53.

Appendix 9.13

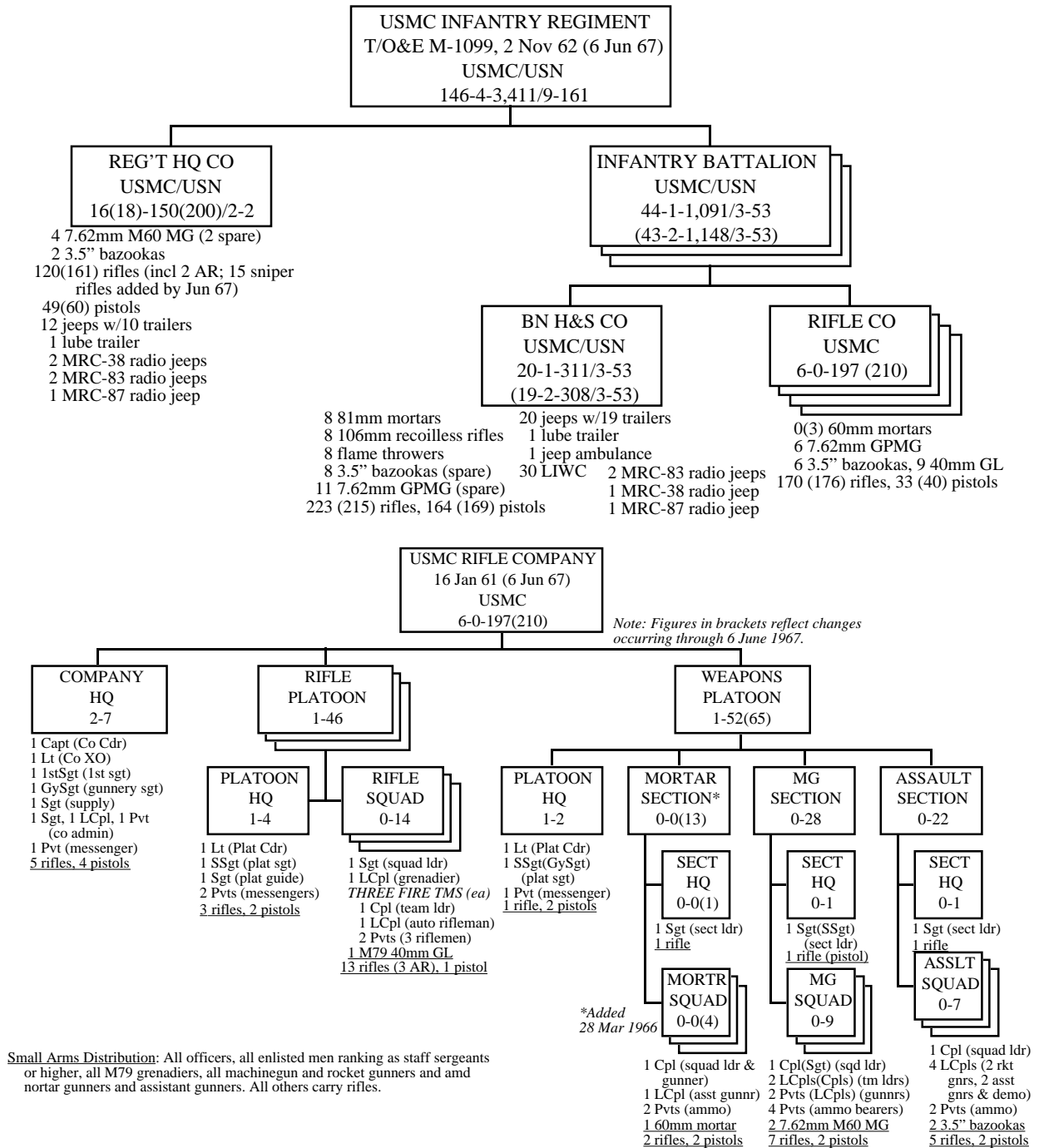

Notes:

Source: Marine Corps Tables of Organization M-1013 "Rifle Company, Infantry Battalion, Infantry Regiment, Marine Division, FMF;" M-1038 "Infantry Battalion, Infantry Regiment, Marine Division, FMF;" and M-1099 "Infantry Regiment, Marine Division, FMF;" (Washington DC dated 16 January 1961 with updates through 6 June 1967).

## Appendix 9.14

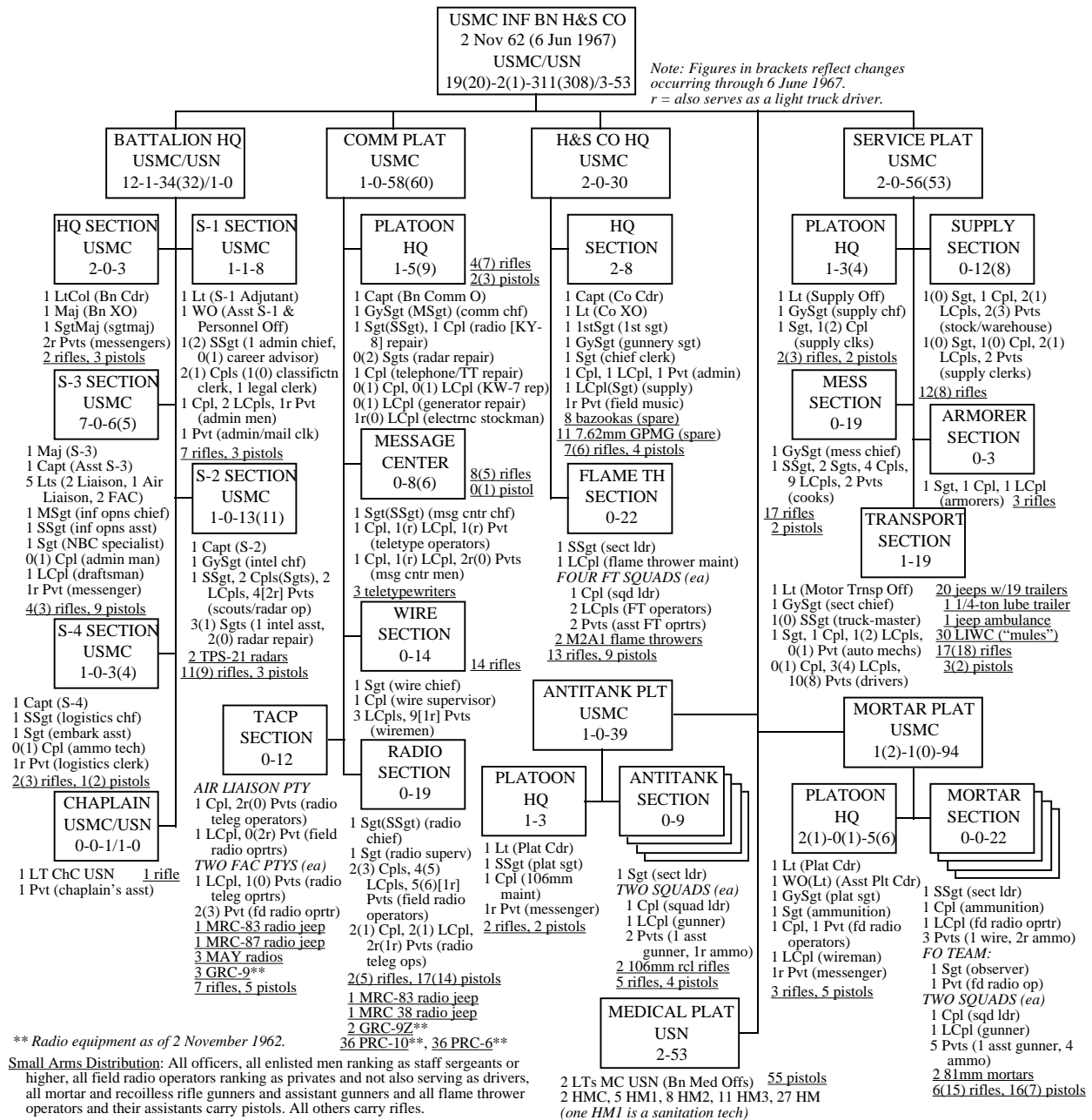

**Notes:**

**Communication Equipment:** The equipment shown in the diagram is what was authorized in November 1962. There were numerous changes after that but this writer has not been able to uncover either a table of equipment or a reliable listing of principal equipment dated prior to 1979-80. However, some information is available. The new AN/PRC-25 replaced the AN/PRC-10 series radios in the mid-to-late 1960s. Battalions in Vietnam usually received 22 additional AN/PRC-25 in lieu of their AN/PRC-6. Seven of these appear to have been in the AN/GRC-125 configuration. The AN/PRC-41 replaced the MAY as the standard man-pack ground-to-air radio in the mid-1960s. The AN/PRC-47 also replaced the AN/GRC-9 as the battalion's long-range portable radio. Prior to 1974 the communication platoon replaced its AN/MRC-38 jeep with two longer-ranged AN/MRC-109 and two AN/MRC-134. The AN/MRC-134 mounted the same radio set as the AN/MRC-109 but also had an AN/VCC-1 telegraph-telephone terminal set. The wire section's equipment included five SB-22 switchboard systems.

**Radar Equipment:** The AN/PPS-6 had replaced the AN/TPS-21 prior to 1974.

**Source:** Marine Corps Table of Organization M-1037 "Headquarters and Service Company, Infantry Battalion, Infantry Regiment, Marine Division, FMF" (Washington DC dated 16 January 1961 with updates through 6 June 1967).

## Appendix 9.15

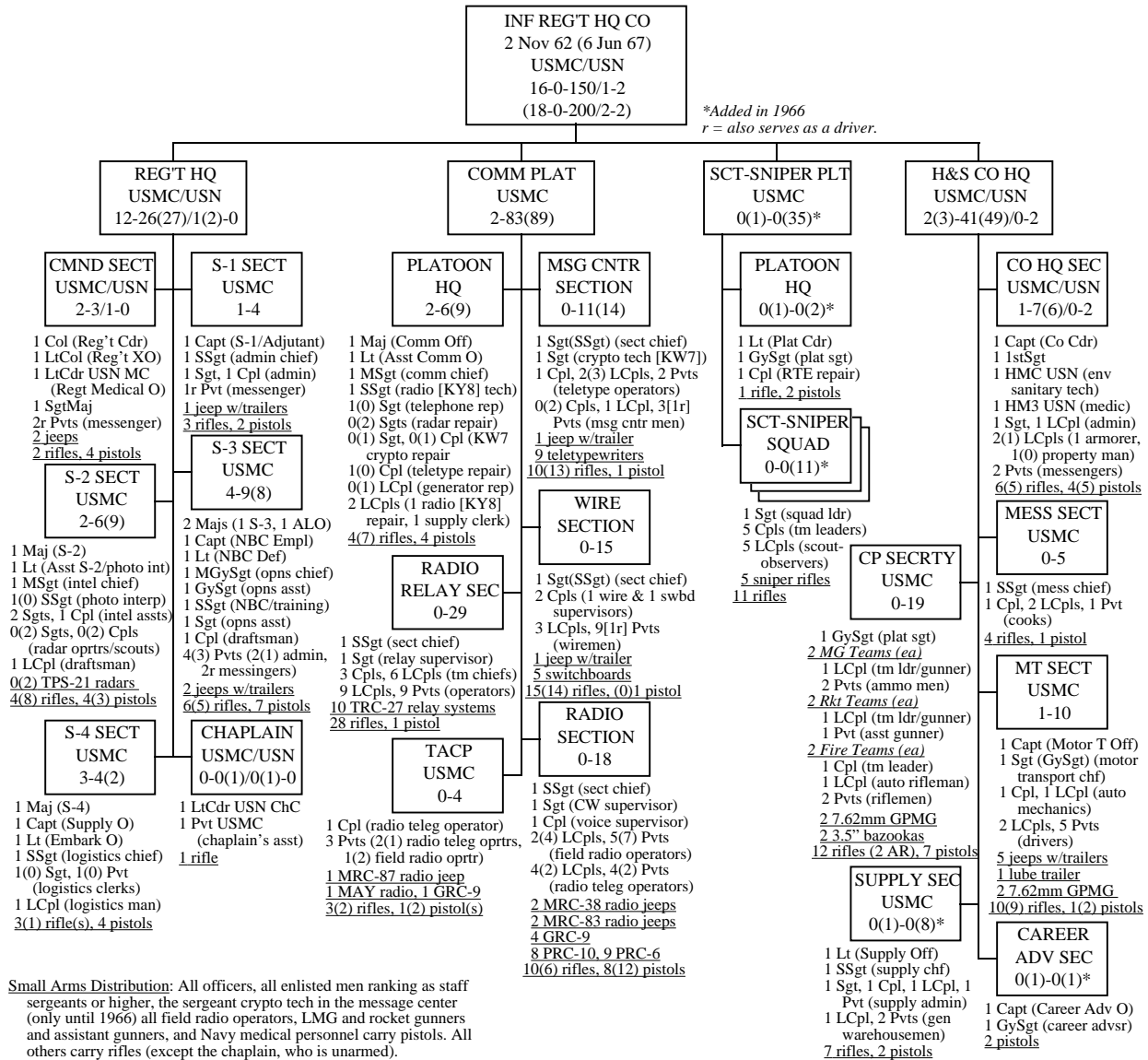

**Notes:**

**Communication Equipment:** See the comments under Appendix 9.14. Ten AN/PRC-25 and three AN/GRC-125 replaced the AN/PRC-10 and AN/PRC-6 radios shown above during the mid-to-late 1960s. The AN/PRC-47 also replaced the AN/GRC-9. Two AN/MRC-110 (similar to the AN/MRC-109 but with two receiver-transmitters rather than one and one receiver) replaced the two AN/MRC-38 radio jeeps. In addition the communication platoon acquired two AN/MRC-134 and eight AN/MRC-135 jeeps (a huge increase). The AN/MRC-135 was the same as the AN/MRC-134 except that it could handle twice as many telegraph/telephone channels (eight rather than four). In the TACP section two AN/PRC-41 replaced the MAY.

**Sources:** Marine Corps Table of Organization M-1096 "Headquarters Company, Infantry Regiment, Marine Division, FMF (Washington DC dated 16 January 1961 with updates through 6 June 1967). For information on Marine radio equipment see Marine Corps Technical Manual TM-2000-15A Volume II "Principal Characteristics of US Marine Corps Communication-Electronic Equipment (Headquarters US Marine Corps Washington DC 12 November 1975).

## APPENDIX 10

### Appendix 10.1

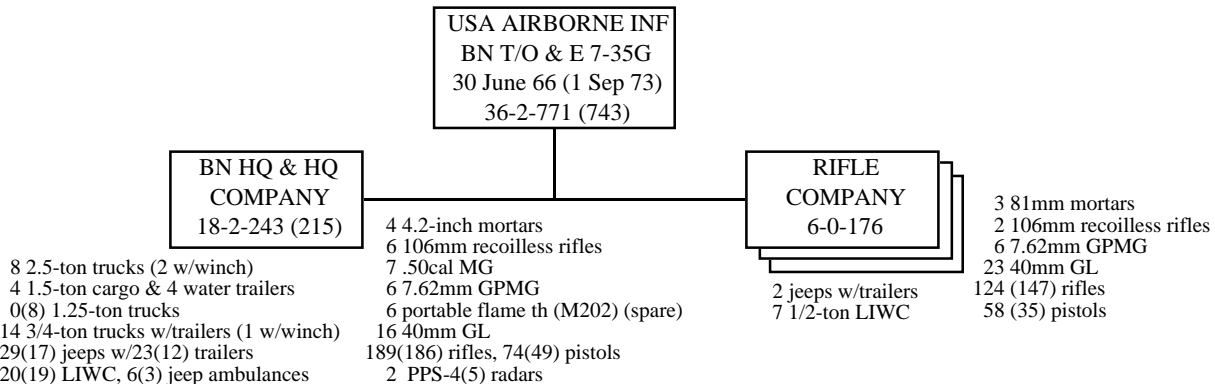
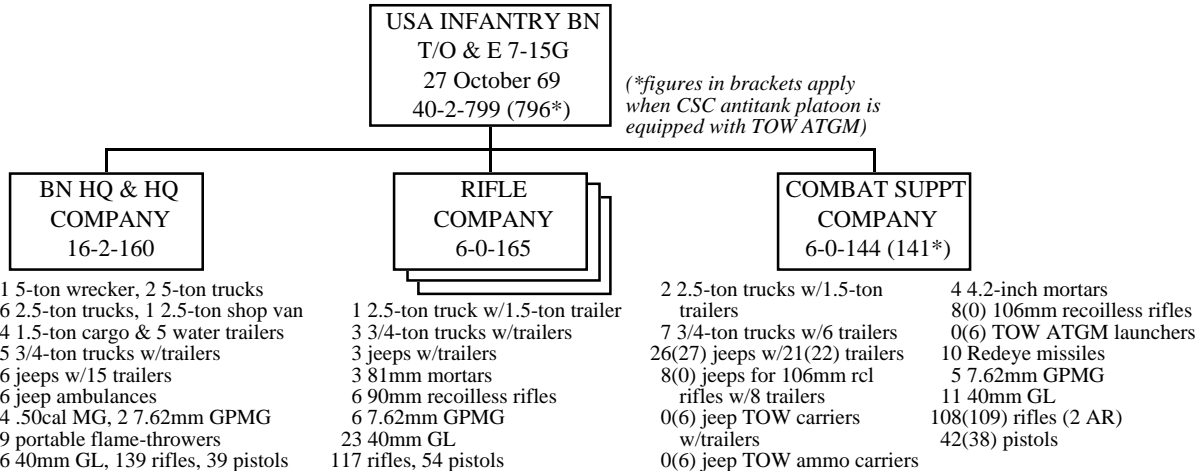
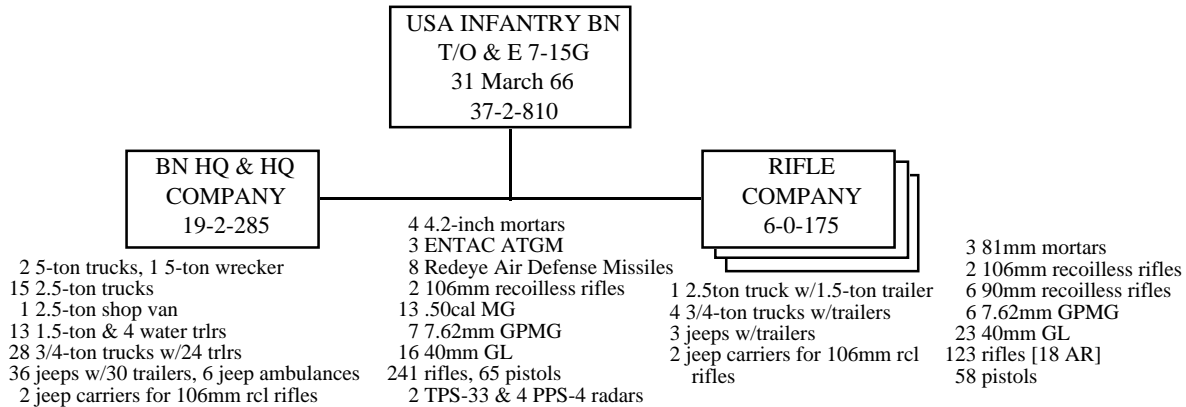

Notes:

Source: Department of the Army Table of Organization 7-15G "Infantry Battalion, Infantry Division or Separate Infantry Brigade" (Washington DC 31 March 1966 and 27 October 1969) and 7-35G "Infantry Battalion (Airborne), Airborne Division or Separate Airborne Brigade" (Washington DC 30 June 1966 plus changes to 1 September 1973).

**Appendix 10.2**

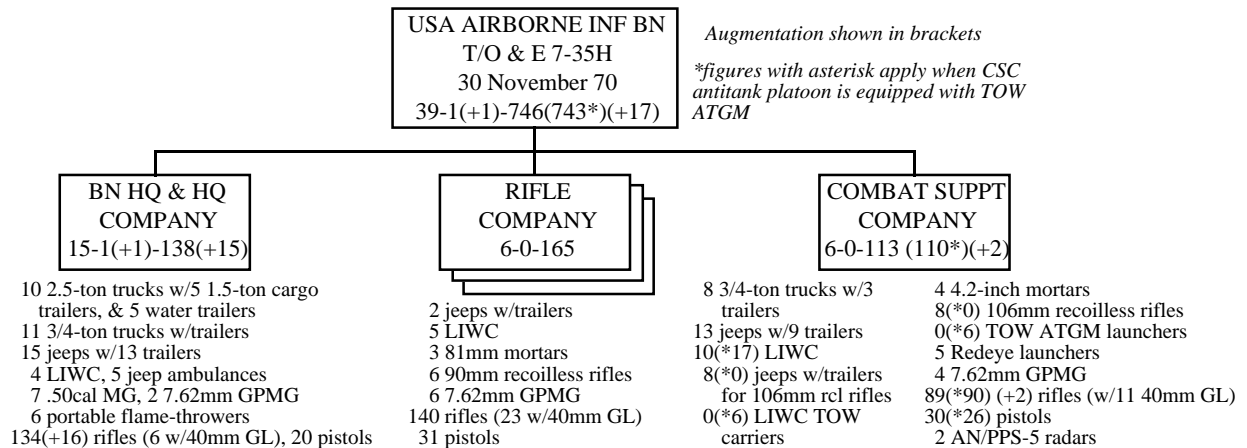
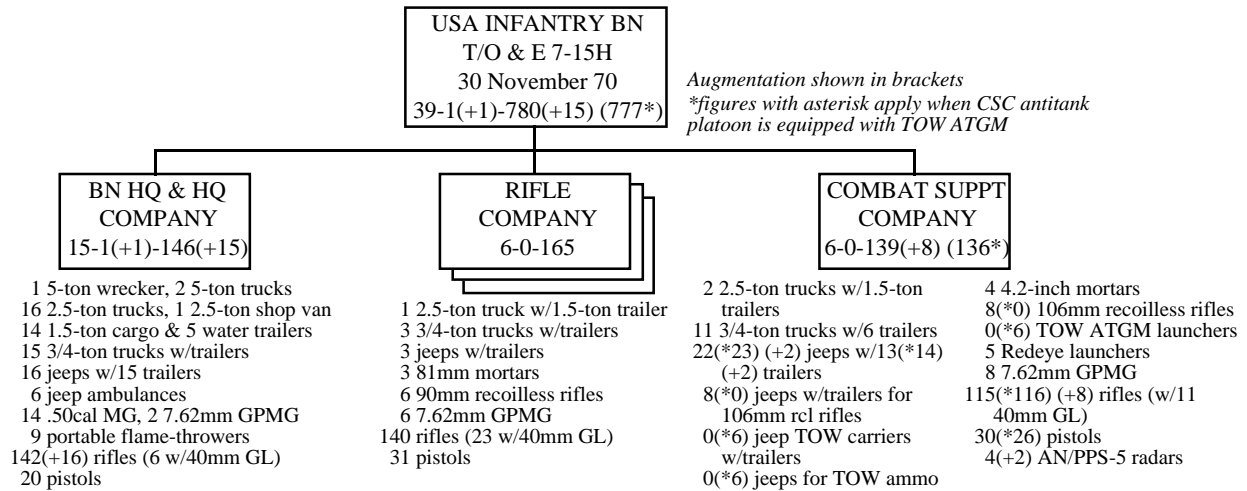

Notes:

Sources: Department of the Army Tables of Organization 7-15H "Infantry Battalion, Infantry Division or Separate Infantry Brigade" and 7-35H "Infantry Battalion (Airborne), Airborne Division or Separate Airborne Brigade" (Washington DC 30 November 1970).

### Appendix 10.3

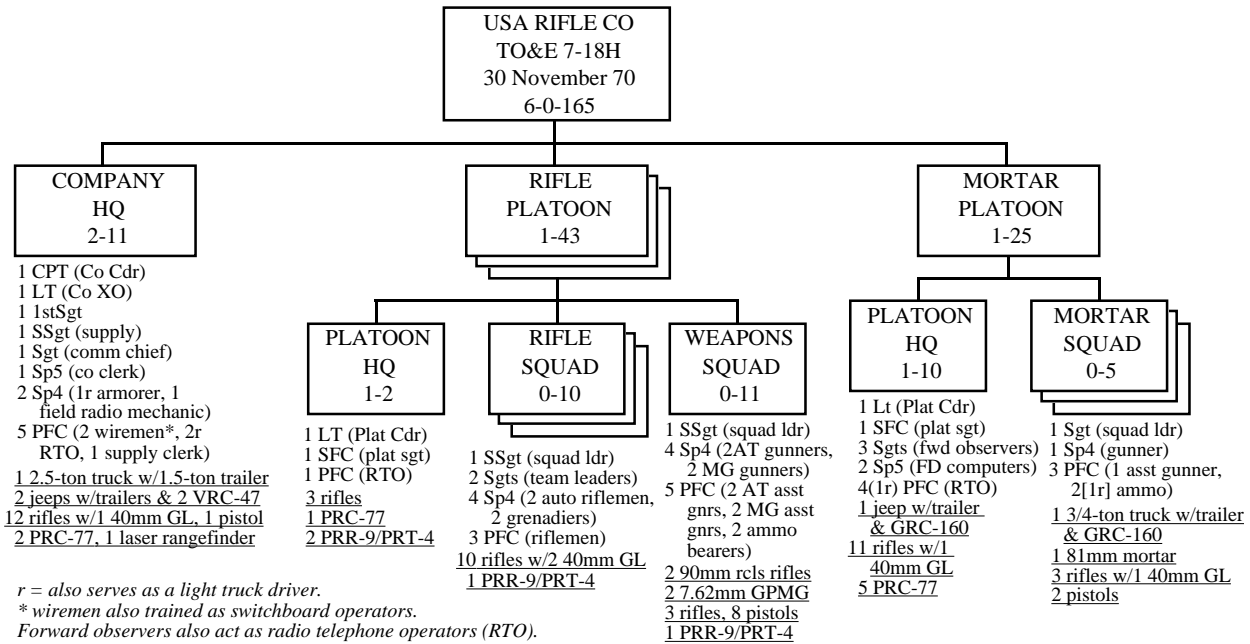

**Small Arms Distribution:** Pistols issued the company commander and all machinegun, mortar and antitank gunners and assistant gunners. All other personnel carry rifles but the tables do not specify which ones (apart from the rifle grenadiers) carry M203 40mm grenade launchers on their weapons. Presumably, this was left to the discretion of the company commander.

**Notes:**

An airborne rifle company (TO&E 7-37H) was the same except that the mortar platoon used four LIWC and four additional AN/PRC-77 man-pack radios rather than a jeep and three 3/4-ton trucks with AN/GRC-160 radios. The airborne company headquarters had the same two jeeps as a rifle company but only had an LIWC in lieu of a 2.5-ton truck (see TO&E 7-36H dated 30 November 1970).

**Source:** Department of the Army Table of Organization 7-18H "Rifle Company, Infantry Battalion, Infantry Division or Separate Infantry Brigade" (Washington DC 30 November 1970).

## Appendix 10.4

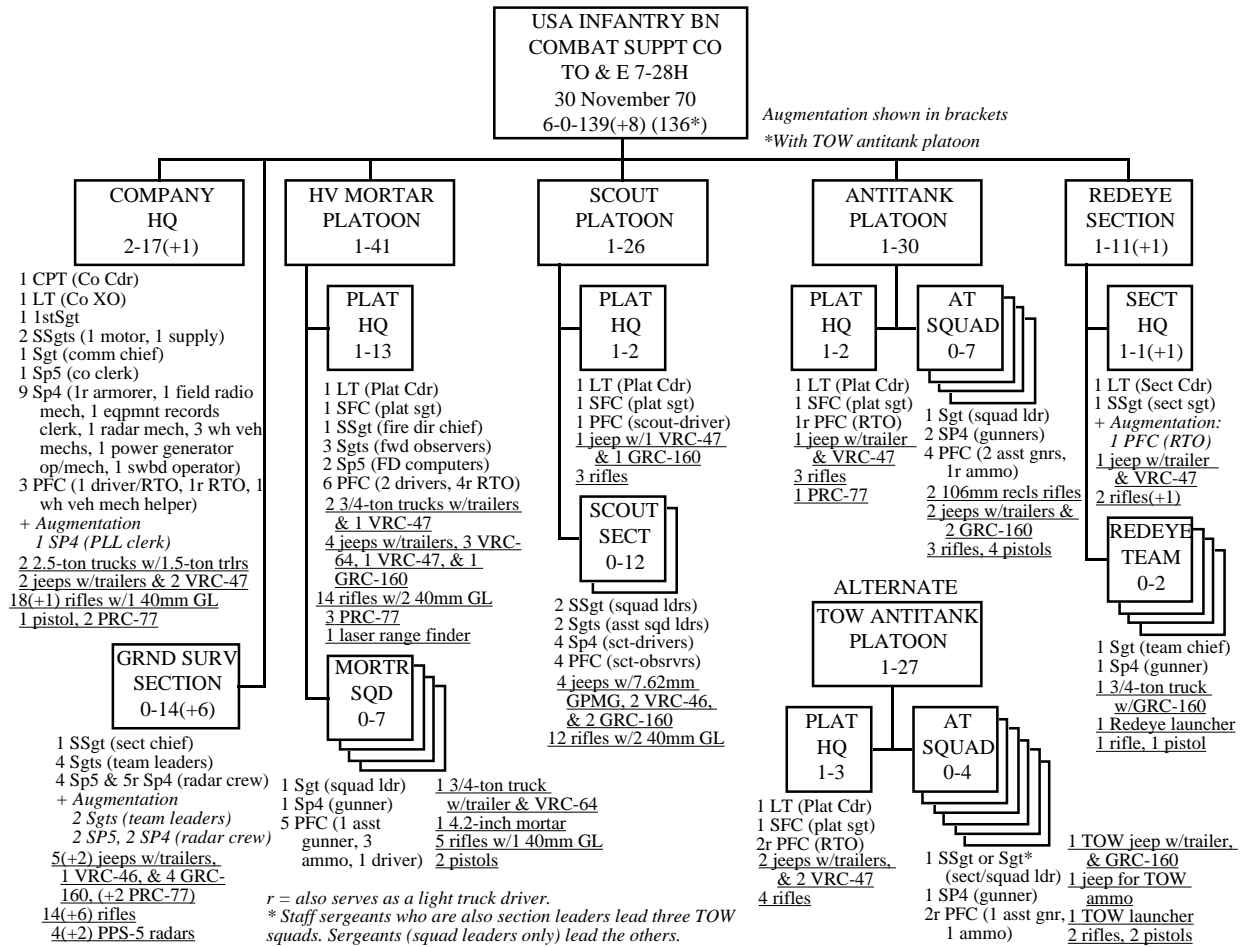

**Small Arms Distribution:** Pistols issued the company commander and all mortar, antitank (TOW or recoilless rifle) and Redeye gunners and assistant gunners. All other personnel carry rifles but the tables do not specify which ones carry M203 40mm grenade launchers on their weapons.

**Notes:**

**Source:** Department of the Army Table of Organization 7-28H "Combat Support Company, Infantry Battalion, Infantry Division or Separate Infantry Brigade" (Washington DC 30 November 1970).



## Appendix 10.5

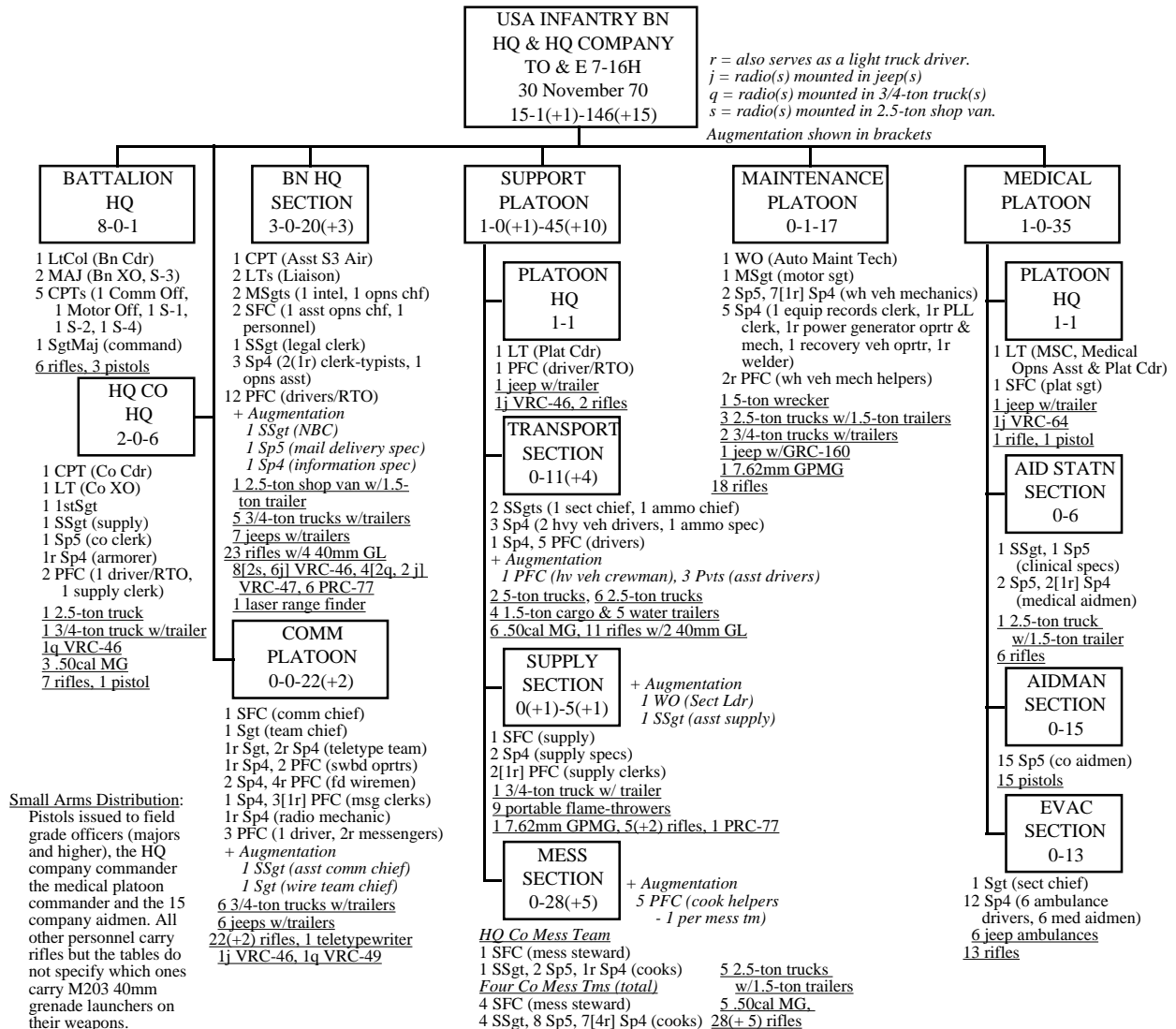

**Small Arms Distribution:**  
 Pistols issued to field grade officers (majors and higher), the HQ company commander the medical platoon commander and the 15 company aidmen. All other personnel carry rifles but the tables do not specify which ones carry M203 40mm grenade launchers on their weapons.

**Notes:**

**Additional Duties:** The Battalion S-1 is also the battalion information officer. The personnel staff NCO (SFC) in the battalion headquarters section is also the battalion information NCO. The support platoon leader is also the assistant S-4. The battalion communication officer also commands the communication platoon. The medical platoon commander is also the battalion medical officer. In the communication platoon one wireman is also an RTO.

**Supply Section:** The warrant officer and staff sergeant in the augmentation element maintain the battalion property book and report on the battalion's equipment status. These personnel are included in any battalion belonging to a division or separate brigade where the new division logistics system (which takes care of this reporting at division level) has not been implemented.

**Mess Section:** The combat support company mess team (one of the four company mess teams) has only one (rather than two) E-4 (Specialist 4) cooks.

**Source:** Department of the Army Table of Organization 7-16H "Headquarters and Headquarters Company, Infantry Battalion, Infantry Division or Separate Infantry Brigade" (Washington DC 30 November 1970).

**Appendix 10.6**

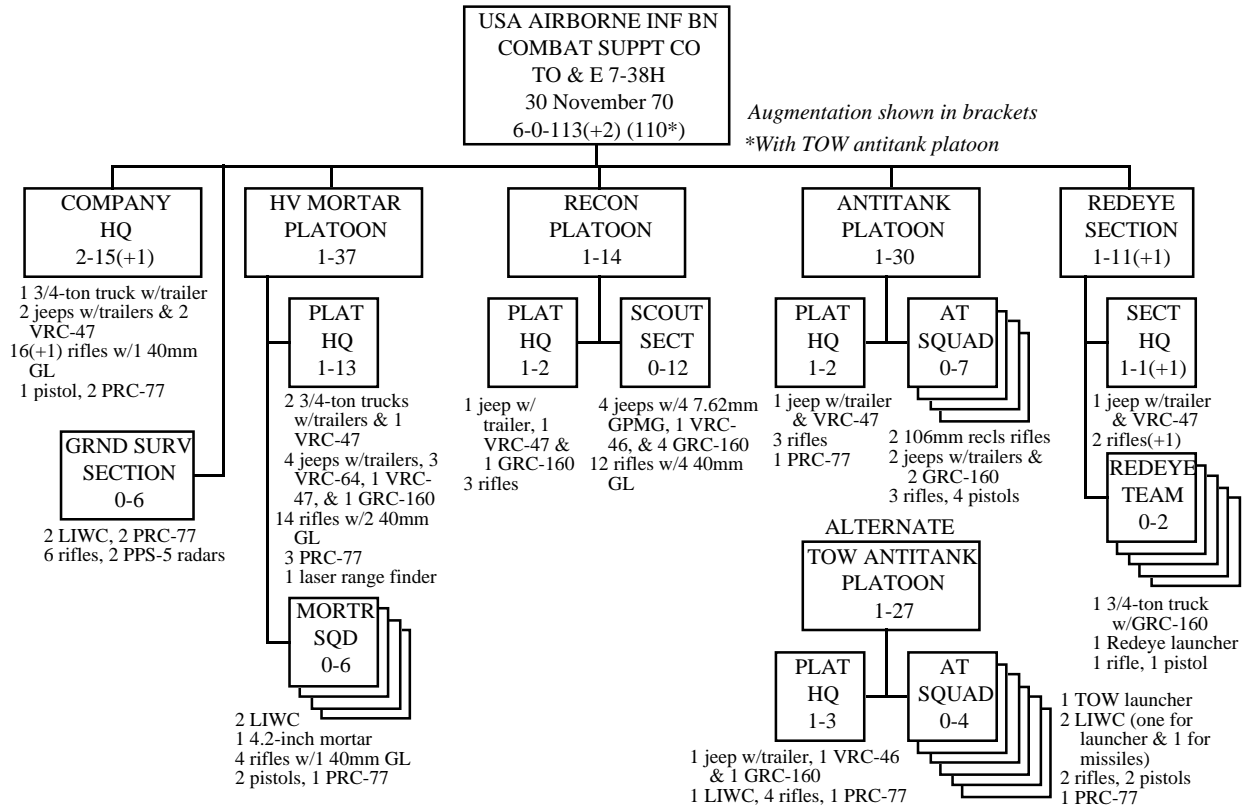
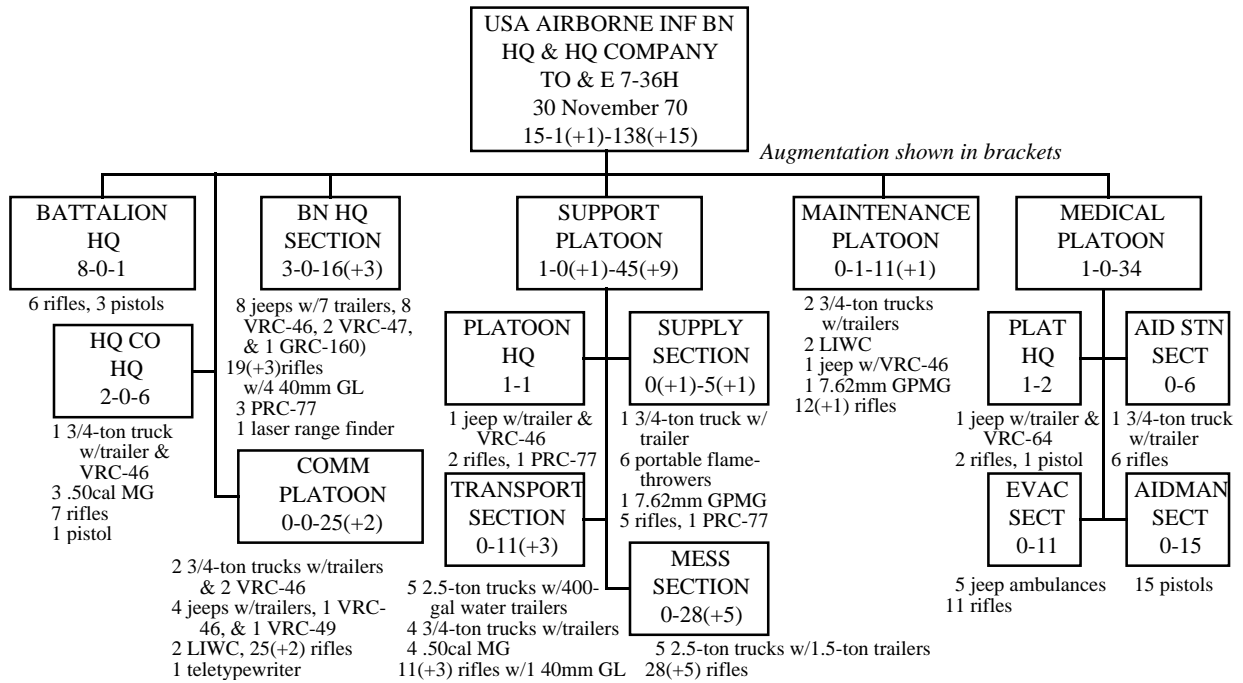

**Notes:**

**Source:** Department of the Army Tables of Organization 7-36H "Headquarters and Headquarters Company, Infantry Battalion (Airborne), Airborne Division or Separate Infantry Brigade" and 7-38H "Combat Support Company, Infantry Battalion (Airborne), Airborne Division or Separate Infantry Brigade" (Washington DC 30 November 1970).

## Appendix 10.7

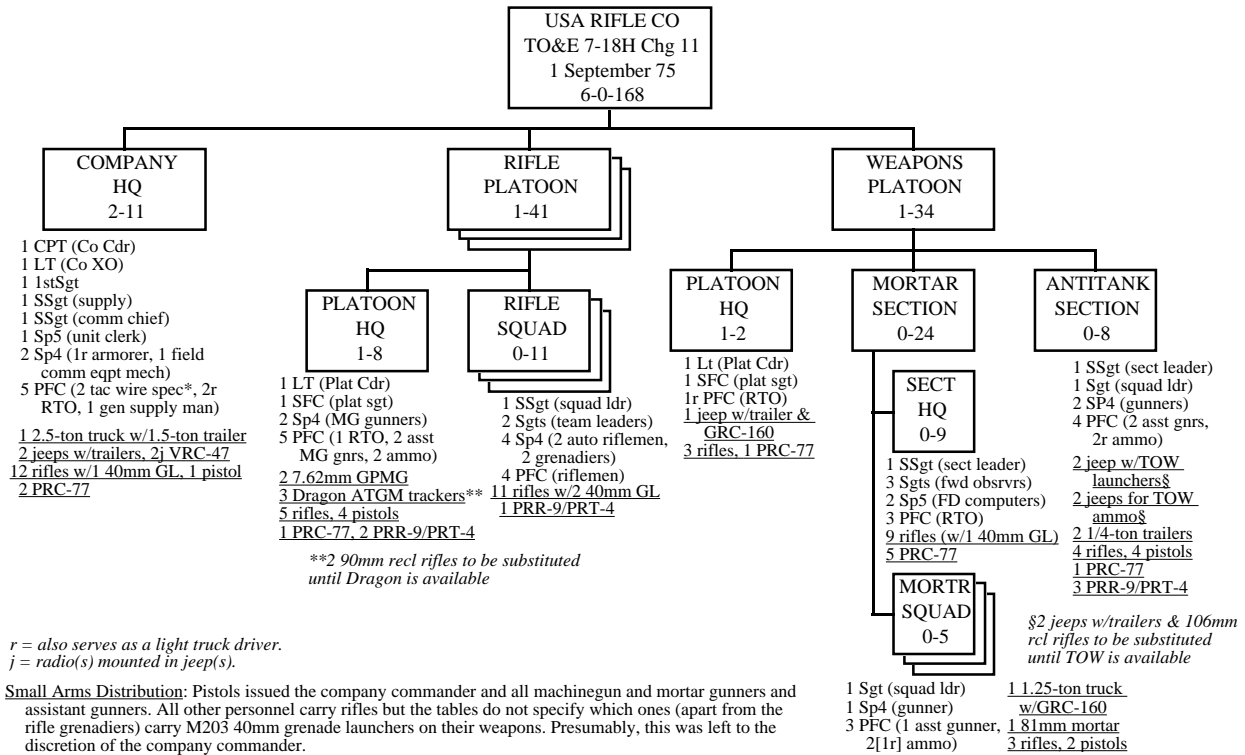

**Notes:**

As in 1970 (see Appendix 10.3) an airborne rifle company (TO&E 7-37H) substituted LIWC vehicles for the mortar section's 3/4-ton, now 1.25-ton trucks, the weapons platoon commander's jeep and the company headquarters' 2.5-ton truck. These differences remained as of Change 10 (dated 1 September 1975) to the airborne company. However, the TOW launchers in the new antitank section would use jeeps, just as they did in an infantry rifle company.

**New Vehicles:** By 1975 the Army had replaced its 3/4-ton trucks (on a not quite one-for-one basis) with the 1.25-ton M561 "Gamma Goat." This vehicle had an articulated suspension system that was supposed to give it superior cross country mobility. It also had a limited ability to swim. However, the additional maintenance that the vehicle required more than cancelled out the advantages of what turned out to be only a very small improvement in cross country performance.

**Source:** Department of the Army Table of Organization 7-15H "Infantry Battalion, Infantry Division or Separate Infantry Brigade" and 7-18H "Rifle Company, Infantry Battalion, Infantry Division or Separate Infantry Brigade" as of Change 11 (1 September 1975) (Washington DC 30 November 1970).

## Appendix 10.8

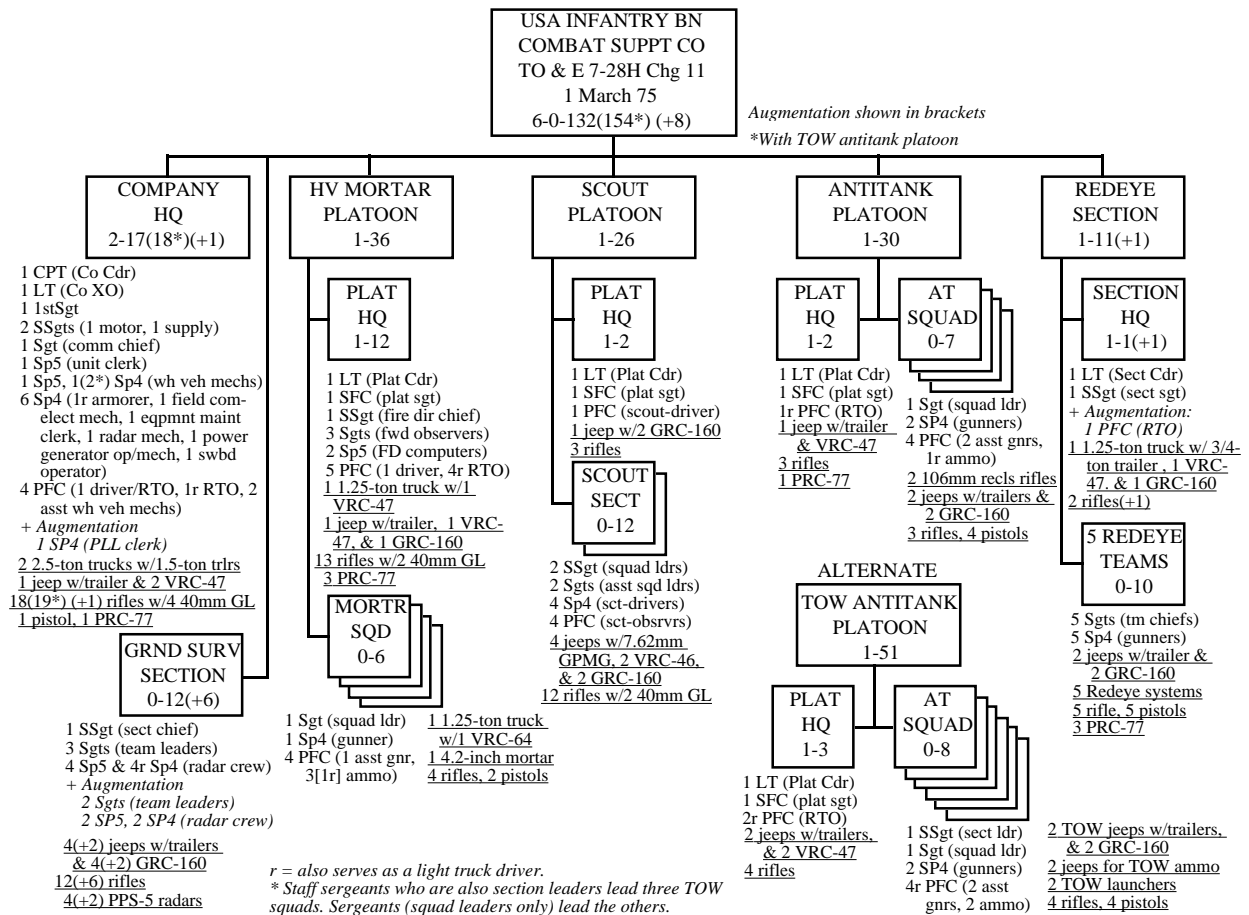

**Small Arms Distribution:** Pistols issued the company commander and all mortar, antitank (TOW or recoilless rifle) and Redeye gunners and assistant gunners. All other personnel carry rifles but the tables do not specify which ones carry M203 40mm grenade launchers on their weapons.

### Notes

For notes on new vehicles see Appendix 10.7.

**Source:** Department of the Army Table of Organization 7-28H "Combat Support Company, Infantry Battalion, Infantry Division or Separate Infantry Brigade" as of Change 11 (1 March 1975) (Washington DC 30 November 1970).

## Appendix 10.9

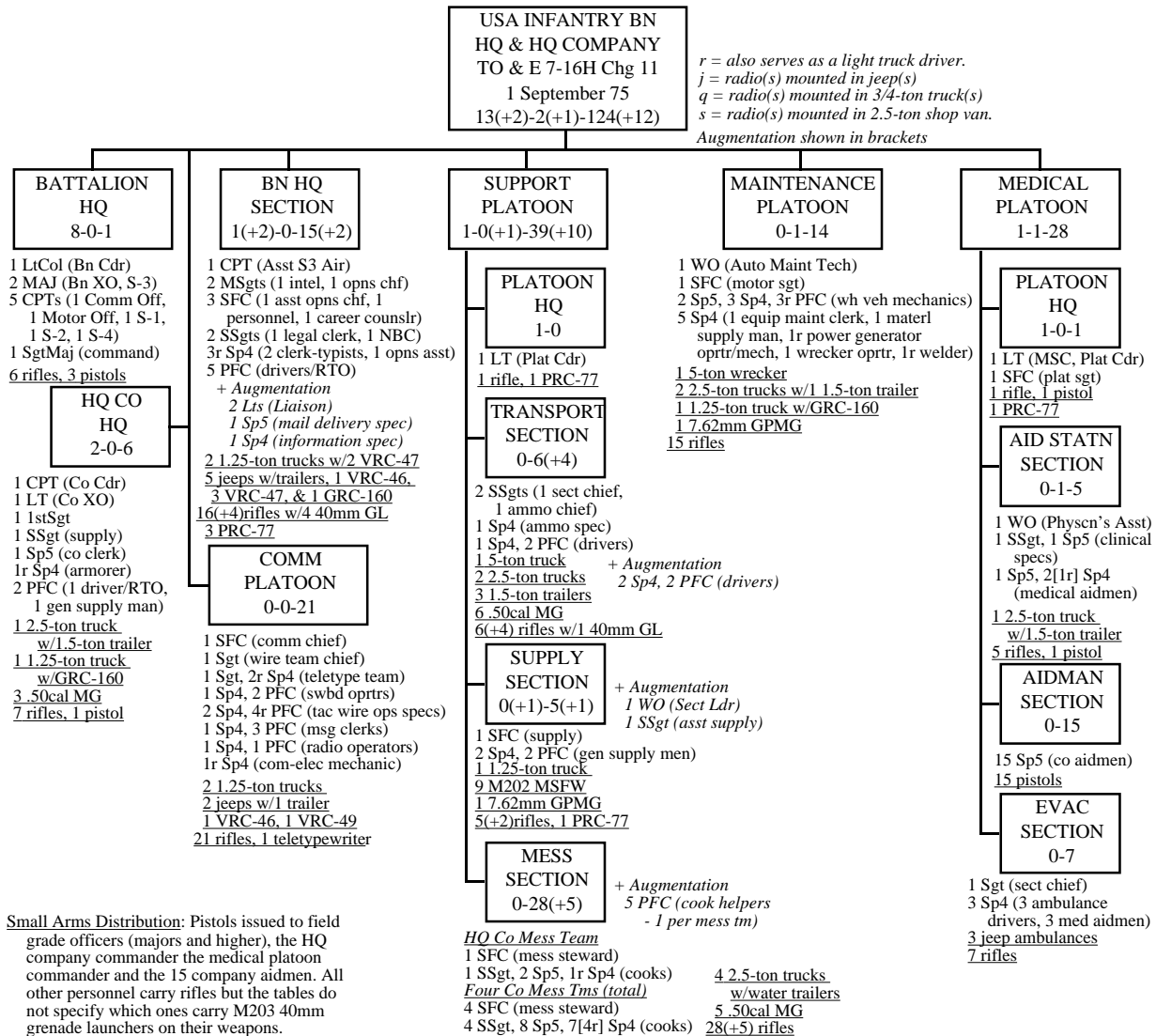

Small Arms Distribution: Pistols issued to field grade officers (majors and higher), the HQ company commander the medical platoon commander and the 15 company aidmen. All other personnel carry rifles but the tables do not specify which ones carry M203 40mm grenade launchers on their weapons.

**Notes:**

For notes on new vehicles see Appendix 10.7.

Source: Department of the Army Table of Organization 7-16H "Headquarters and Headquarters Company, Infantry Battalion, Infantry Division or Separate Infantry Brigade" as of Change 11 (1 September 1975) (Washington DC 30 November 1970).

**Appendix 10.10**

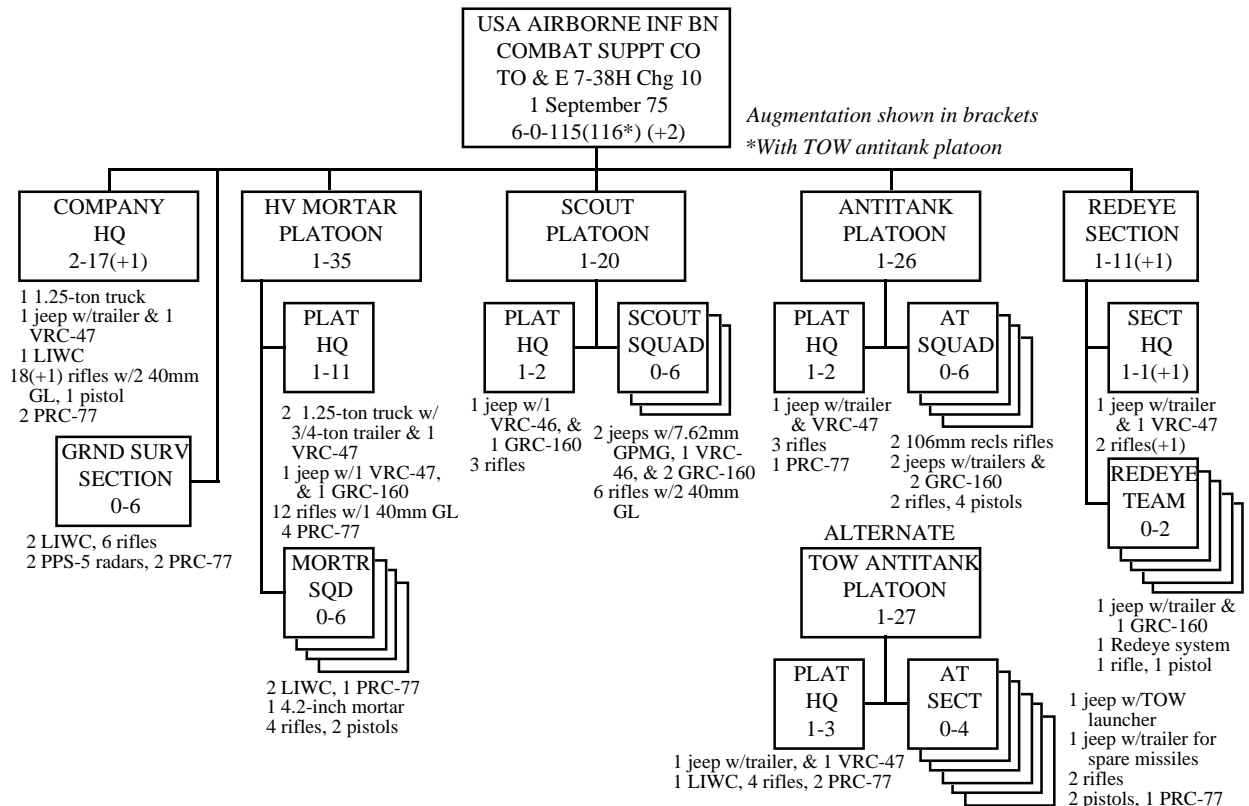
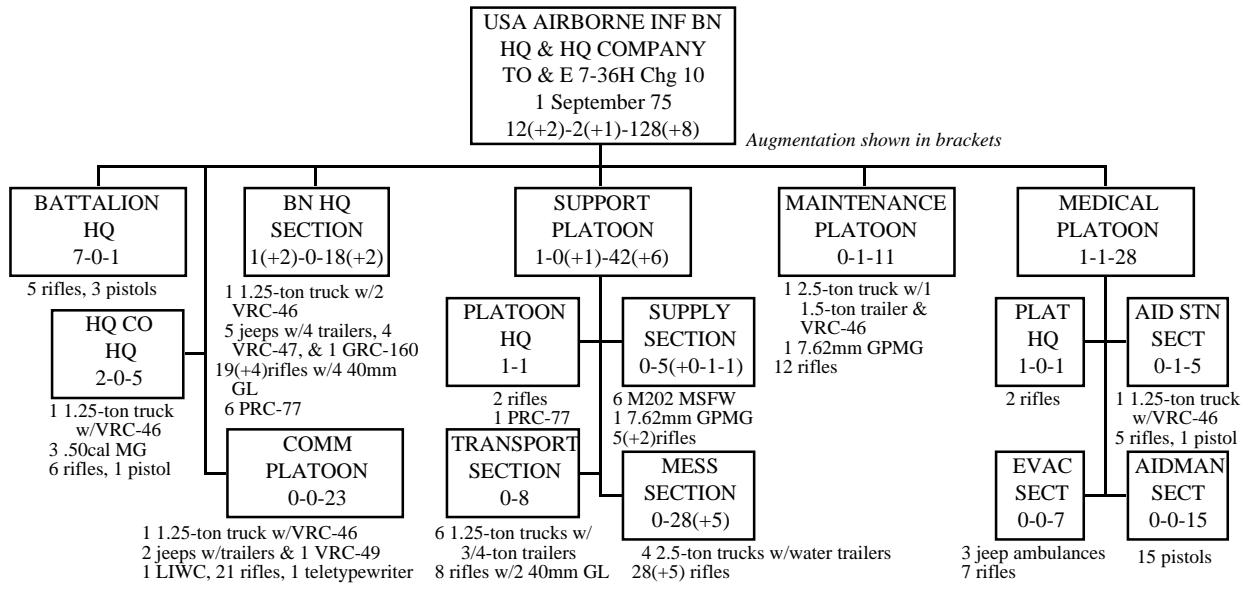

**Notes:**

**Source:** Department of the Army Tables of Organization 7-36H "Headquarters and Headquarters Company, Infantry Battalion (Airborne), Airborne Division or Separate Infantry Brigade" and 7-38H "Combat Support Company, Infantry Battalion (Airborne), Airborne Division or Separate Infantry Brigade" as of Change 10 (1 September 1975) (Washington DC 30 November 1970).

**Appendix 10.11**

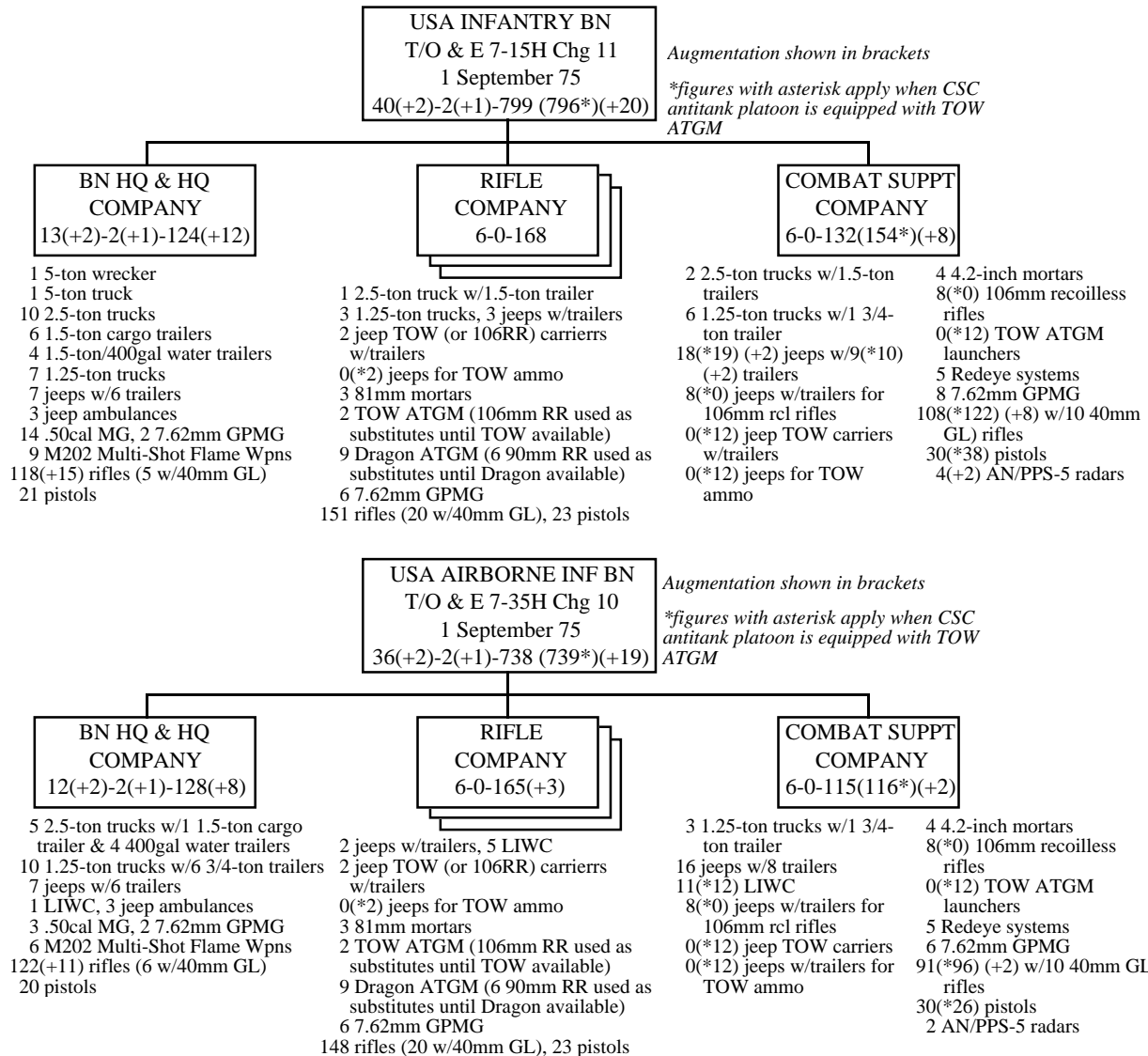

**Notes:**

Source: Department of the Army Table of Organization 7-15H "Infantry Battalion, Infantry Division or Separate Infantry Brigade" as of Change 11 (1 September 1975) and 7-35H "Infantry Battalion (Airborne), Airborne Division or Separate Infantry Brigade" as of Change 10 (1 September 1975) (Washington DC 30 November 1970).

**Appendix 10.12**

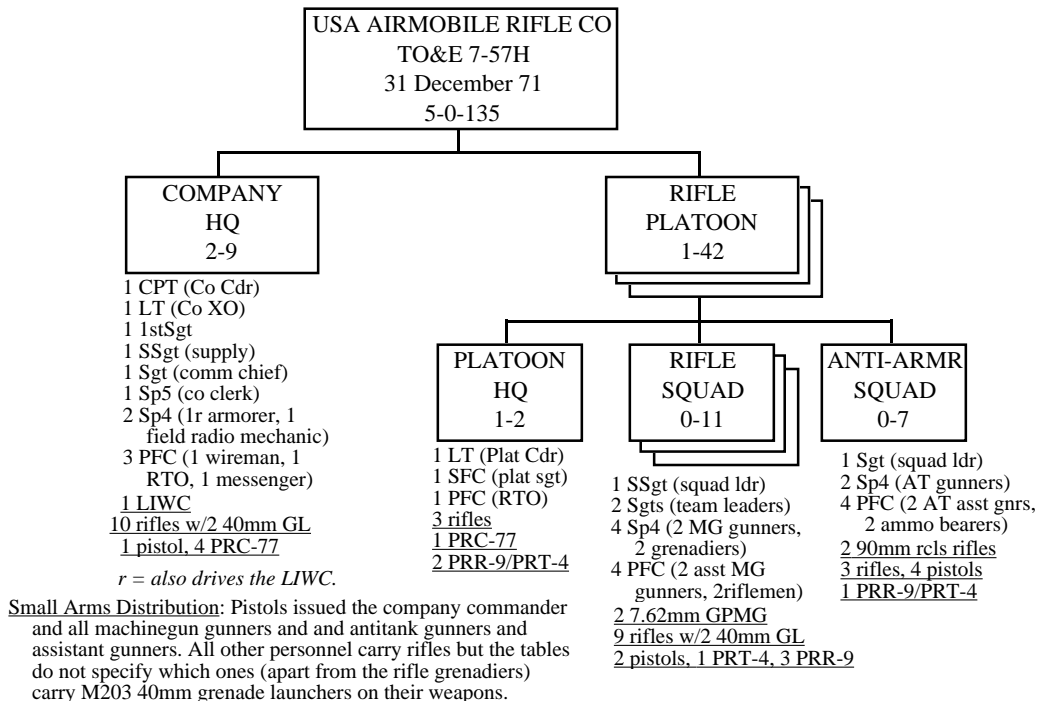
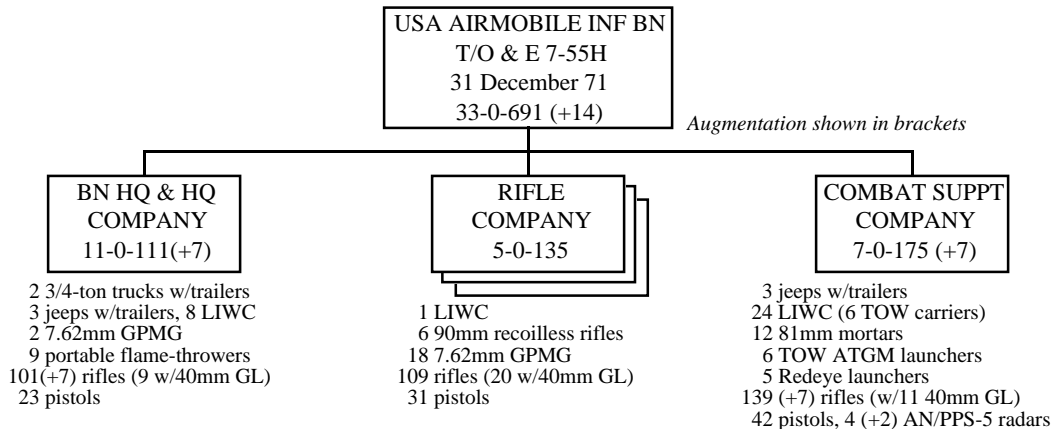

**Notes:**

**TRICAP Tables (TO&E 7-65T) Dated 15 February 1971:** The rifle company above differed from a TRICAP rifle company (TO&E 7-67T) in that the latter in its basic version had no rifle platoon anti-armor squad but instead had an anti-armor team (one SP4, two PFC, one rifle, two pistols, one 90mm recoilless rifle) in each rifle platoon headquarters. The total strength of the company was five officers and 123 men. A version of the company that featured enhanced anti-armor capabilities would have a company-level antitank section (with a staff sergeant, a PFC driver, one LIWC, two rifles and three anti-armor squads. Each squad would have a sergeant, an Sp4 (gunner), two PFC, two rifles, two pistols, a TOW missile system and an LIWC. Instead of a platoon headquarters antiarmor team each rifle platoon would have an antiarmor squad of three teams. Each team was the same as the one team under the basic organization except that the senior team leader (and gunner) was a sergeant who was also the squad leader. This enhanced company had a total of five officers and 155 men.

**Sources:** Department of the Army Table of Organization 7-55H "Infantry Battalion, Air-Mobile Division" and 7-57H "Rifle company, Infantry Battalion, Air-Mobile Division" (Washington DC 31 December 1971).



Appendix 10.13

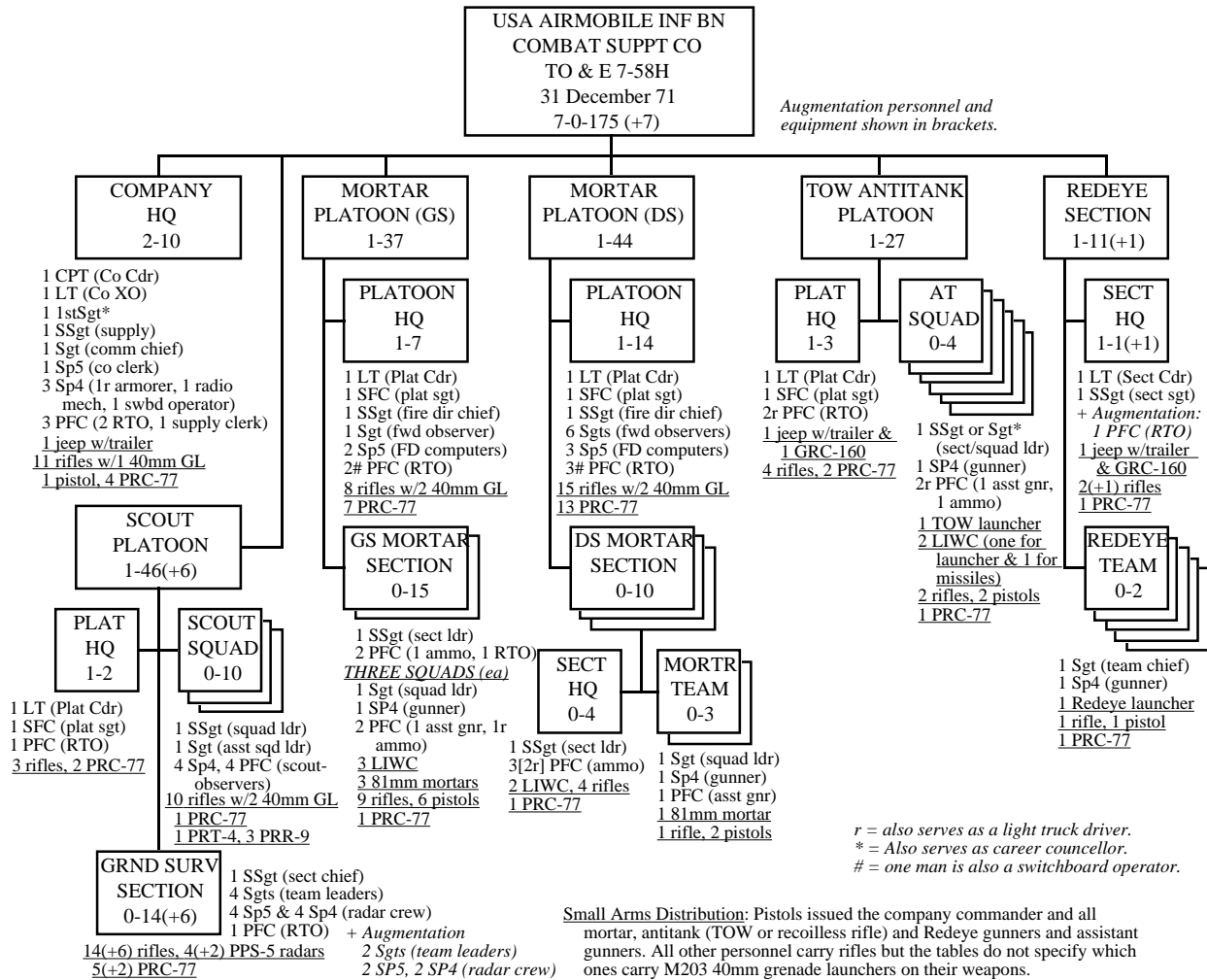

Notes:

TRICAP Tables (TO&E 7-65T) Dated 15 February 1971: There were only minor differences between this company and its TRICAP counterpart (TO&E 7-68T). These differences were as follows: (1) the ground surveillance section had a radar mechanic; (2) no switchboard operator or radio mechanic in company headquarters; (3) could have a recoilless rifle antitank platoon (of one officer, 30 men and eight 106mm rifles or the same as in an infantry battalion CSC) in lieu of a TOW platoon or it might have two TOW platoons. Total strength could be either seven officers and 177 enlisted (with recoilless rifle platoon), seven officers and 174 enlisted (with one TOW platoon) or eight officers and 201 enlisted (two TOW platoons).

Source: Department of the Army Table of Organization 7-58H "Combat Support Company, Infantry Battalion, Air-Mobile Division" (Washington DC 31 December 1971).

## Appendix 10.14

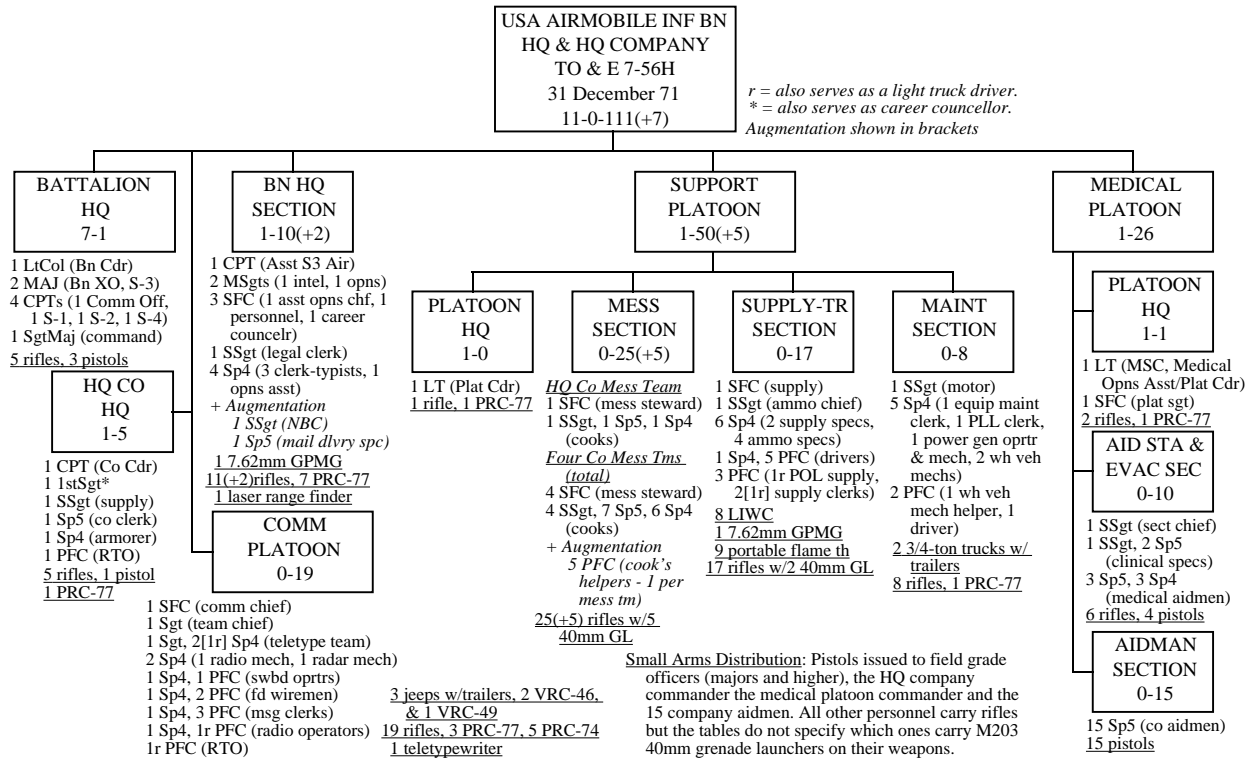

**Notes:**

TRICAP Tables (TO&E 7-65T) Dated 15 February 1971): The differences between this company and its TRICAP counterpart (TO&E 7-66T) were also minor. They were as follows: (1) communication platoon had no radar mechanic but has two radio mechanics (one Sp5 and one Sp4) rather than one, only one PFC wireman, six radio operators (three Sp4 and three PFC) rather than two and a motor messenger in lieu of an RTO; (2) no augmentation for the battalion headquarters section; (3) supply and transport section includes a warrant officer (not an augmentation) but has only three ammunition specialists (rather than four) and only one supply clerk (rather than two); (4) the maintenance section had two drivers (PFC) rather than one; (4) the mess section had larger mess team (an SFC, 1 SSgt, 2 Sp5, 1 Sp4 and one PFC for the headquarters company; the same for each rifle company except for only one Sp5 and two Sp4; and the same for the combat support company except for two Sp5 and two Sp4); and (5) there was an RTO in the medical platoon headquarters. The total strength of the TRICAP company was 11 officers, a warrant officer and 119 men.

Source: Department of the Army Table of Organization 7-56H "Headquarters and Headquarters Company, Infantry Battalion, Air-Mobile Division" (Washington DC 31 December 1971).

**Appendix 10.15**

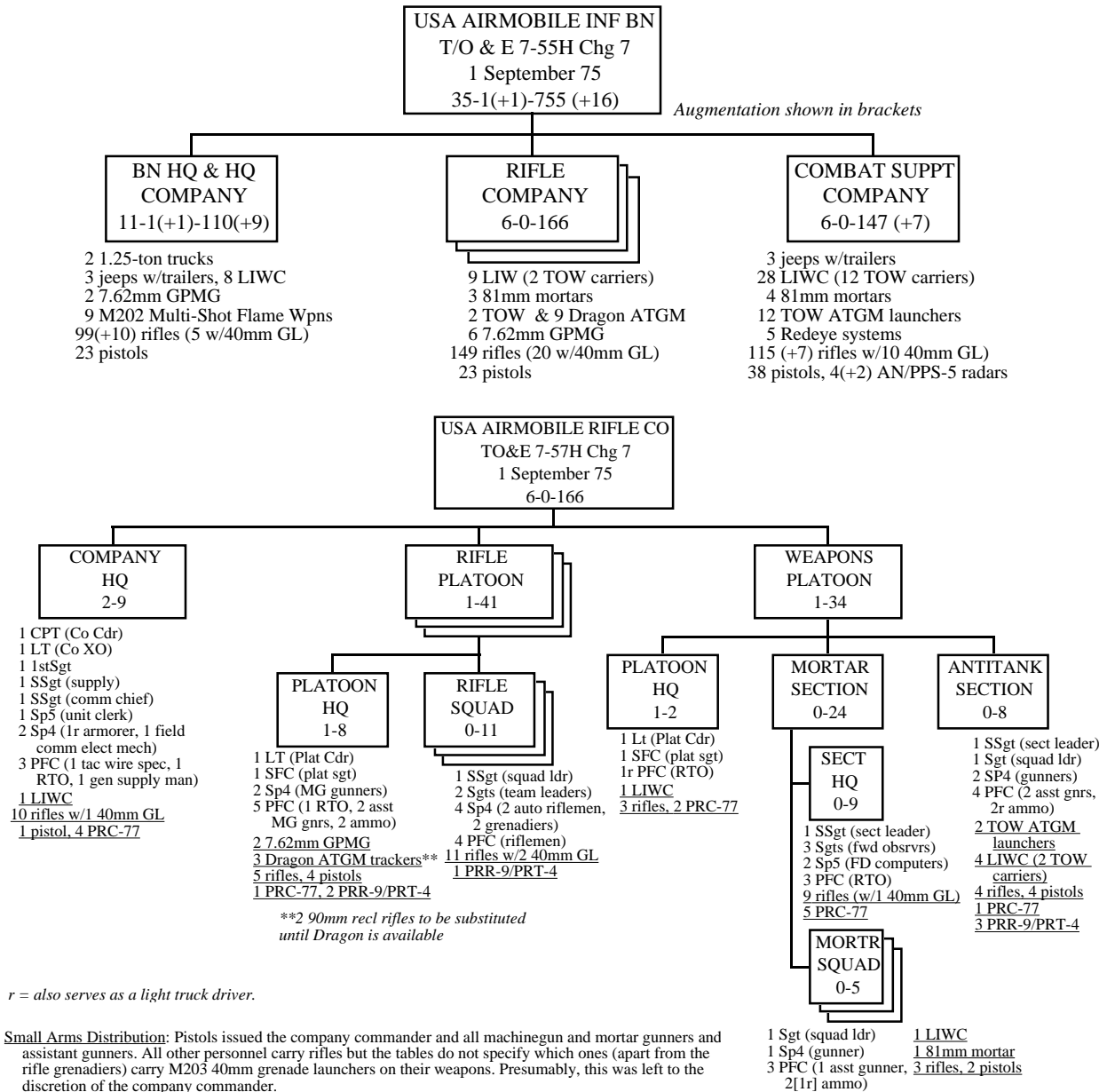

**Notes:**

**Sources:** Department of the Army Table of Organization 7-55H "Infantry Battalion, Air-Mobile Division" and 7-57H "Rifle company, Infantry Battalion, Air-Mobile Division" to Change 7 (1 September 1975) (Washington DC 31 December 1971).

## Appendix 10.16

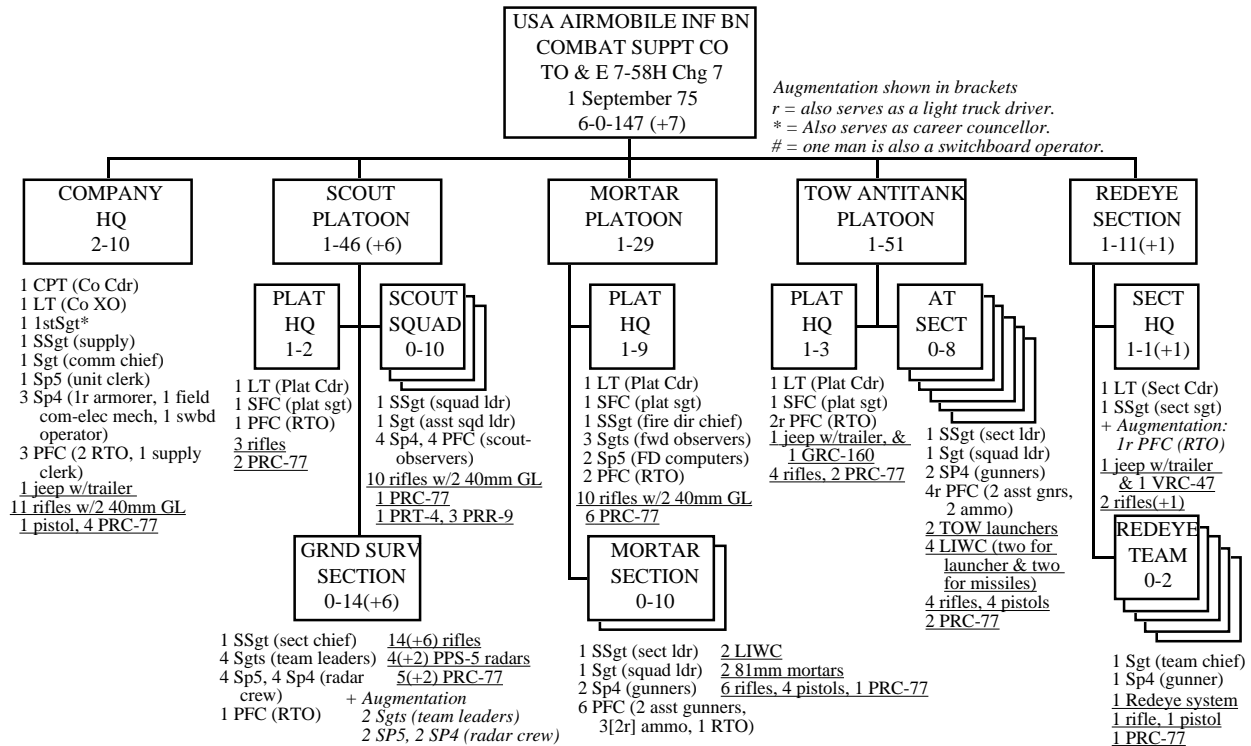

**Small Arms Distribution:** Pistols issued the company commander and all mortar, antitank (TOW or recoilless rifle) and Redeye gunners and assistant gunners. All other personnel carry rifles but the tables do not specify which ones carry M203 40mm grenade launchers on their weapons.

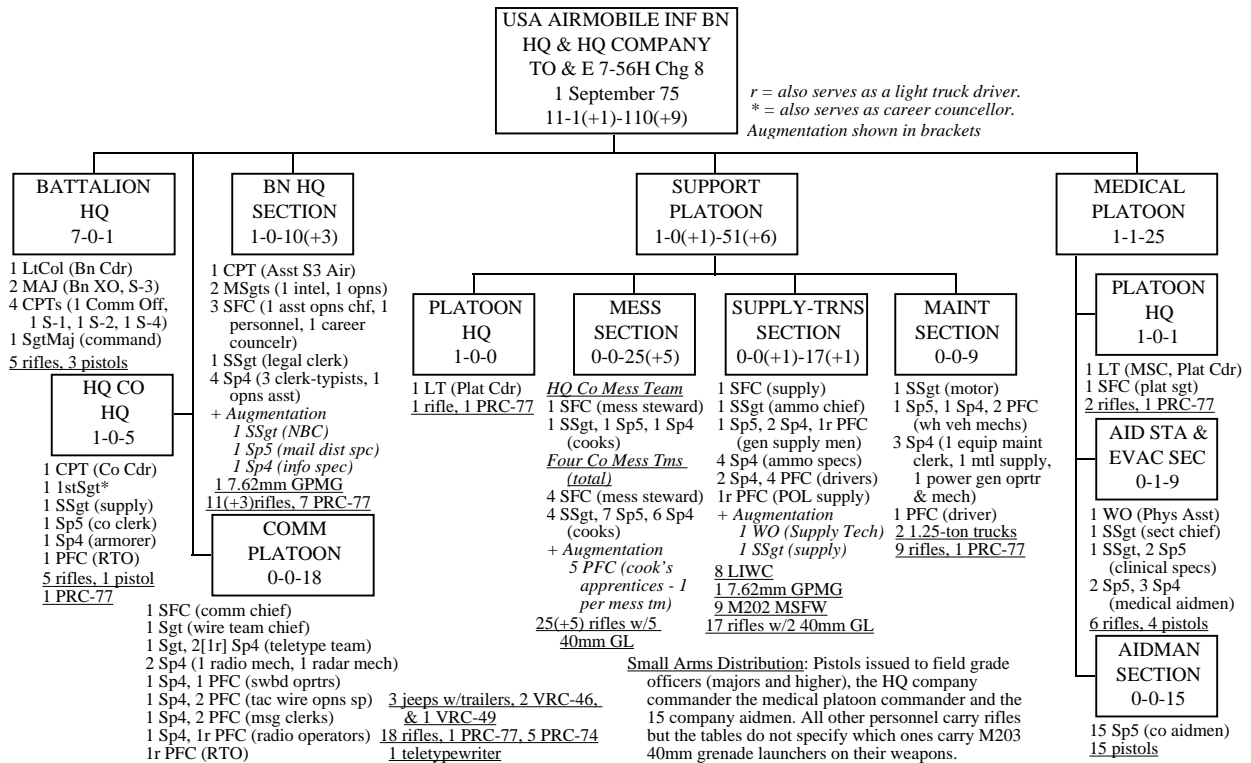

Notes:

**Source:** Department of the Army Table of Organization 7-58H "Combat Support Company, Infantry Battalion, Air-Mobile Division" to Change 7 (1 September 1975) and 7-56H "Headquarters and Headquarters Company, Infantry Battalion, Air-Mobile Division" to Change 8 (1 September 1975) (Washington DC 31 December 1971).

Appendix 10.17

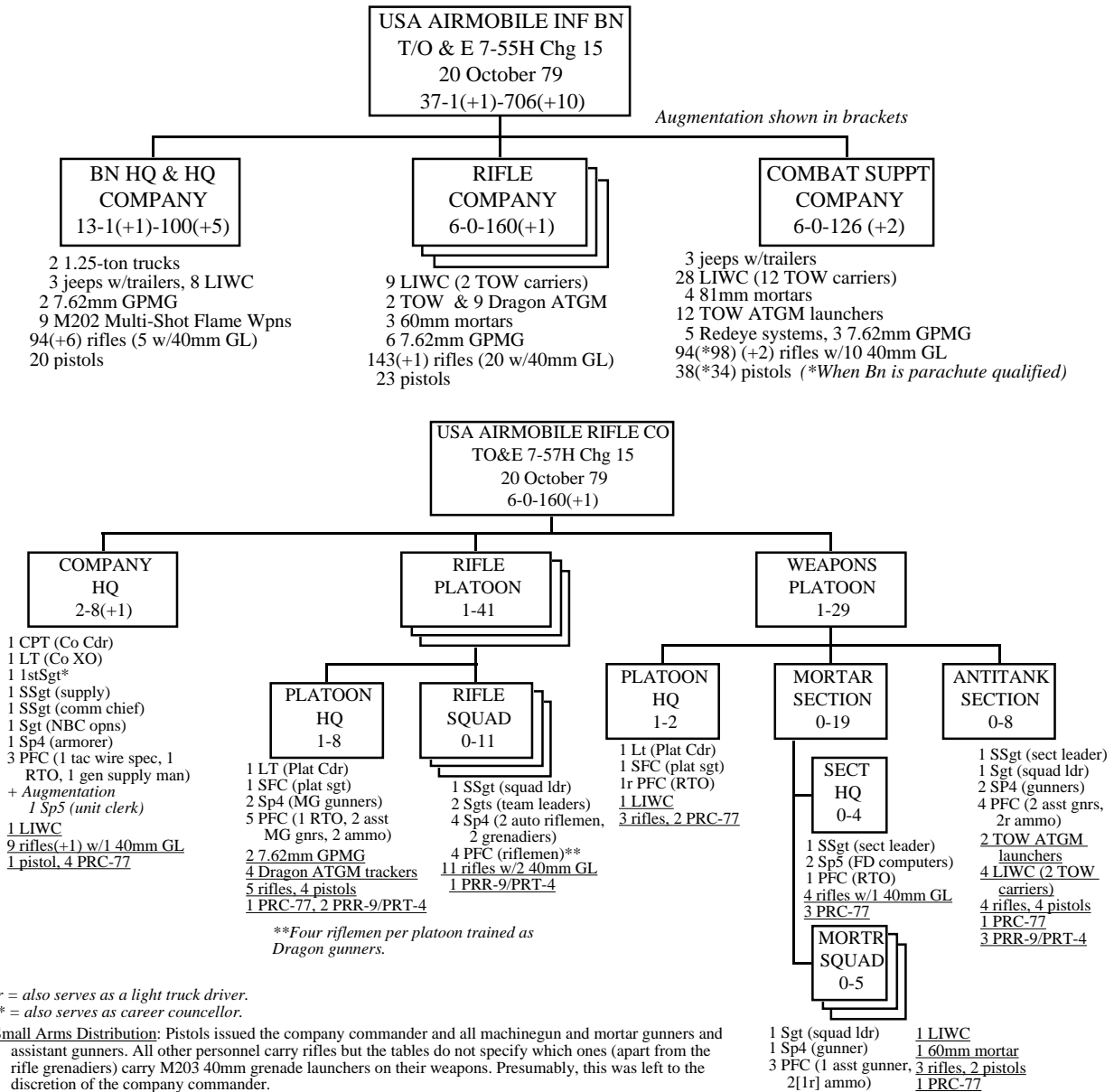

Notes:

The 60mm mortars were planned but not available at this time. Therefore 81mm mortars would have remained in use.

Sources: Department of the Army Table of Organization 7-55H "Infantry Battalion, Air-Mobile Division" and 7-57H "Rifle company, Infantry Battalion, Air-Mobile Division" to Change 15 (20 October 1979) (Washington DC 31 December 1971).

**Appendix 10.18**

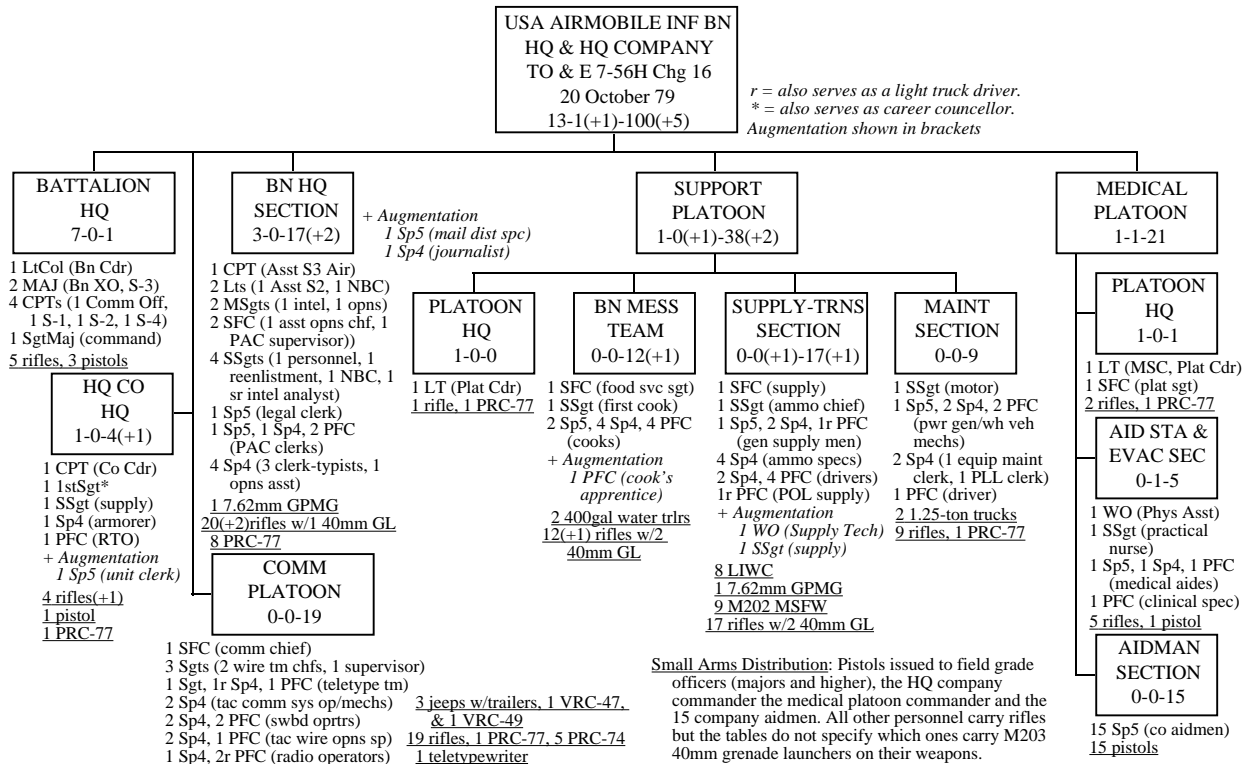
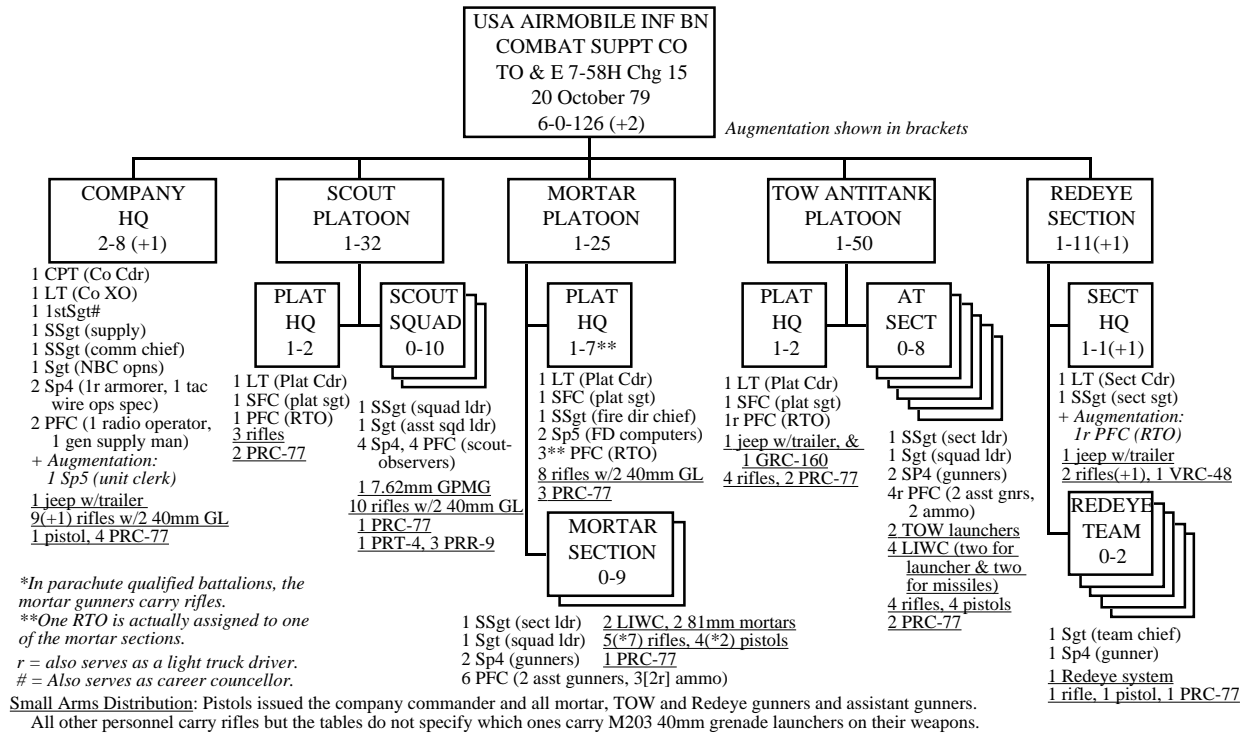

Notes:

Source: Department of the Army Table of Organization 7-58H "Combat Support Company, Infantry Battalion, Air-Mobile Division" to Change 15 (20 October 1979) and 7-56H "Headquarters and Headquarters Company, Infantry Battalion, Air-Mobile Division" to Change 16 (20 October 1979) (Washington DC 31 December 1971).

Appendix 10.19

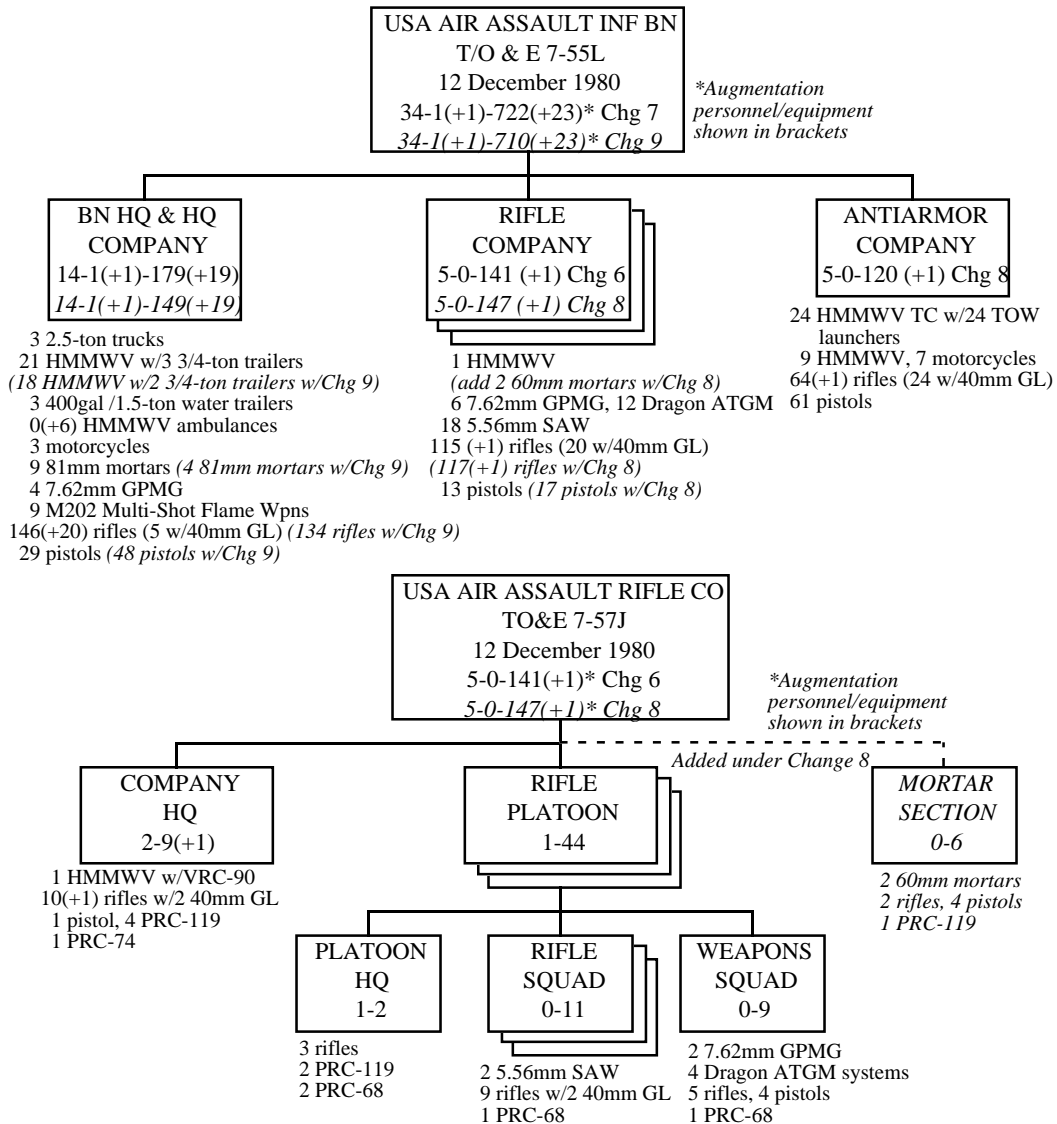

Notes:

These tables appear to have been experimental and probably did not see more than limited use prior to 1985 when the Army of Excellence (AOE) series of tables superceded them. Much of the equipment shown, especially the radios, 60mm mortars and HMMWV trucks was not yet available. Older types would have remained in use. A jeep and trainer with an AN/VRC-46 or 47 or an LIWC would have served in lieu of the HMMWV and AN/VRC-90. AN/PRC-77 man-pack radios would have served in place of the AN/PRC-119. Each rifle squad would have had two additional rifles rather than the still unavailable M249 squad automatic weapons (SAW). No 60mm mortar section was even theoretically available prior to 1984.

Source: Department of the Army Table of Organization 7-55J "Infantry Battalion, Air-Assault Division" and 7-57J "Rifle company, Infantry Battalion, Air-Mobile Division" to Change 8 (April 1984) (Washington DC 12 December 1980).

Appendix 10.20

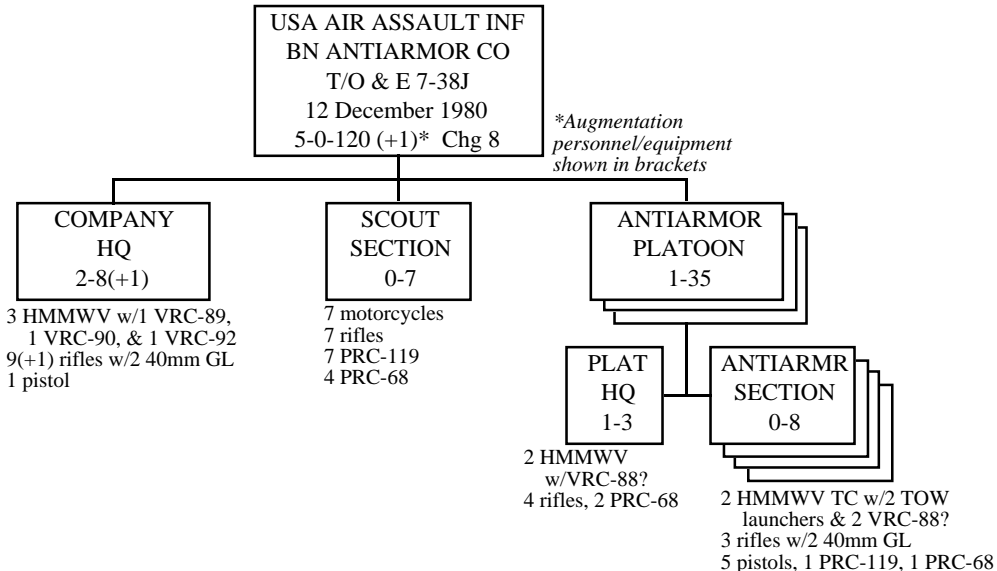
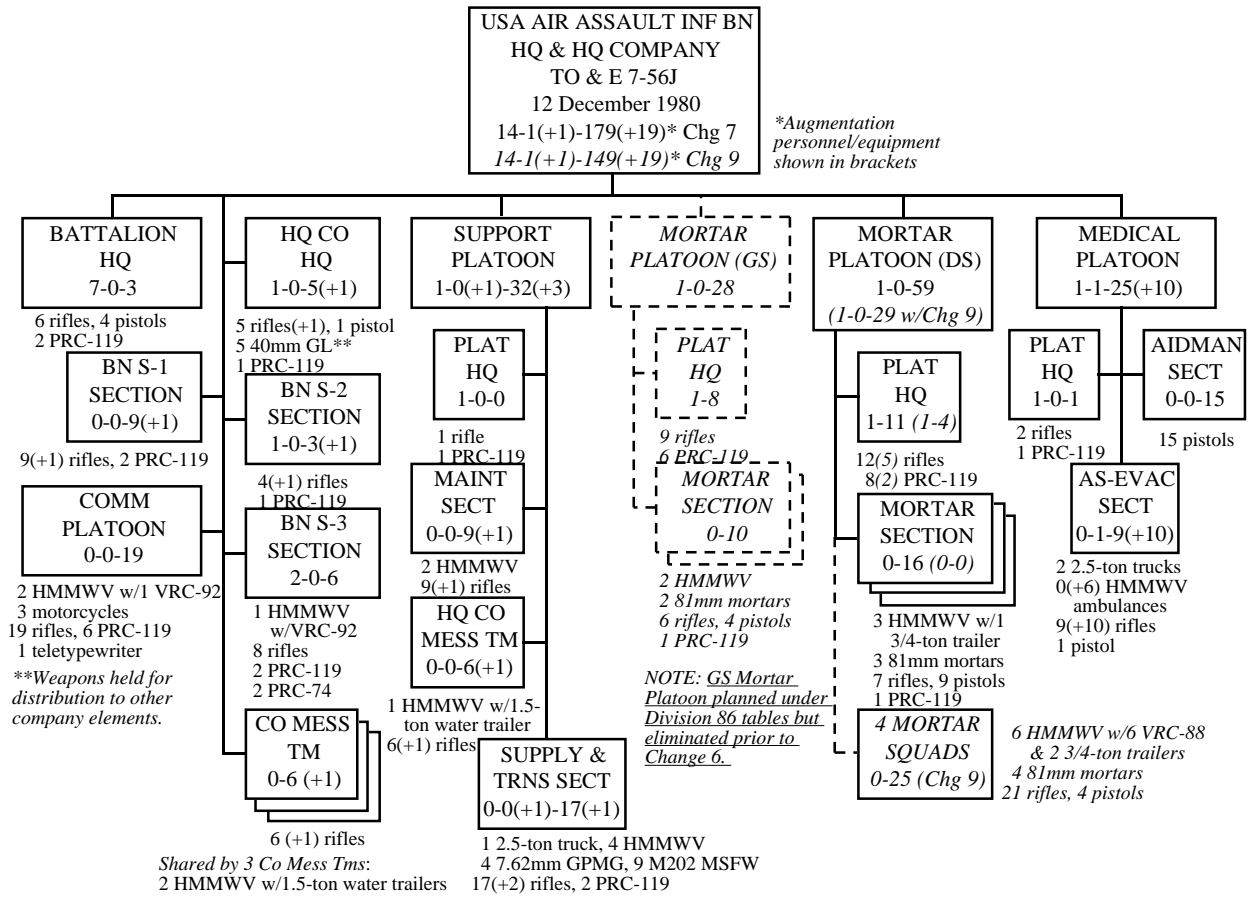

Notes:

See the notes for Appendix 10.19 above. Two jeeps (one for the launcher and one for spare missiles) would have served in lieu of each HMMWV Tow Carrier (TC). Single jeeps with trailers would replace the other HMMWV.

Source: Department of the Army Table of Organization 7-58J "Anti-armor Company, Infantry Battalion, Air-Assault Division" to Change 8 (April 1984) and 7-56J "Headquarters and Headquarters Company, Infantry Battalion, Air-Assault Division" to Change 8 (April 1984) (Washington DC 12 December 1980).



## Appendix 10.21

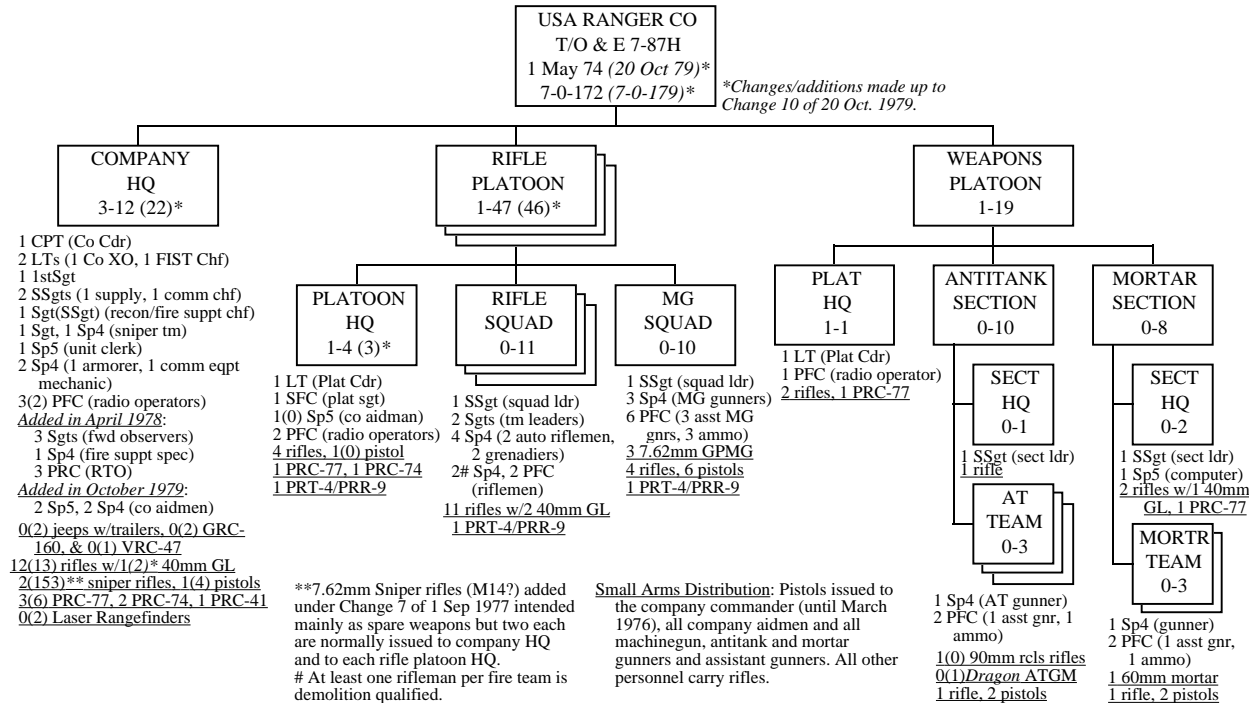
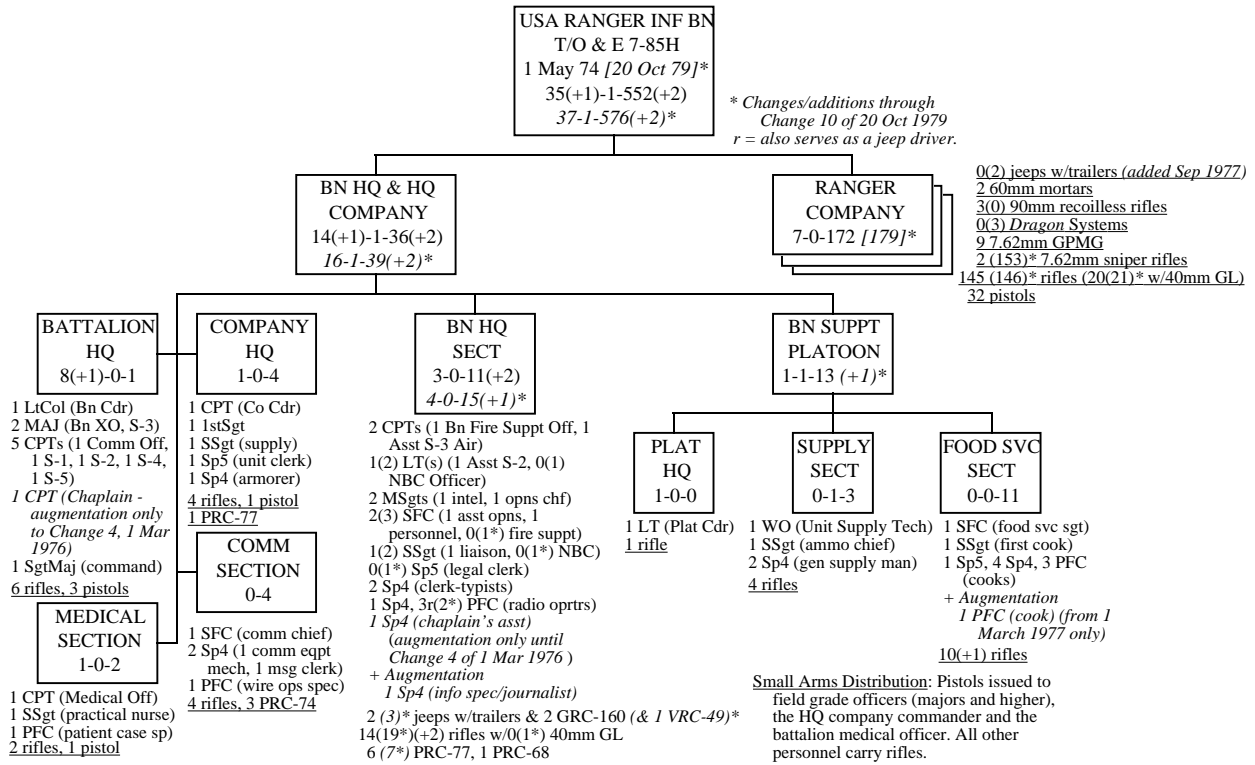

**Notes:**

**Source:** Department of the Army Tables of Organization 7-85H "Ranger Infantry Battalion;" 7-86H "Headquarters and Headquarters Company, Ranger Battalion" and 7-87H "Rifle Company, Ranger Battalion" (with changes up to Change 10 of 20 Dec 1979) (Washington DC 1 May 1974).

Appendix 10.22

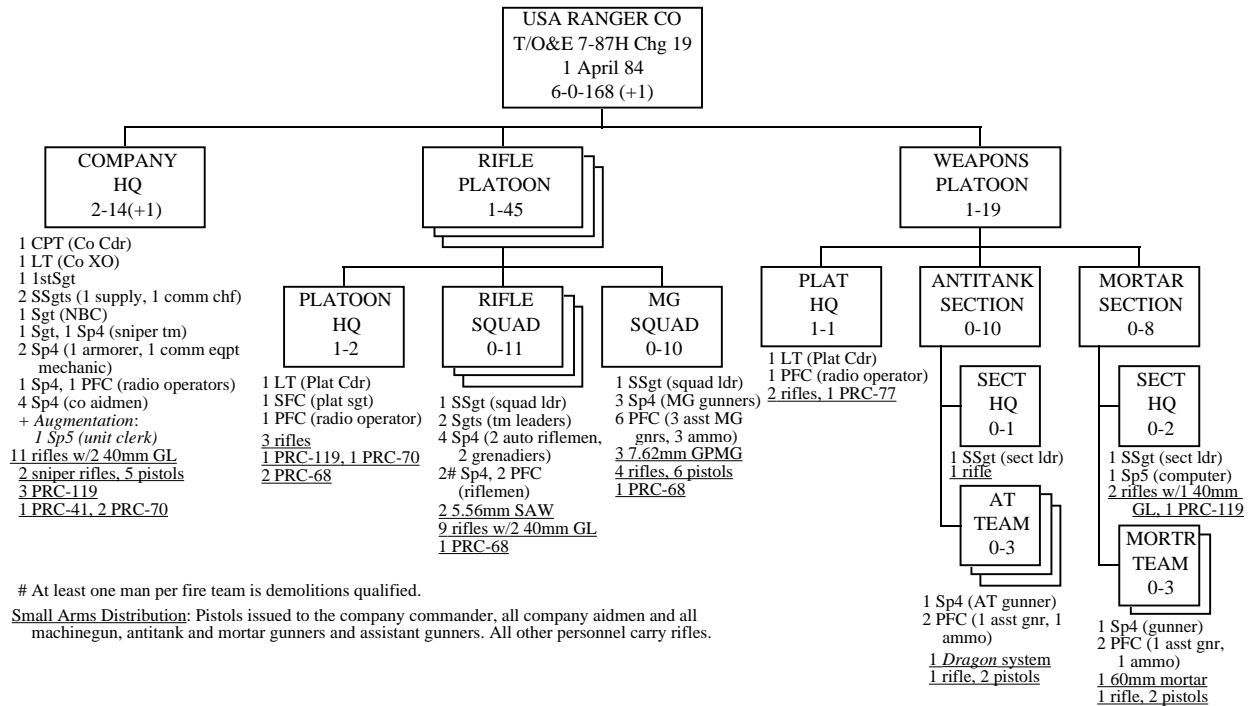
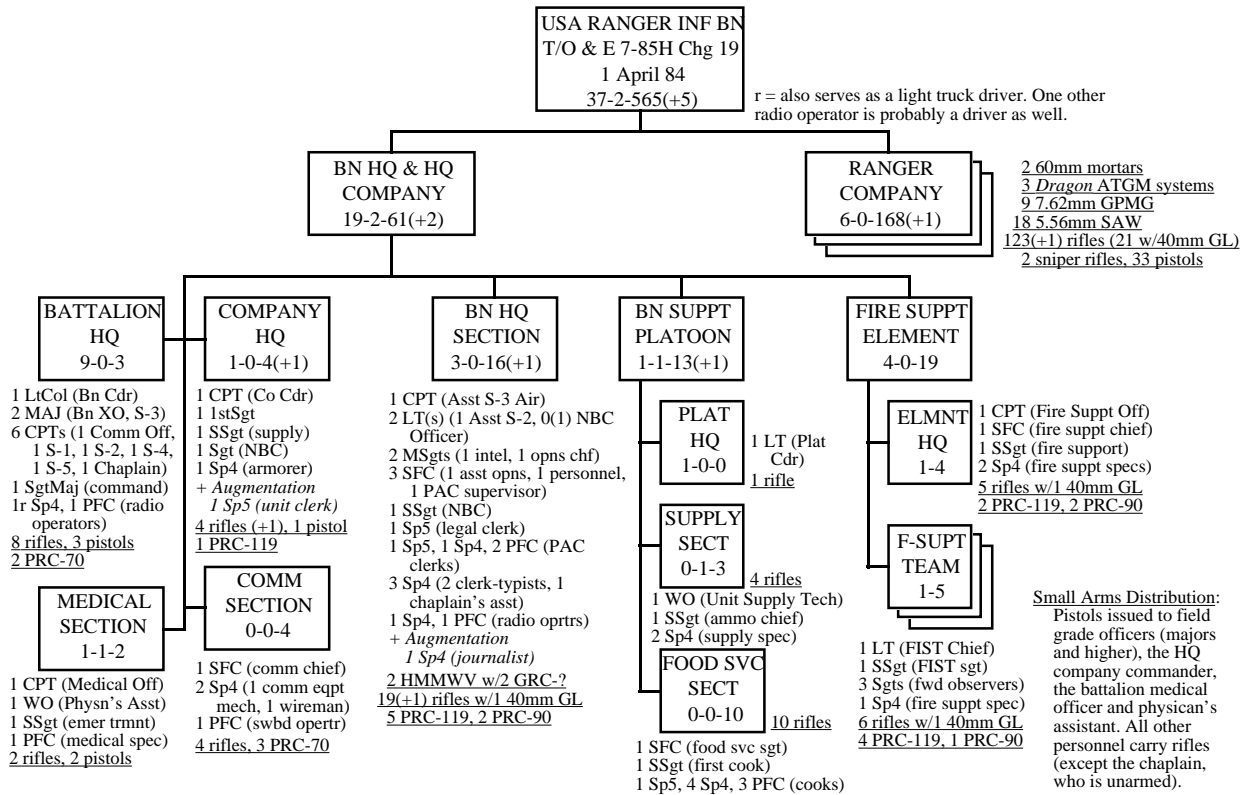

Notes:

Source: Department of the Army Tables of Organization 7-85H "Ranger Infantry Battalion;" 7-86H "Headquarters and Headquarters Company, Ranger Battalion" and 7-87H "Rifle Company, Ranger Battalion" (with changes up to Change 19 of 1 April 1984) (Washington DC 1 May 1974).

Appendix 10.23

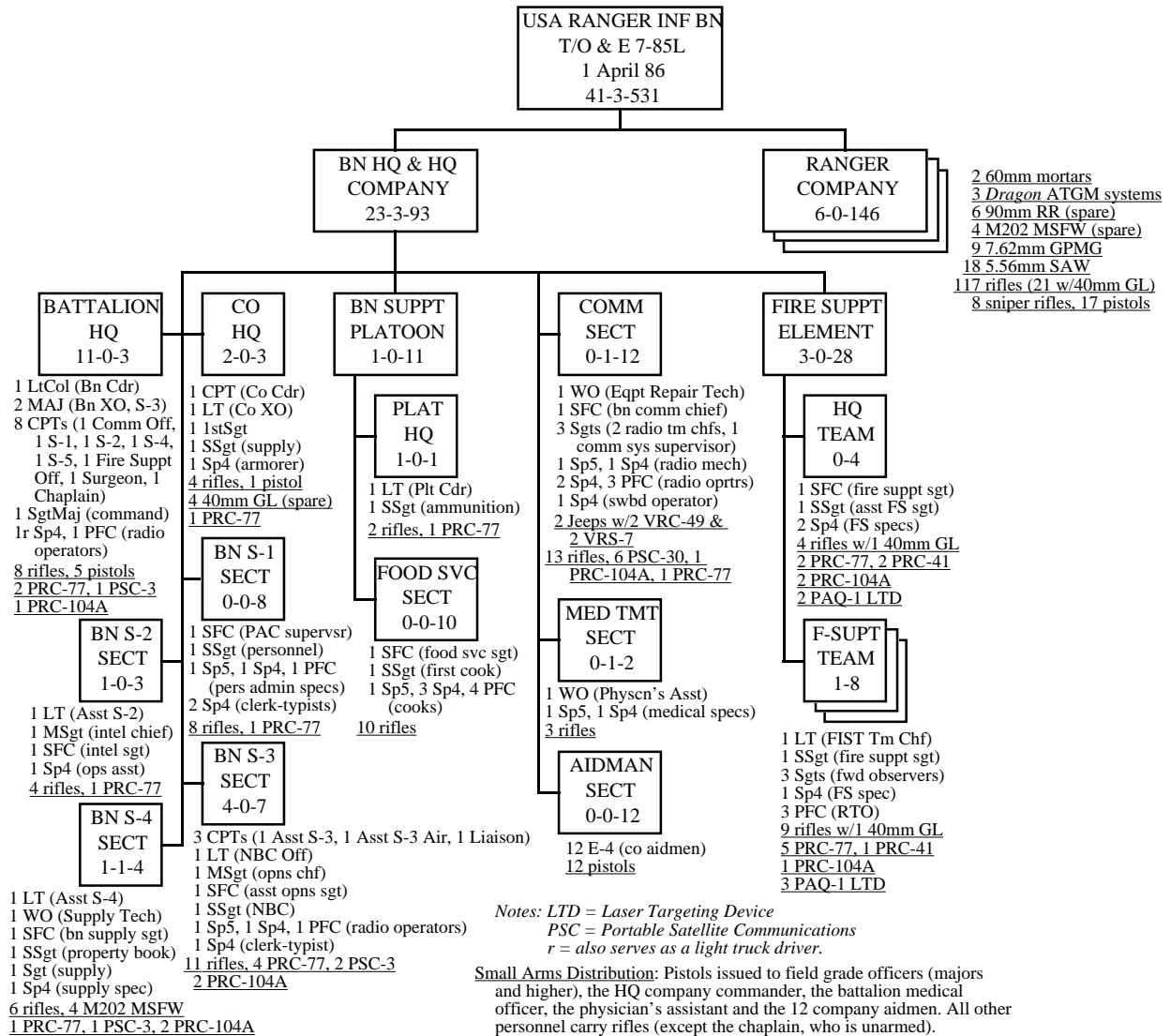

**Appendix 10.23 (Continued)**

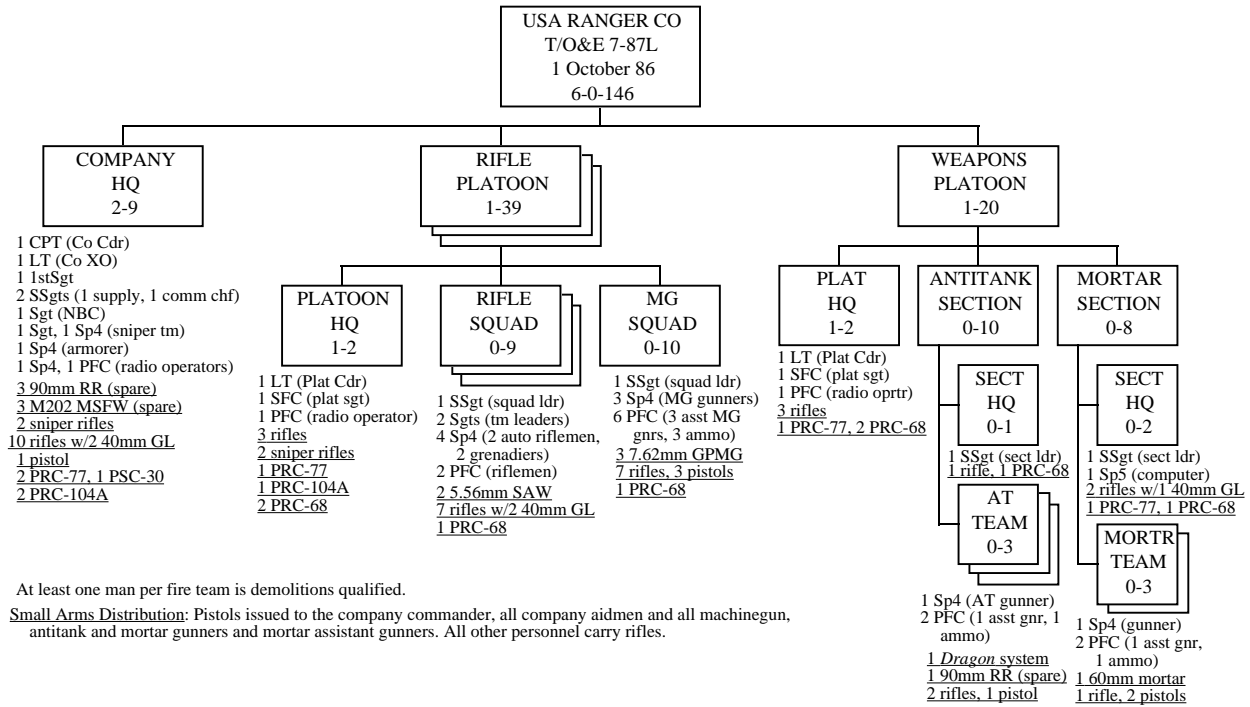

**Notes:**

Source: Department of the Army Tables of Organization 7-85L "Ranger Infantry Battalion;" 7-86L "Headquarters and Headquarters Company, Ranger Battalion" and 7-87L "Rifle Company, Ranger Battalion" (Washington DC 1 October 1986).

Appendix 10.24

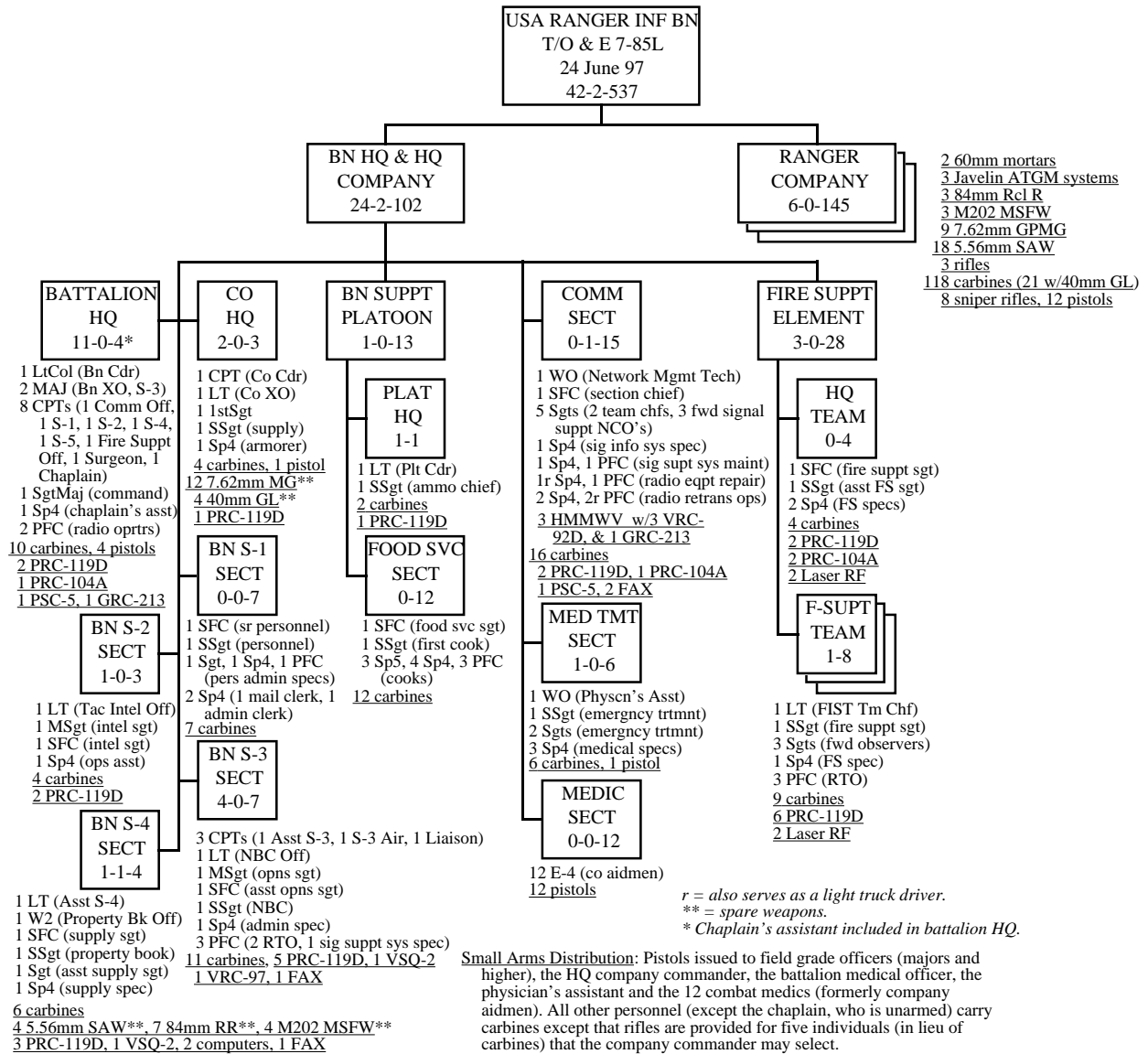

**Appendix 10.24 (continued)**

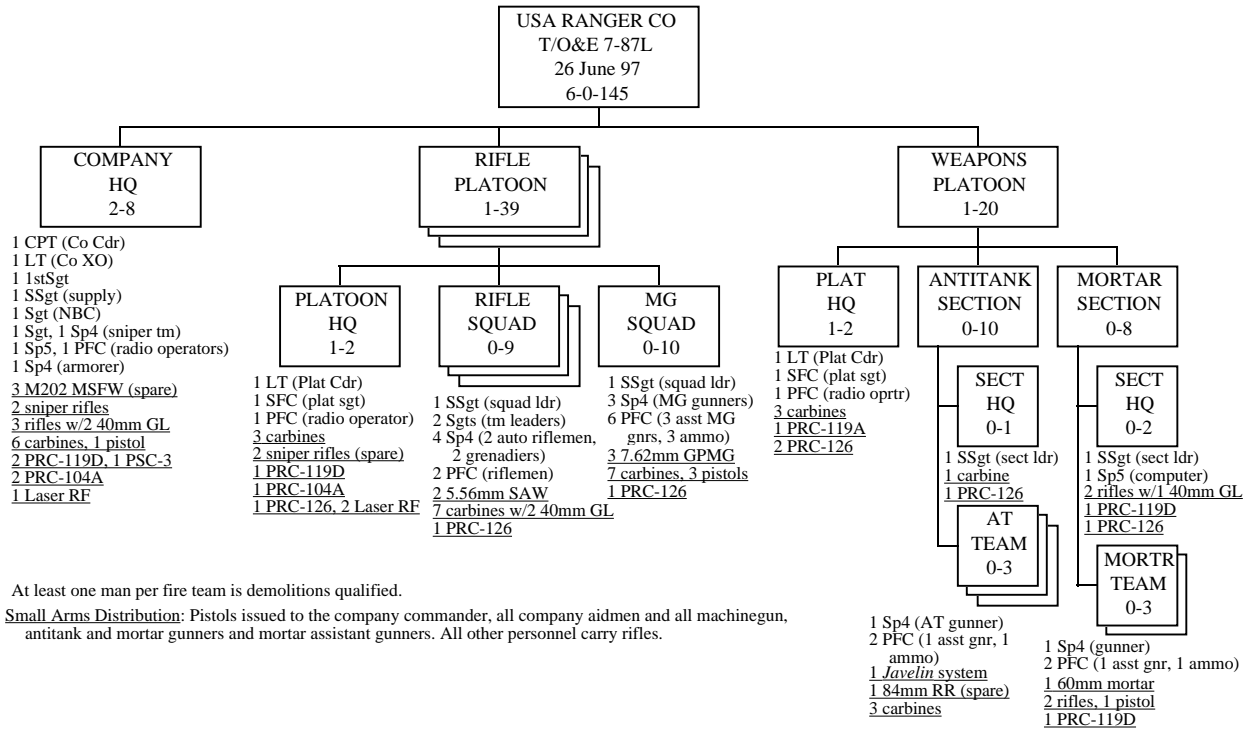

**Notes:**

Source: Department of the Army Tables of Organization 7-85L "Ranger Infantry Battalion;" 7-86L "Headquarters and Headquarters Company, Ranger Battalion" and 7-87L "Rifle Company, Ranger Battalion" (Washington DC 26 June 1997).

Appendix 10.25

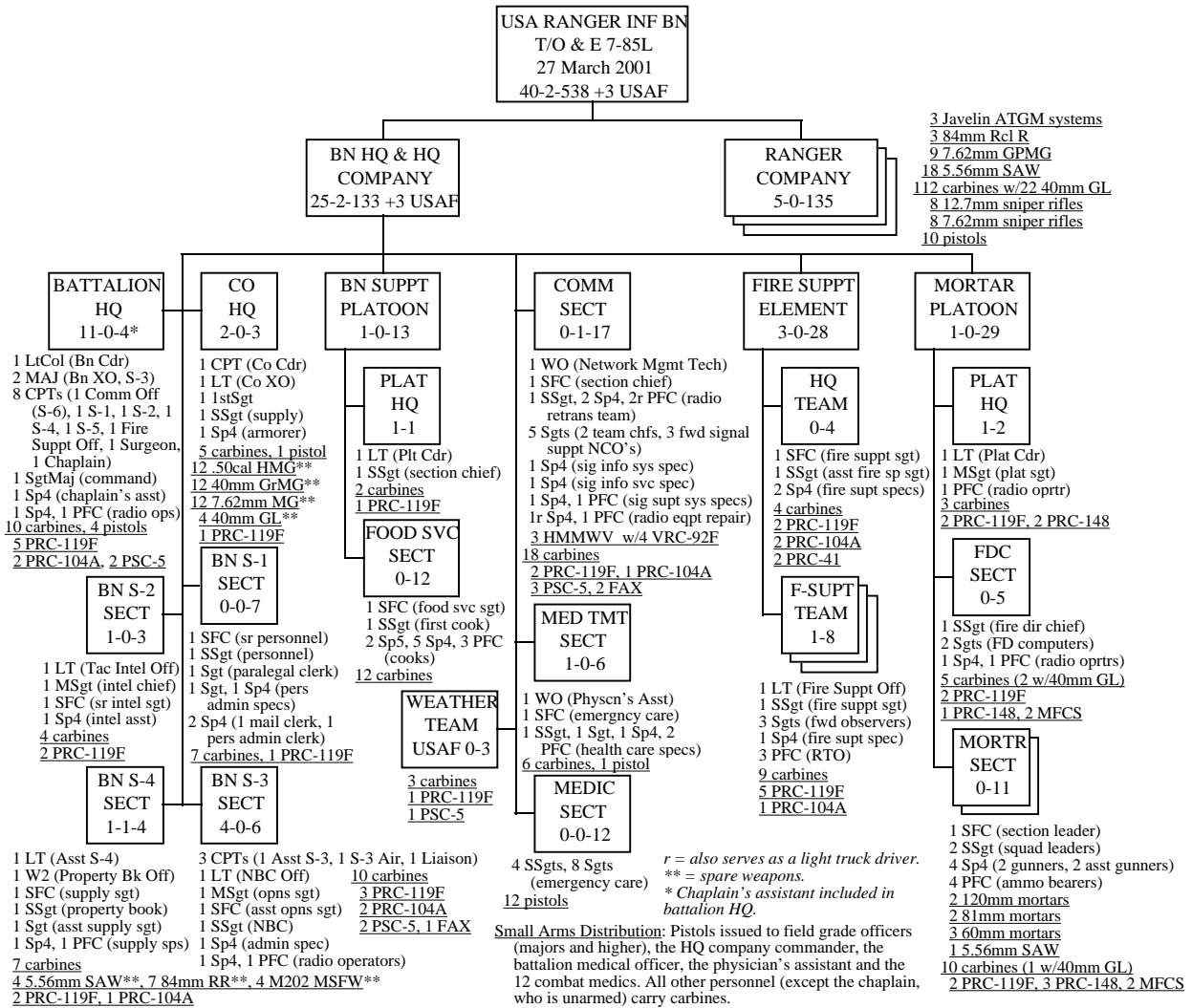

Appendix 10.25 (continued)

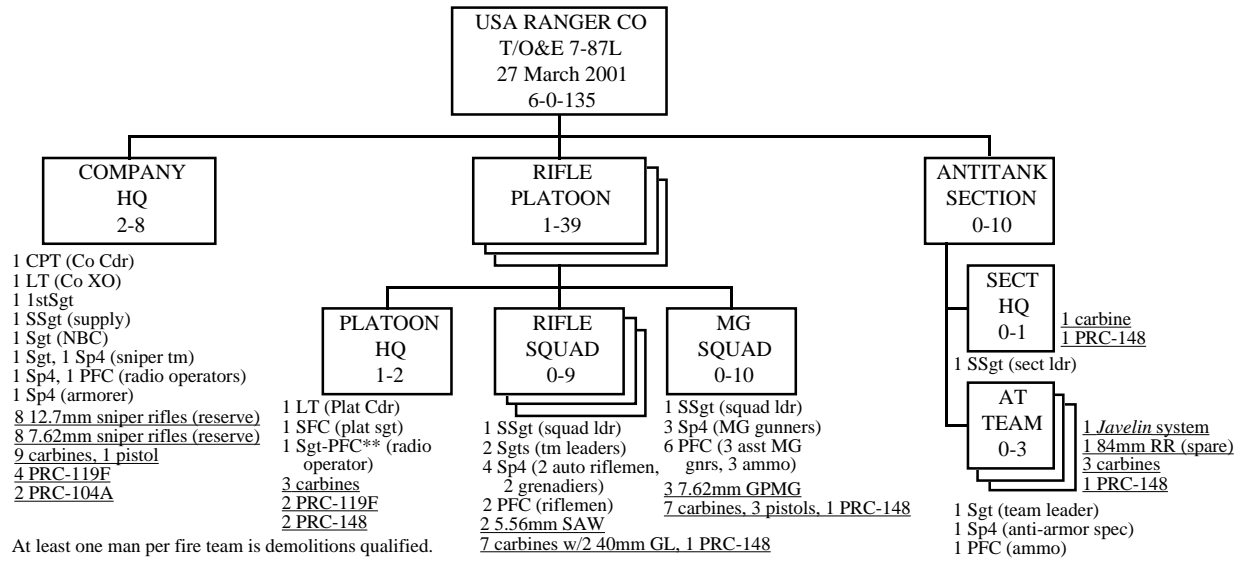

Notes:

**Source:** Department of the Army Tables of Organization 7-85L "Ranger Infantry Battalion;" 7-86L "Headquarters and Headquarters Company, Ranger Battalion" and 7-87L "Rifle Company, Ranger Battalion" (Washington DC 27 March 2001).



# APPENDIX 11

## Appendix 11.1

Notes: Figures in brackets indicate augmentation personnel (supplied only when ordered). In the M and P series tables, the command post security section in the headquarters company headquarters (19 enlisted men) is a "contingent" element (manned only in wartime).

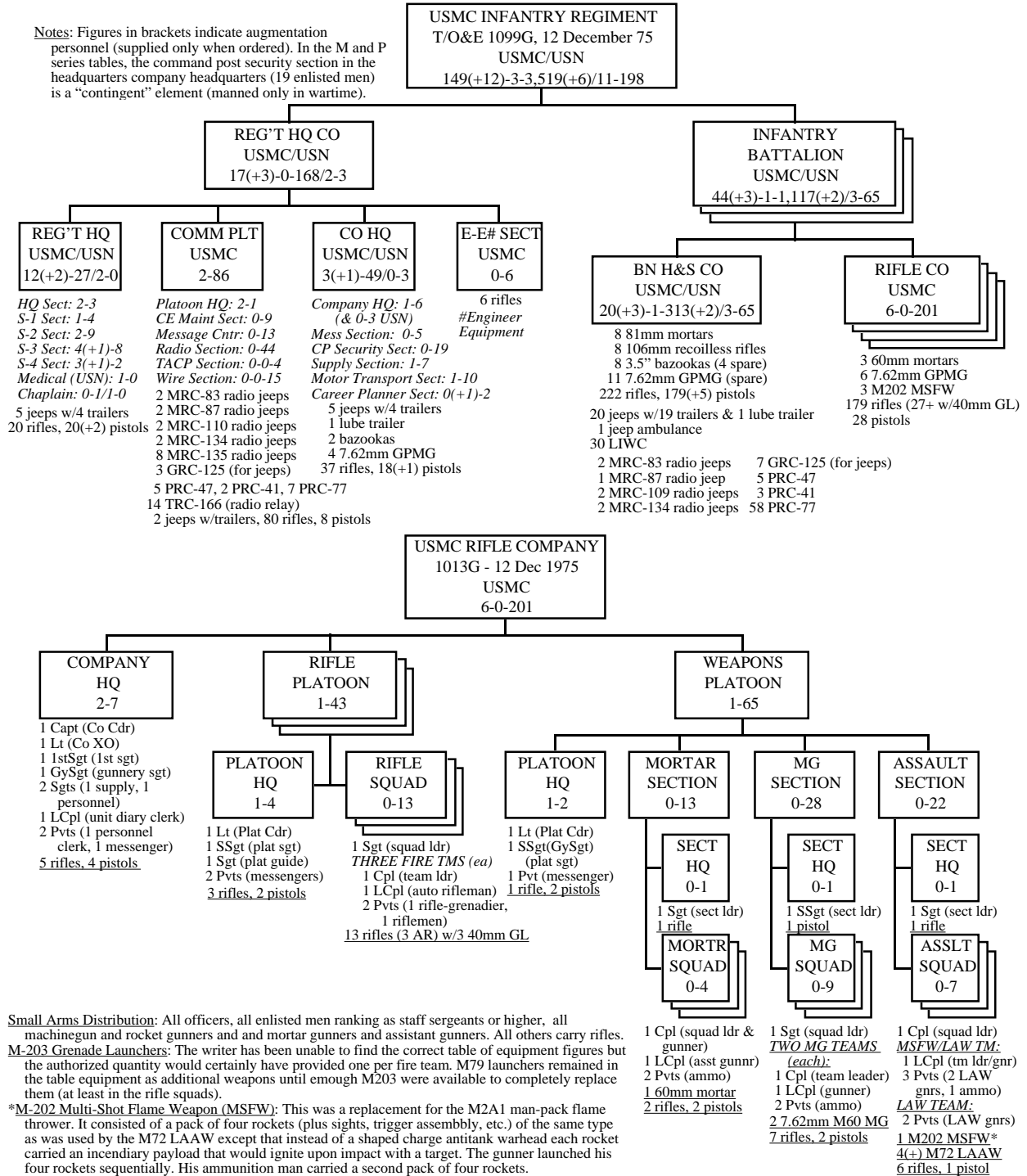

Notes:

**1013P Rifle Company:** Same as "G" series above except that one messenger per platoon headquarters and one ammunition man per 60mm mortar squad and machinegun team is "contingent" (furnished only in wartime). It totals six officers and 189 men.

**1013M Rifle Company:** Same as the "P" series except that the entire 60mm mortar section is "contingent" only.

**Source:** Marine Corps Tables of Organization 1013G "Rifle Company, Infantry Battalion, Infantry Regiment, Marine Division, FMF;" 1038G "Infantry Battalion, Infantry Regiment, Marine Division, FMF;" and 1099G "Infantry Regiment, Marine Division, FMF;" (Washington DC dated 12 December 1975).

## Appendix 11.2

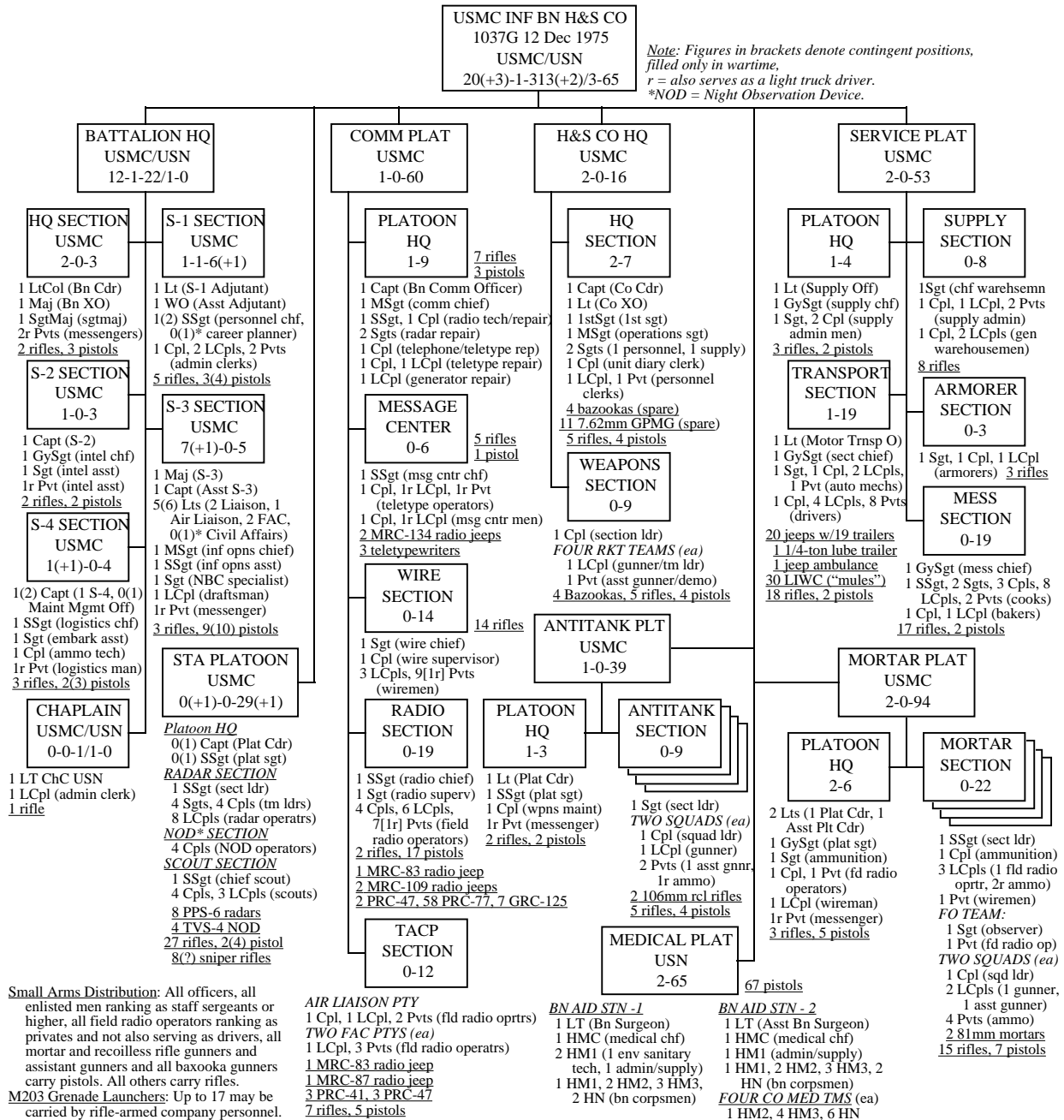

Notes: The STA Platoon is the Surveillance and Target Acquisition Platoon.

Figures in brackets indicate "augmentation" personnel. Their positions are filled only on orders from Headquarters Marine Corps.

**1037P H&S Company:** Same as the "G" series except that one ammunition man per 81mm mortar squad and 106mm recoilless squad, four radar teams from the radar section of the STA platoon (two sergeants, two corporals and two lance corporals in all), and four scouts from the STA platoon (two corporals and two lance corporals) are "contingent" men (their positions are filled in wartime only). The company has 21 Marine and three Navy officers and 285 Marine and 65 Navy enlisted.

**1037M H&S Company:** Same as the "P" tables except that three of the four bazooka teams in the weapons section, company headquarters are also "contingent" positions (billets).

**Changes:** By August 1977 Headquarters Marine Corps had implemented changes that involved the removal of the lance corporal generator repairman from the communication platoon headquarters, the addition of eight operators (four corporals and four lance corporals) to the radio section, the elimination of the weapons section from H&S company headquarters and the rearming of the antitank platoon with *Dragon* missiles (increasing its strength to one officer and 70 men).

**Source:** Marine Corps Table of Organization 1037G "Headquarters and Service Company, Infantry Battalion, Infantry Regiment, Marine Division, FMF" (Washington DC dated 12 December 1975).

### Appendix 11.3

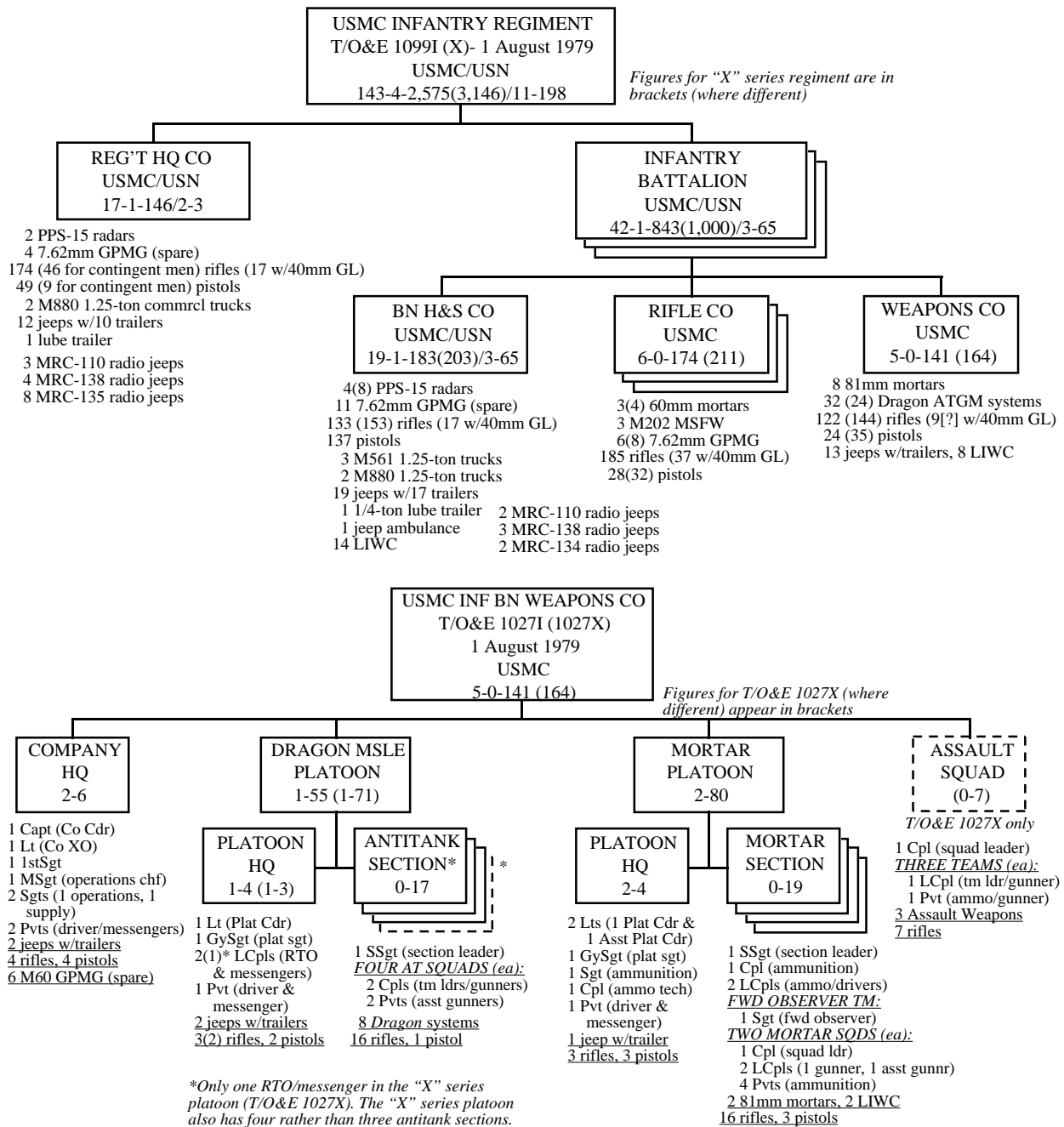

**Notes:**

Due to the unavailability of complete table of equipment data for these units the data for motor vehicles and communication equipment should be regarded as only approximate.

**Sources:** Marine Corps Tables of Organization 1027I and 1027X "Weapons Company, Infantry Battalion, Infantry Regiment, Marine Division, FMF;" 1038I and 1038X "Infantry Battalion, Infantry Regiment, Marine Division, FMF;" (all Washington DC 1 August 1979 and 18 December 1980) and 1099M "Infantry Regiment, Marine Division, FMF;" (Washington DC dated 18 December 1980).

Appendix 11.4

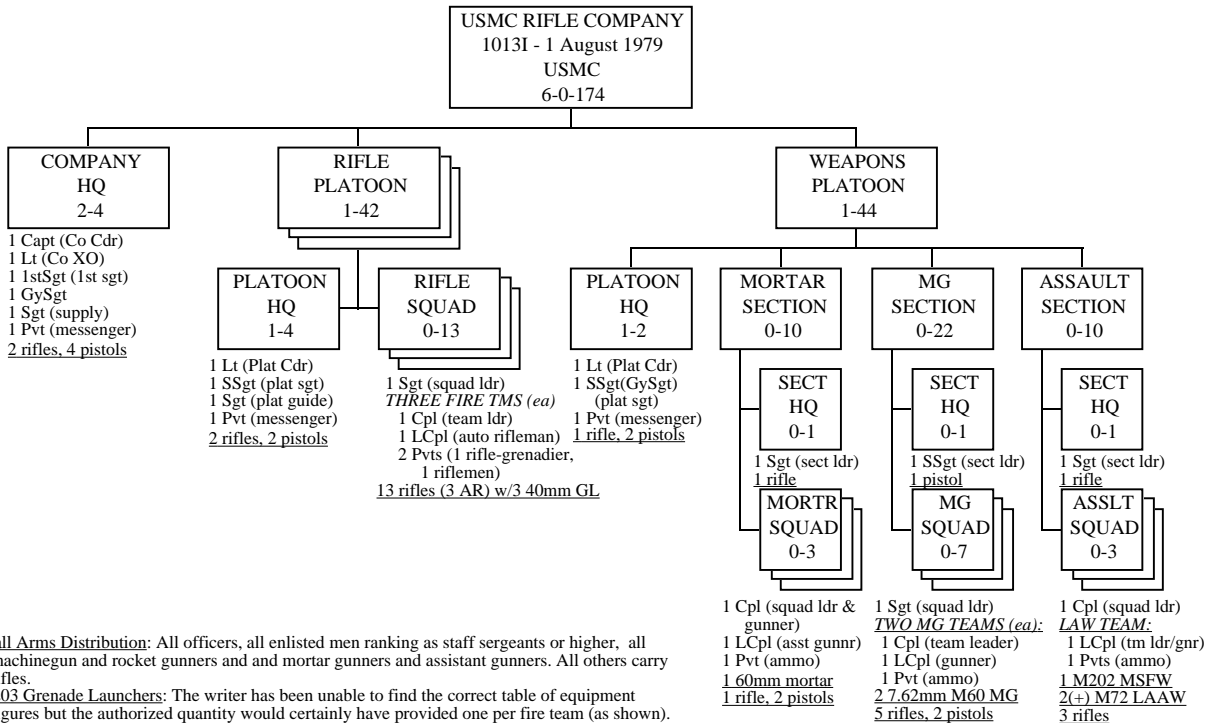
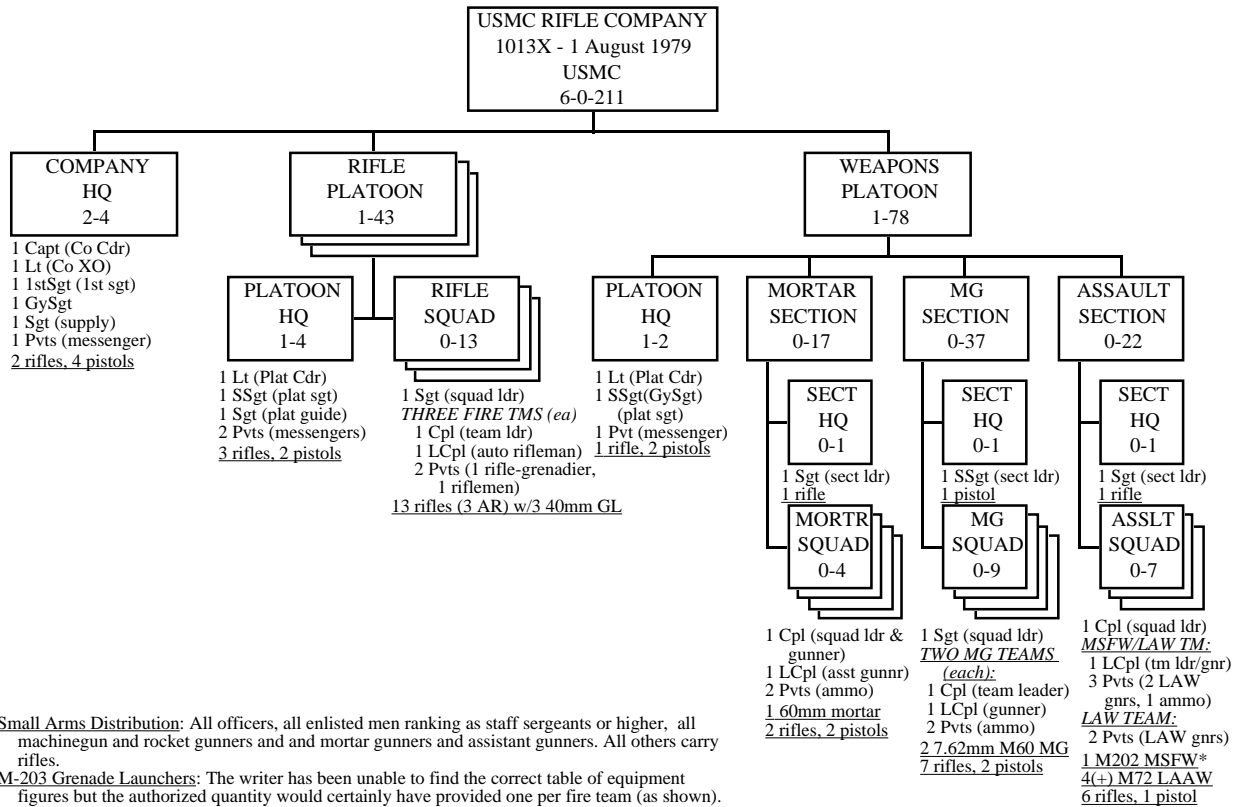

Notes:

Sources: Marine Corps Tables of Organization 1013X and 10131 "Rifle Company, Infantry Battalion, Infantry Regiment, Marine Division, FMF" (Washington DC dated 1 August 1979 and 18 December 1980).

## Appendix 11.5

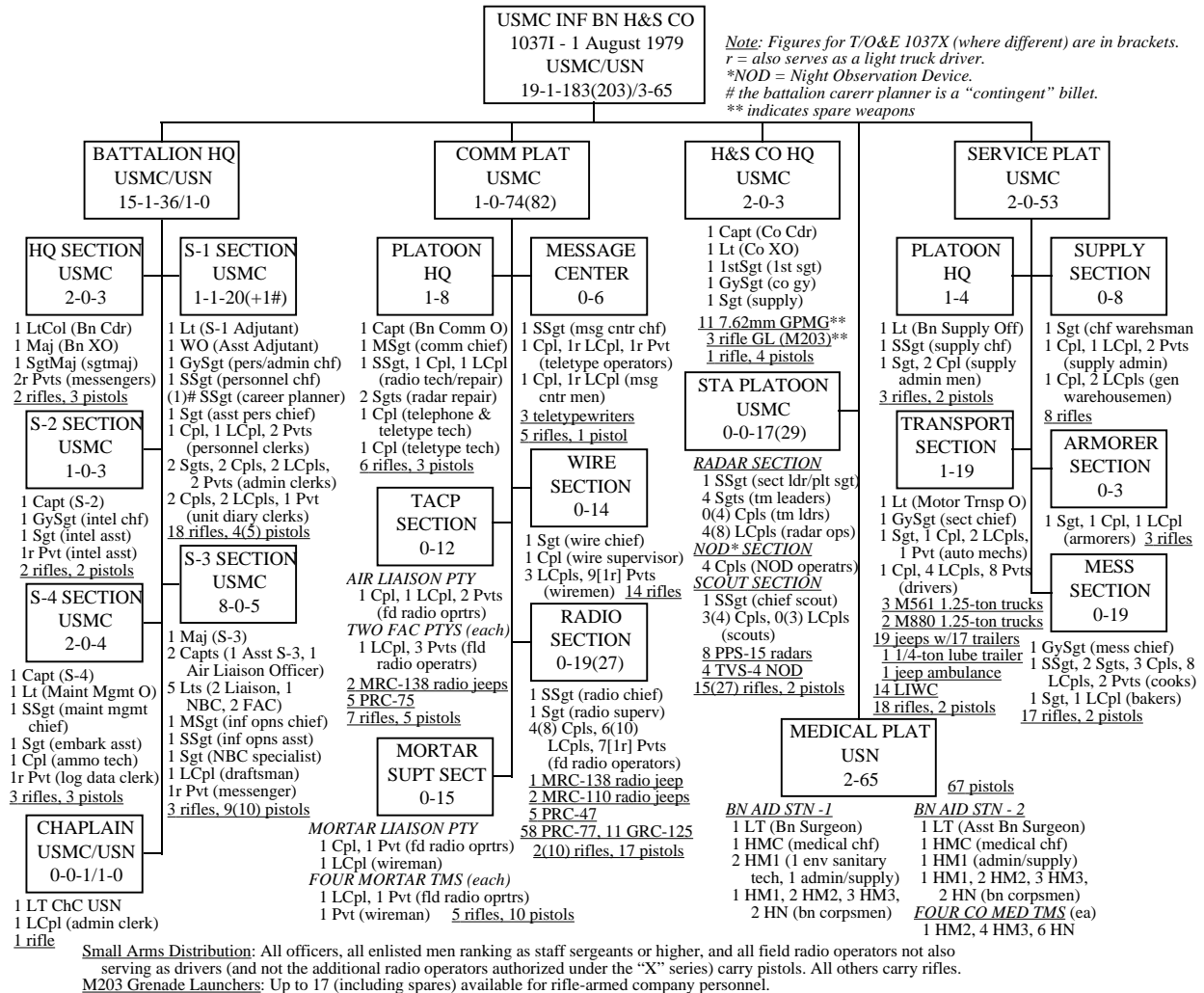

**Notes:**

Due to the unavailability of complete table of equipment data for this unit the data for motor vehicles and communication equipment should be regarded as only approximate.

**Sources:** Marine Corps Tables of Organization 1037I and 1037X "Headquarters and Service Company, Infantry Battalion, Infantry Regiment, Marine Division, FMF" (Washington DC dated 1 August 1979 and 18 December 1980).

## Appendix 11.7

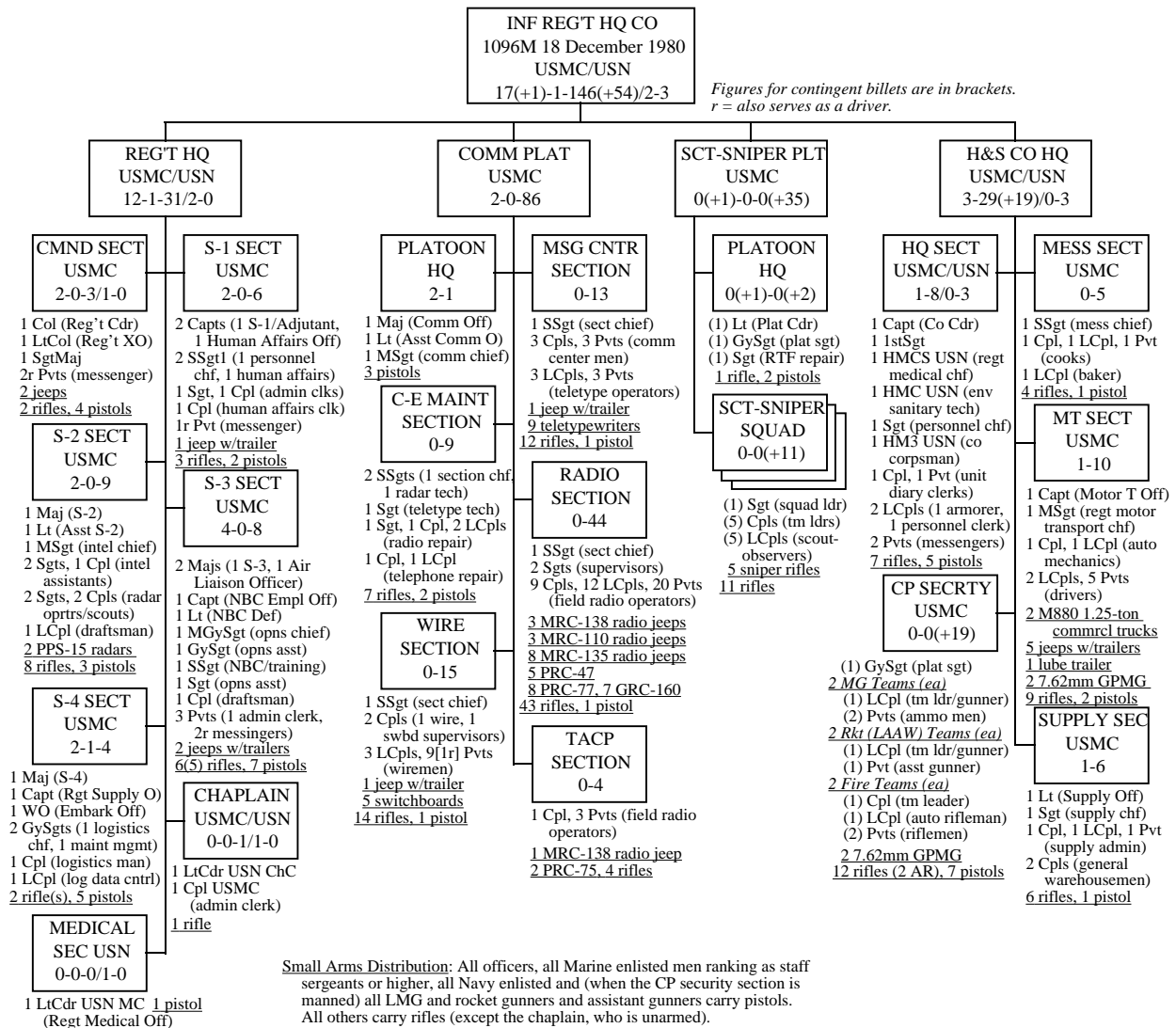

**Notes:**

Due to the unavailability of complete table of equipment data for this unit the data for motor vehicles and communication equipment should be regarded as only approximate.

**Source:** Marine Corps Tables of Organization 1099G "Headquarters Company, Infantry Regiment, Marine Division, FMF;" (Washington DC dated 18 December 1980).

### Appendix 11.8

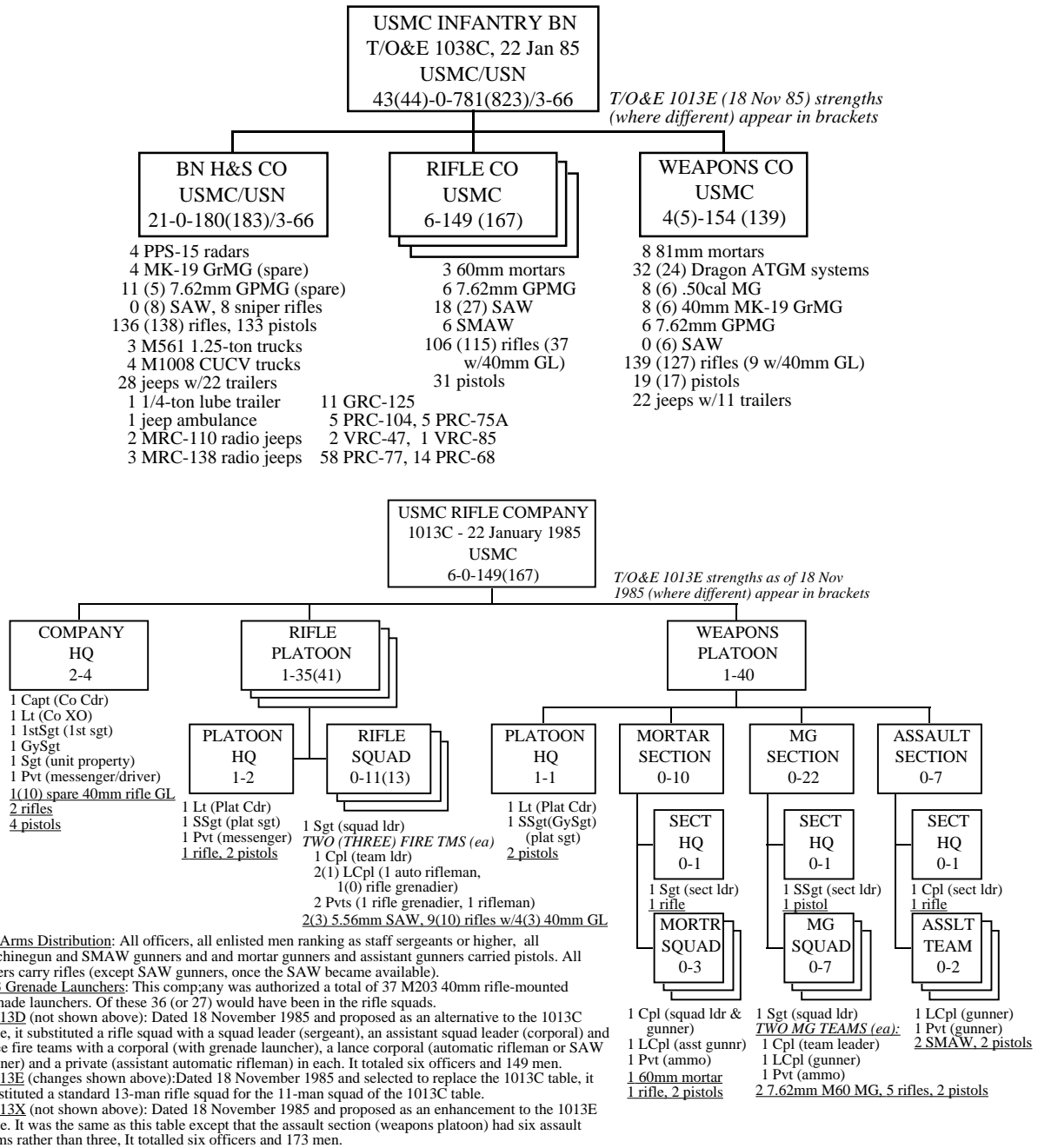

**Notes:**

Due to the unavailability of complete table of equipment data for these units the data for motor vehicles and communication equipment should be regarded as only approximate.

**Source:** Marine Corps Tables of Organization 1013C "Rifle Company, Infantry Battalion, Infantry Regiment, Marine Division, FMF" and 1038C "Infantry Battalion, Infantry Regiment, Marine Division, FMF;" (all Washington DC 22 January 1985).

## Appendix 11.9

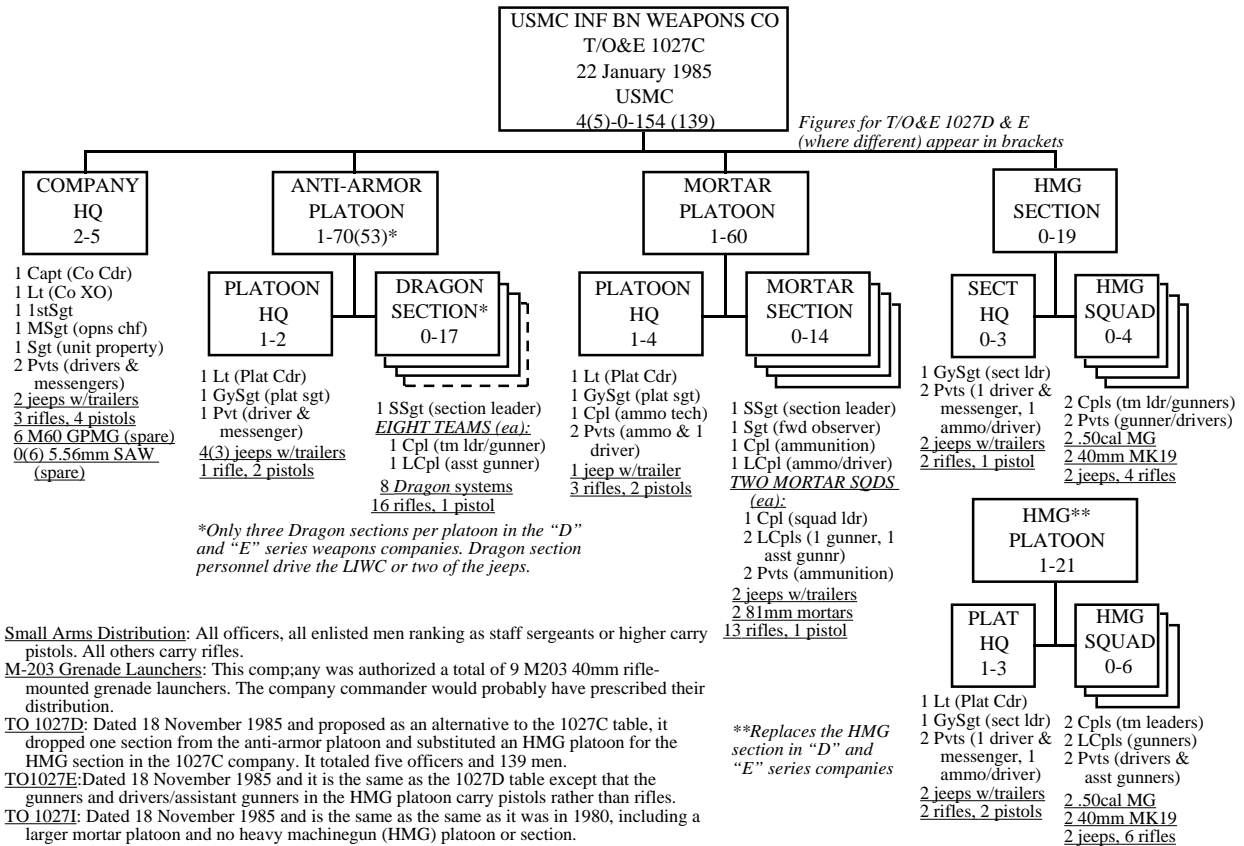

**Small Arms Distribution:** All officers, all enlisted men ranking as staff sergeants or higher carry pistols. All others carry rifles.

**M-203 Grenade Launchers:** This company was authorized a total of 9 M203 40mm rifle-mounted grenade launchers. The company commander would probably have prescribed their distribution.

**TO 1027D:** Dated 18 November 1985 and proposed as an alternative to the 1027C table, it dropped one section from the anti-armor platoon and substituted an HMG platoon for the HMG section in the 1027C company. It totaled five officers and 139 men.

**TO 1027E:** Dated 18 November 1985 and it is the same as the 1027D table except that the gunners and drivers/assistant gunners in the HMG platoon carry pistols rather than rifles.

**TO 1027I:** Dated 18 November 1985 and is the same as the same as it was in 1980, including a larger mortar platoon and no heavy machinegun (HMG) platoon or section.

**Notes:**

Due to the unavailability of complete table of equipment data for this unit the data for motor vehicles and communication equipment should be regarded as only approximate.

**Source:** Marine Corps Tables of Organization 1027C "Weapons Company, Infantry Battalion, Infantry Regiment, Marine Division, FMF" (Washington DC 22 January 1985).



## Appendix 11.10

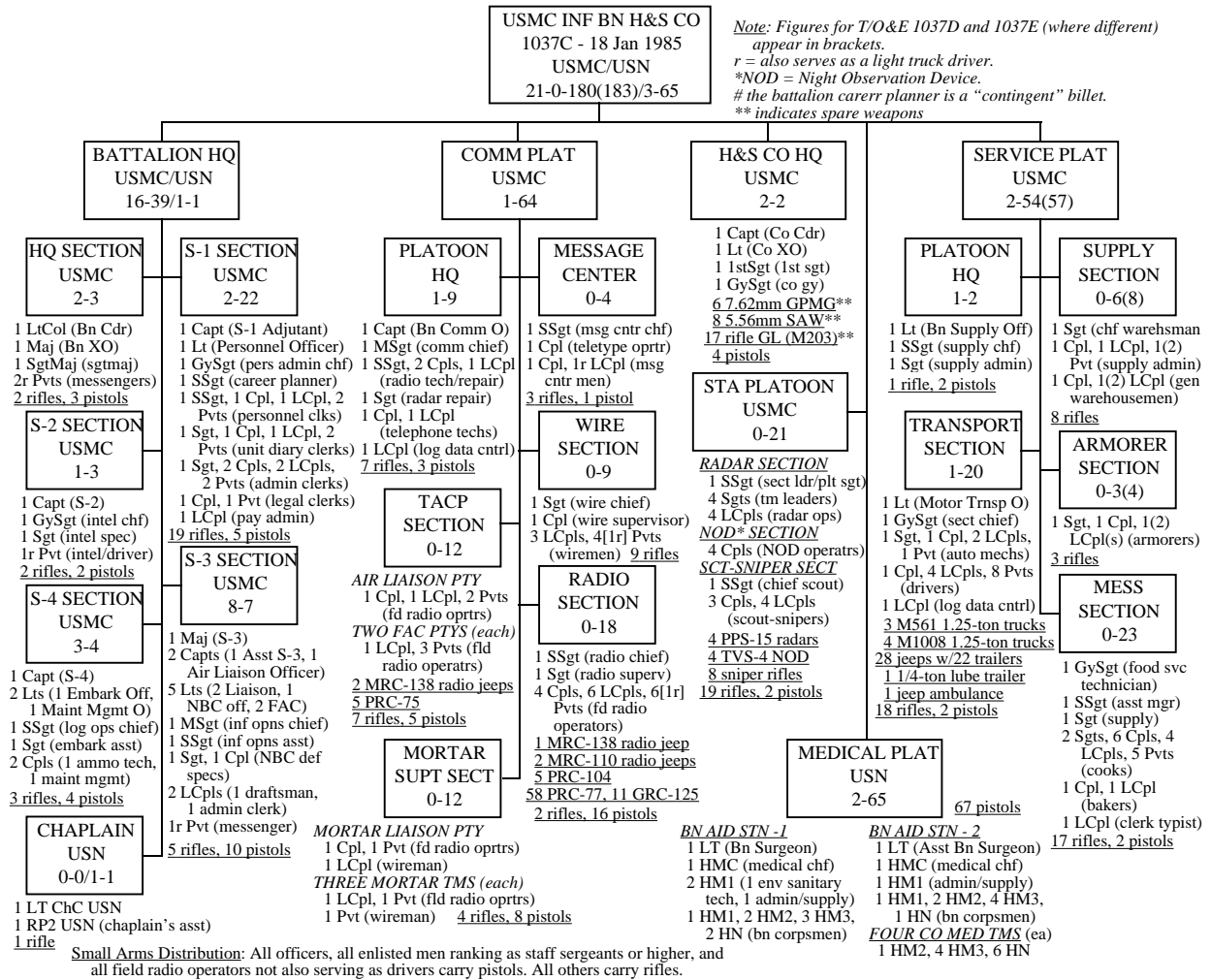

**Notes:**

Due to the unavailability of complete table of equipment data for this unit the data for motor vehicles and communication equipment should be regarded as only approximate.

Source: Marine Corps Tables of Organization 1037C "Headquarters and Service Company, Infantry Battalion, Infantry Regiment, Marine Division, FMF" (Washington DC 22 January 1985).

### Appendix 11.11

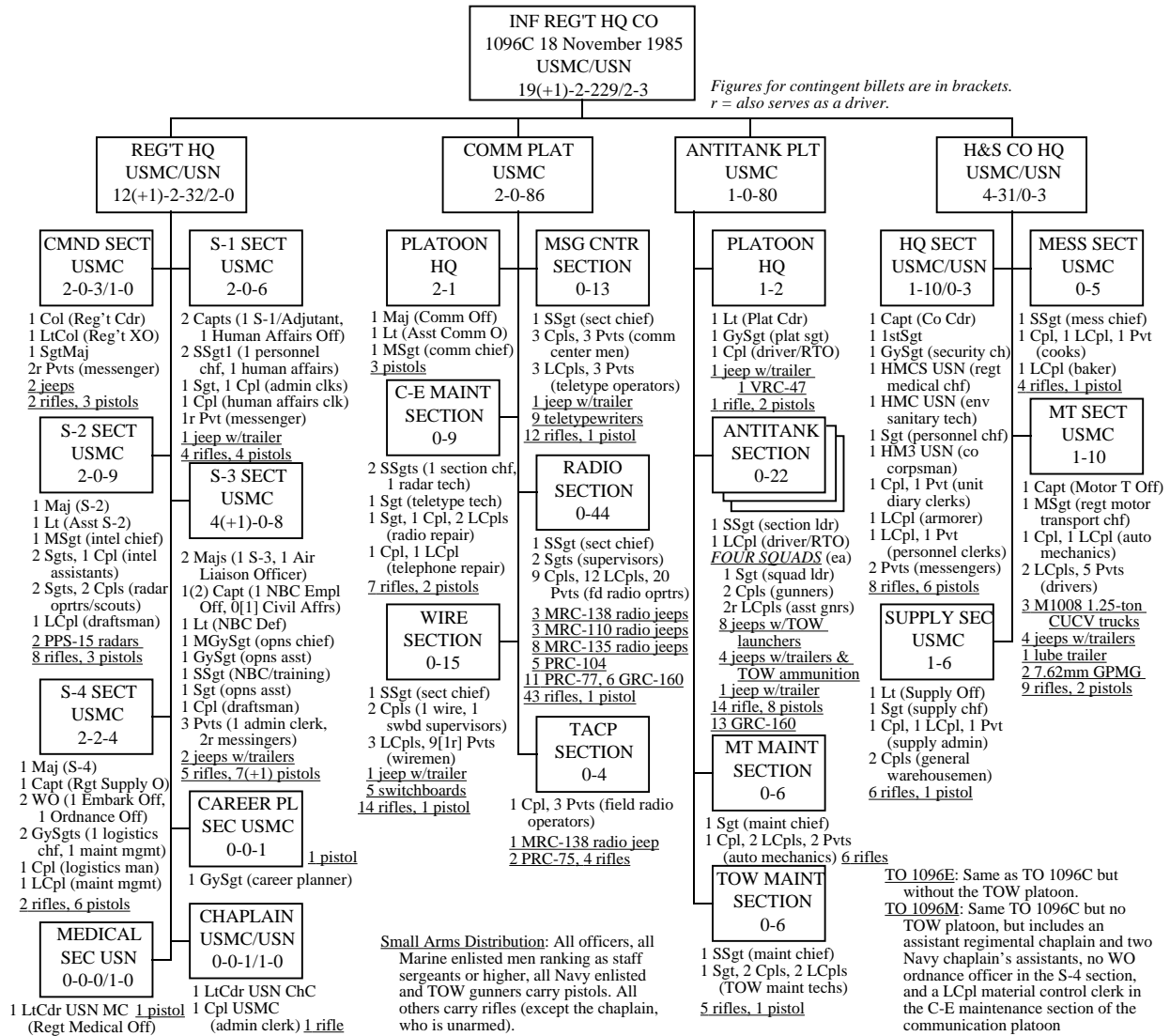

**Notes:**

Due to the unavailability of complete table of equipment data for this unit the data for motor vehicles and communication equipment should be regarded as only approximate.

Source: Marine Corps Tables of Organization 1096C "Headquarters Company, Infantry Regiment, Marine Division, FMF" (Washington DC 22 January 1985).

**Appendix 11.12**

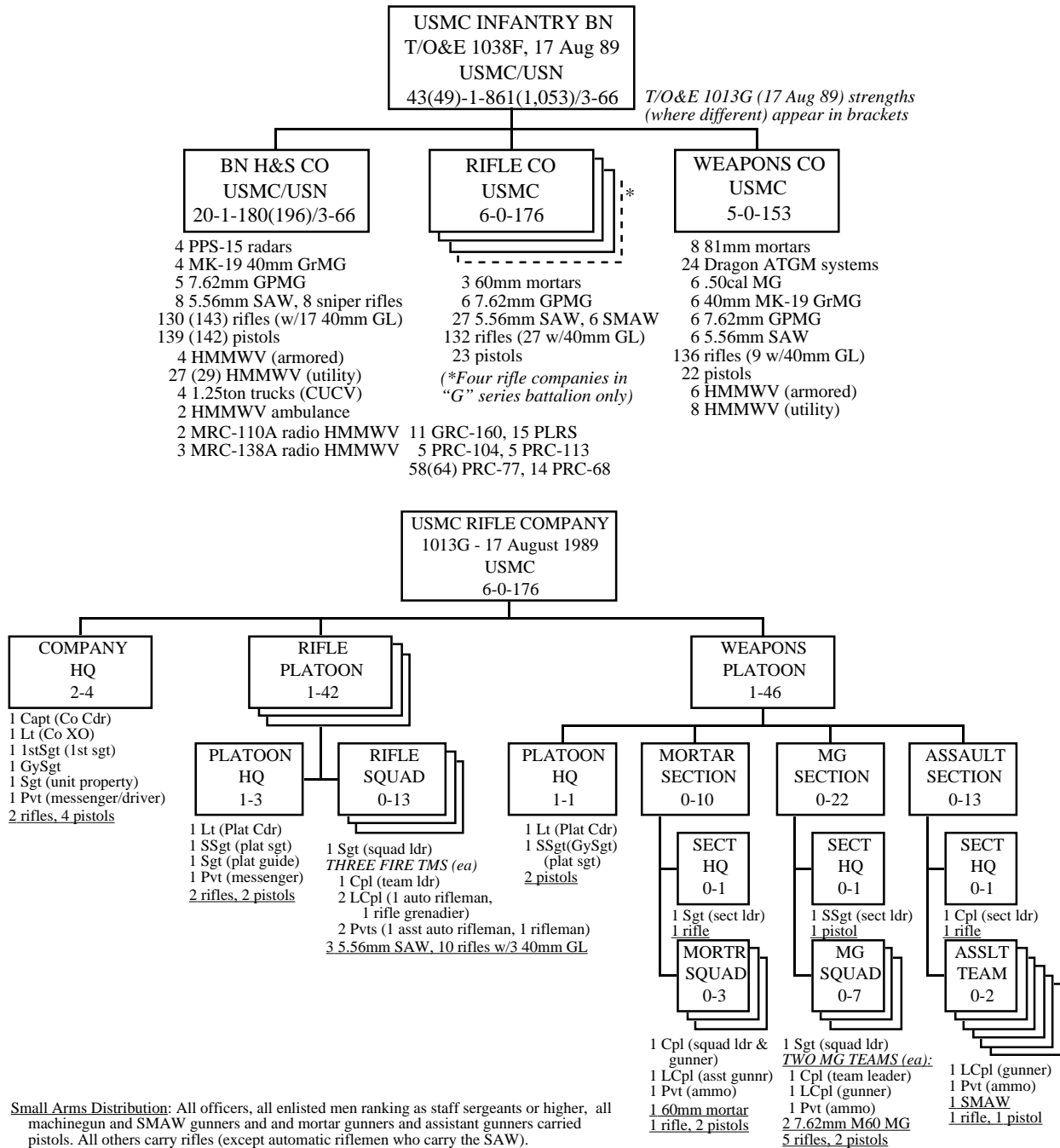

Small Arms Distribution: All officers, all enlisted men ranking as staff sergeants or higher, all machinegun and SMAW gunners and and mortar gunners and assistant gunners carried pistols. All others carry rifles (except automatic riflemen who carry the SAW).

**Notes:**

Due to the unavailability of complete table of equipment data for these units the data for motor vehicles and communication equipment should be regarded as only approximate.

Source: Marine Corps Tables of Organization 1013F or G "Rifle Company, Infantry Battalion, Infantry Regiment, Marine Division, FMF;" and 1038F and 1038G "Infantry Battalion, Infantry Regiment, Marine Division, FMF;" (all Washington DC 17 August 1989).

**Appendix 11.13**

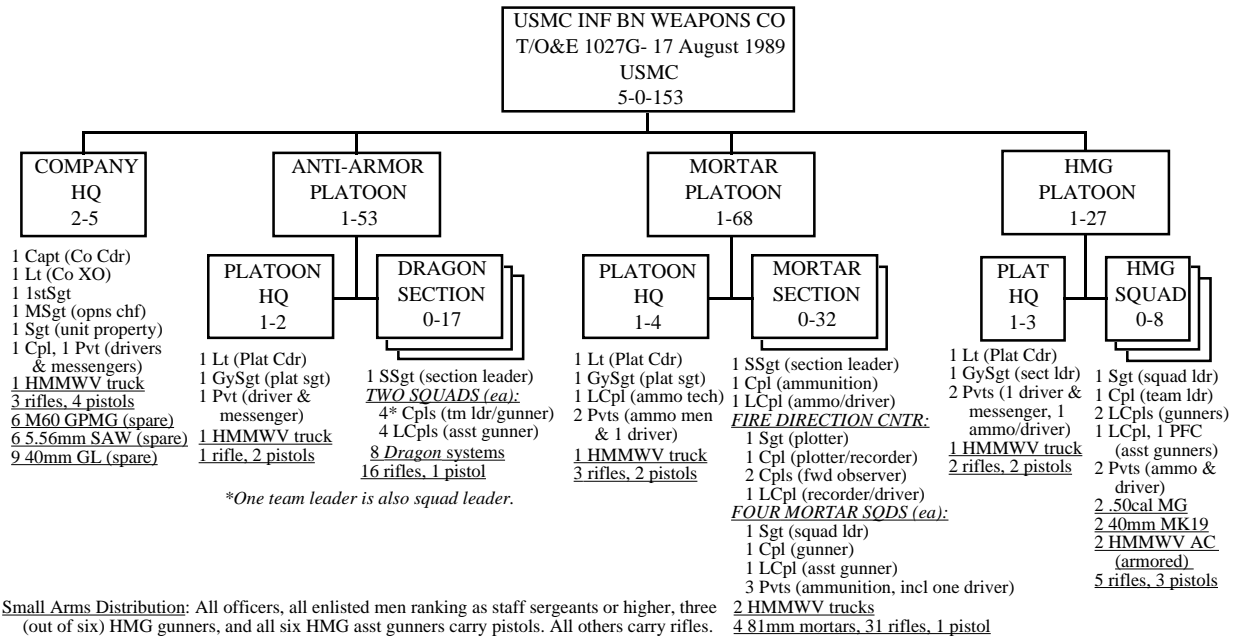

**Notes:**

Due to the unavailability of complete table of equipment data for this unit the data for motor vehicles and communication equipment should be regarded as only approximate.

Source: Marine Corps Tables of Organization 1027F or G "Weapons Company, Infantry Battalion, Infantry Regiment, Marine Division, FMF" (Washington DC 17 August 1989).

## Appendix 11.14

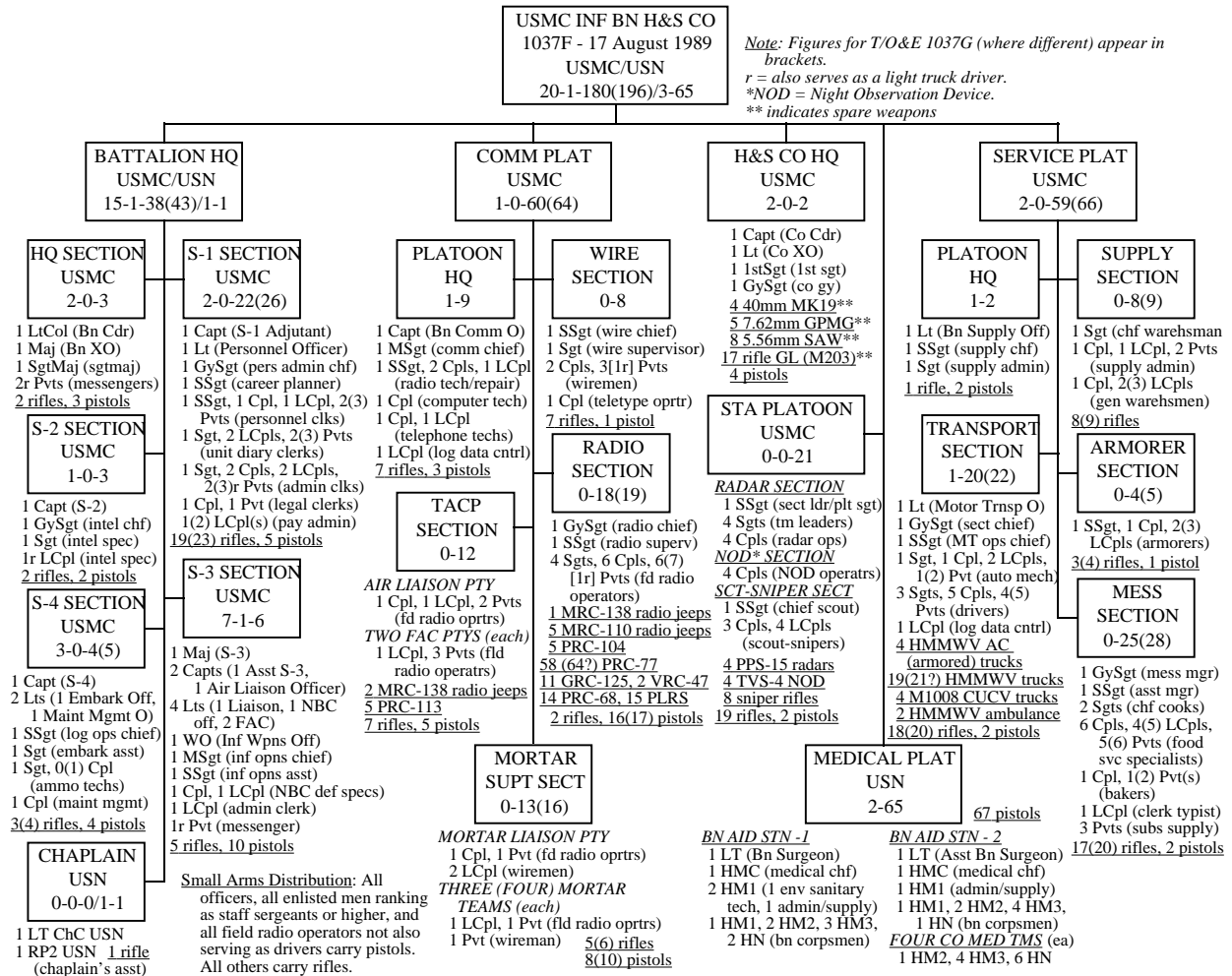

Notes:  
 Due to the unavailability of complete table of equipment data for this unit the data for motor vehicles and communication equipment should be regarded as only approximate.  
 Source: Marine Corps Tables of Organization 1037F and 1037G "Headquarters and Service Company, Infantry Battalion, Infantry Regiment, Marine Division, FMF" (Washington DC 17 August 1989).

### Appendix 11.15

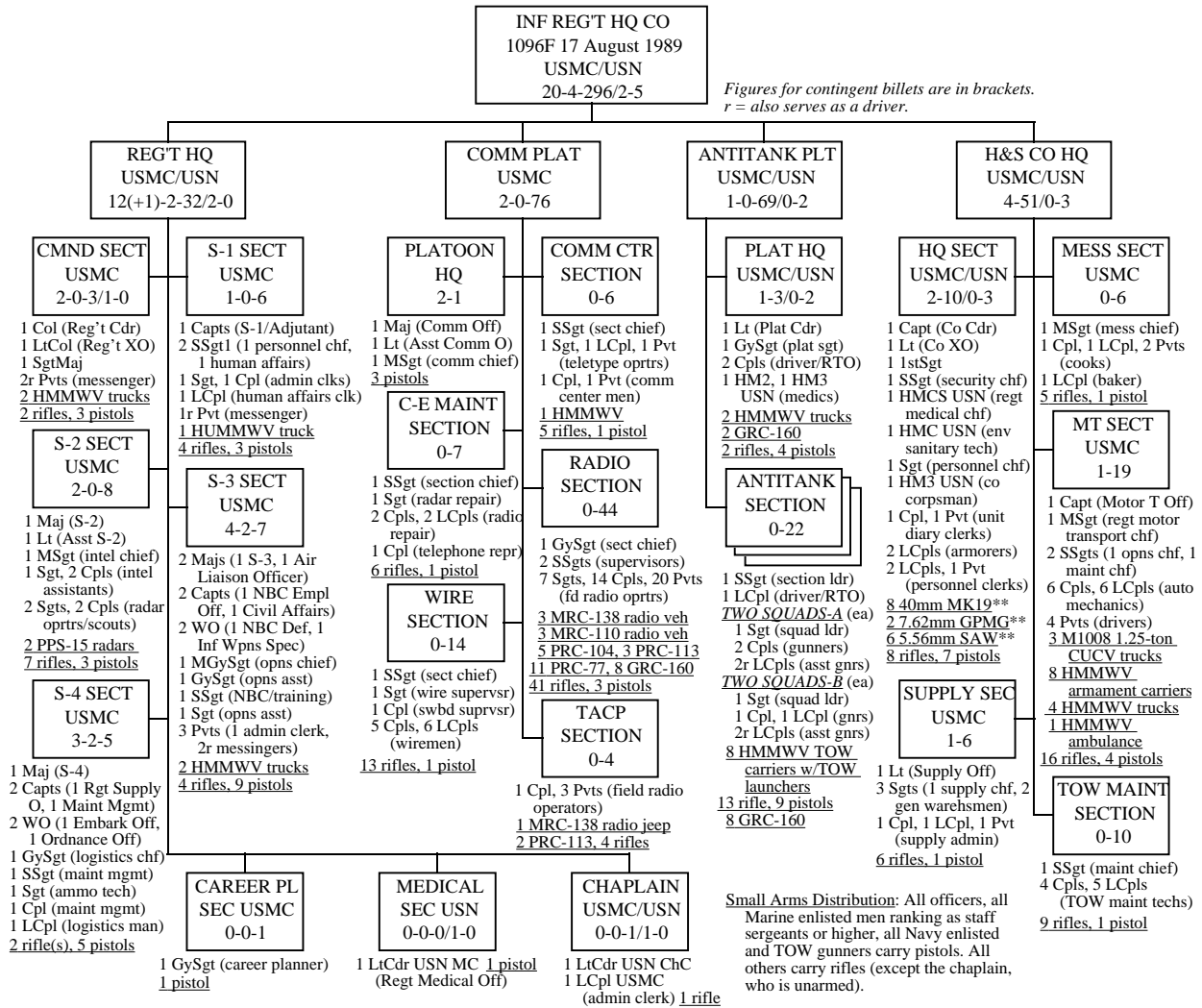

**Notes:**

Due to the unavailability of complete table of equipment data for this unit the data for motor vehicles and communication equipment should be regarded as only approximate.

**Source:** Marine Corps Tables of Organization 1096F "Headquarters Company, Infantry Regiment, Marine Division, FMF" (Washington DC 17 August 1989).

Appendix 11.16

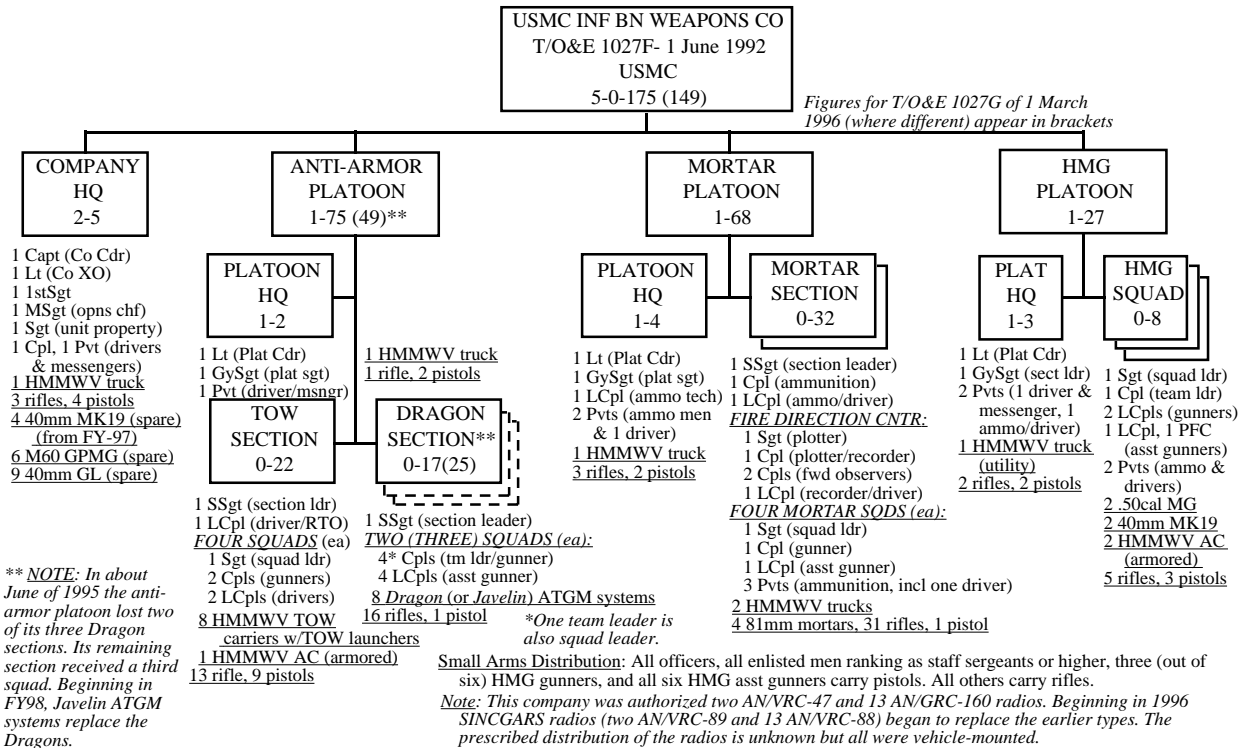
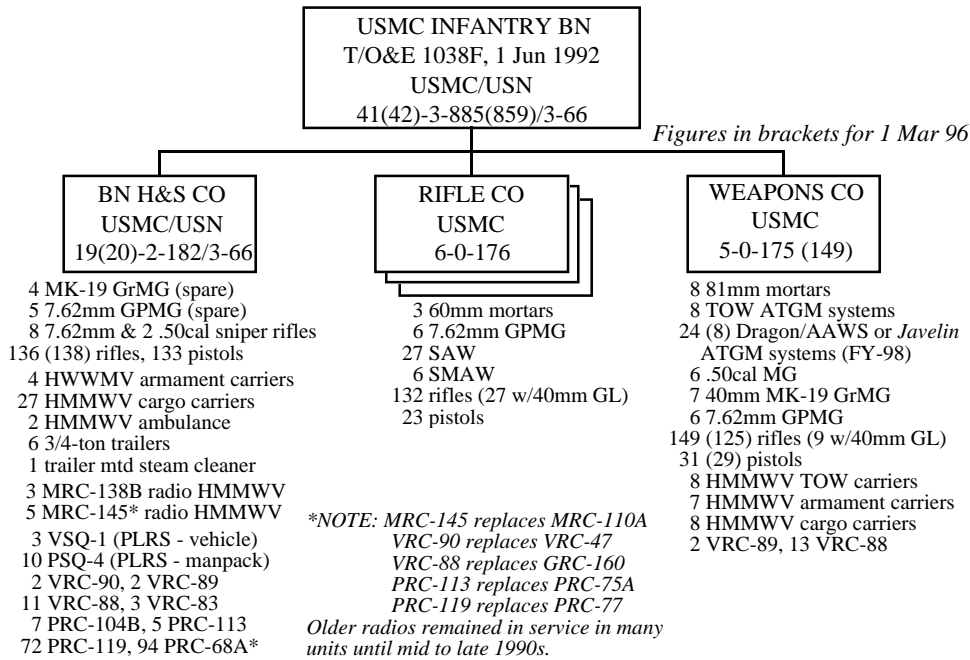

Notes:

Source: Marine Corps Tables of Organization 1027F "Weapons Company, Infantry Battalion, Infantry Regiment, Marine Division, FMF" and 1038F "Infantry Battalion, Infantry Regiment, Marine Division, FMF;" (all Washington DC 1 June 1992 and 1 March 1996).

**Appendix 11.17**

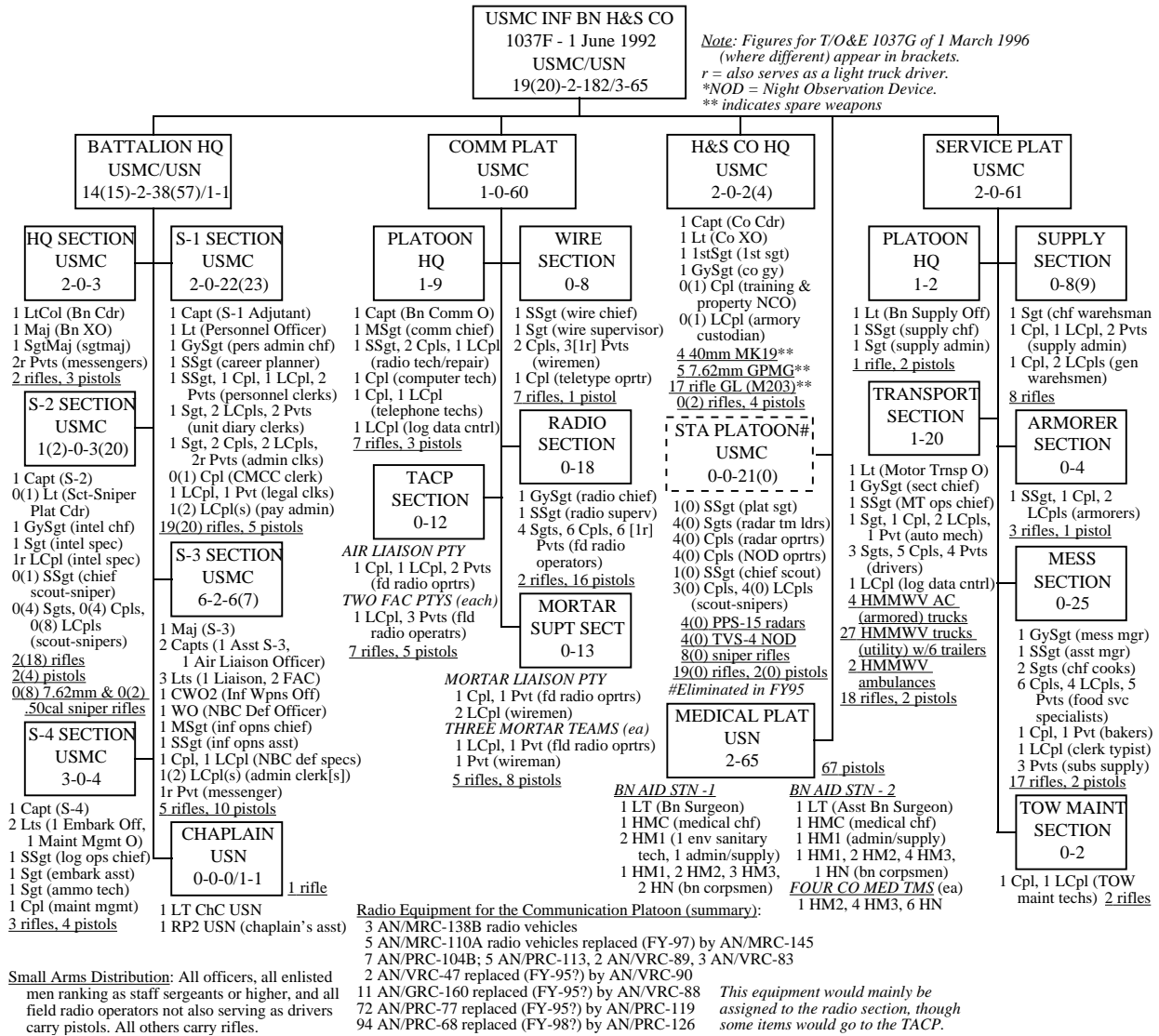

**Notes:**

**Source:** Marine Corps Tables of Organization 1037F and 1037G "Headquarters and Service Company, Infantry Battalion, Infantry Regiment, Marine Division, FMF" (Washington DC 1 June 1992 and 1 March 1996).



## APPENDIX 12

### Appendix 12.1

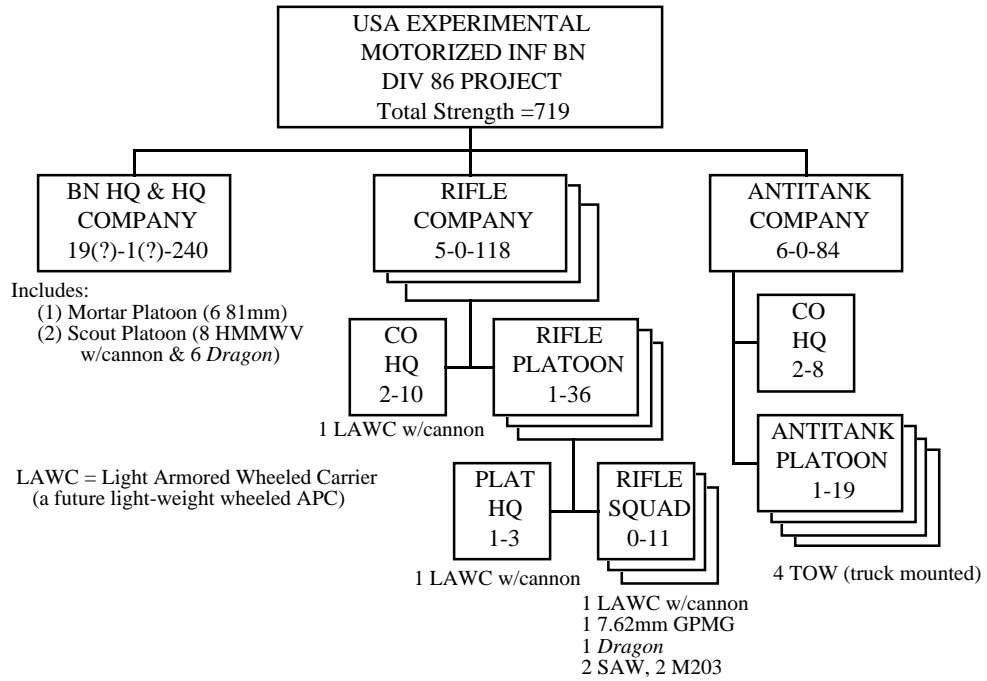

Notes:

Source: John L. Romjue, *A History of Army 86 Vol. II* (Fort Monroe VA, US Army TRADOC 1982) pp. 25-57 and 130-131.

Appendix 12.2

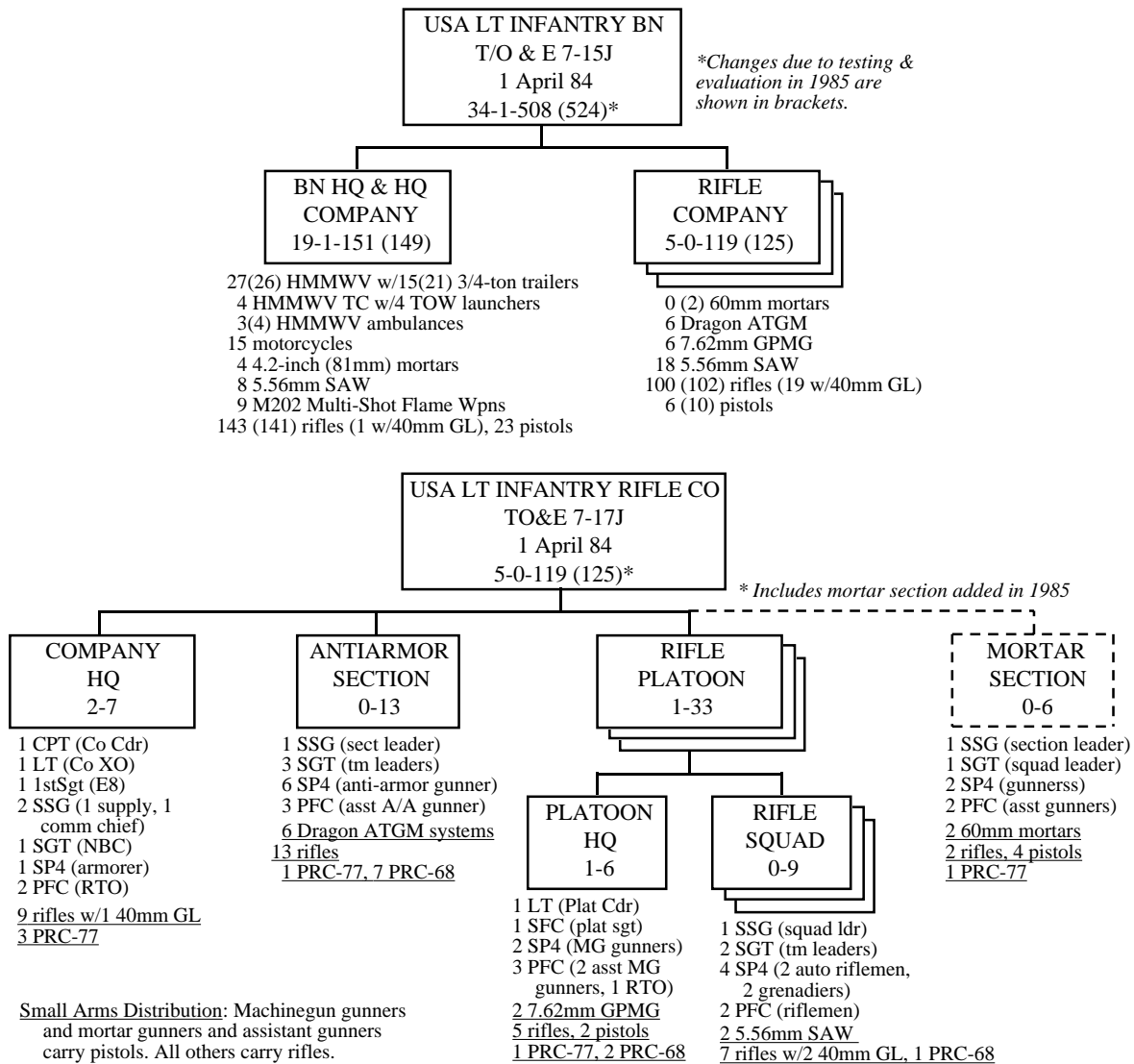

Notes:

Source: Department of the Army Tables of Organization 7-15J4 "Light Infantry Battalion, Light Infantry Division (AOE)" and 7-17J4 "Rifle Company, Infantry Battalion, Light Infantry Division (AOE)" (Washington DC 1 April 1984 with changes through 1985).

Appendix 12.3

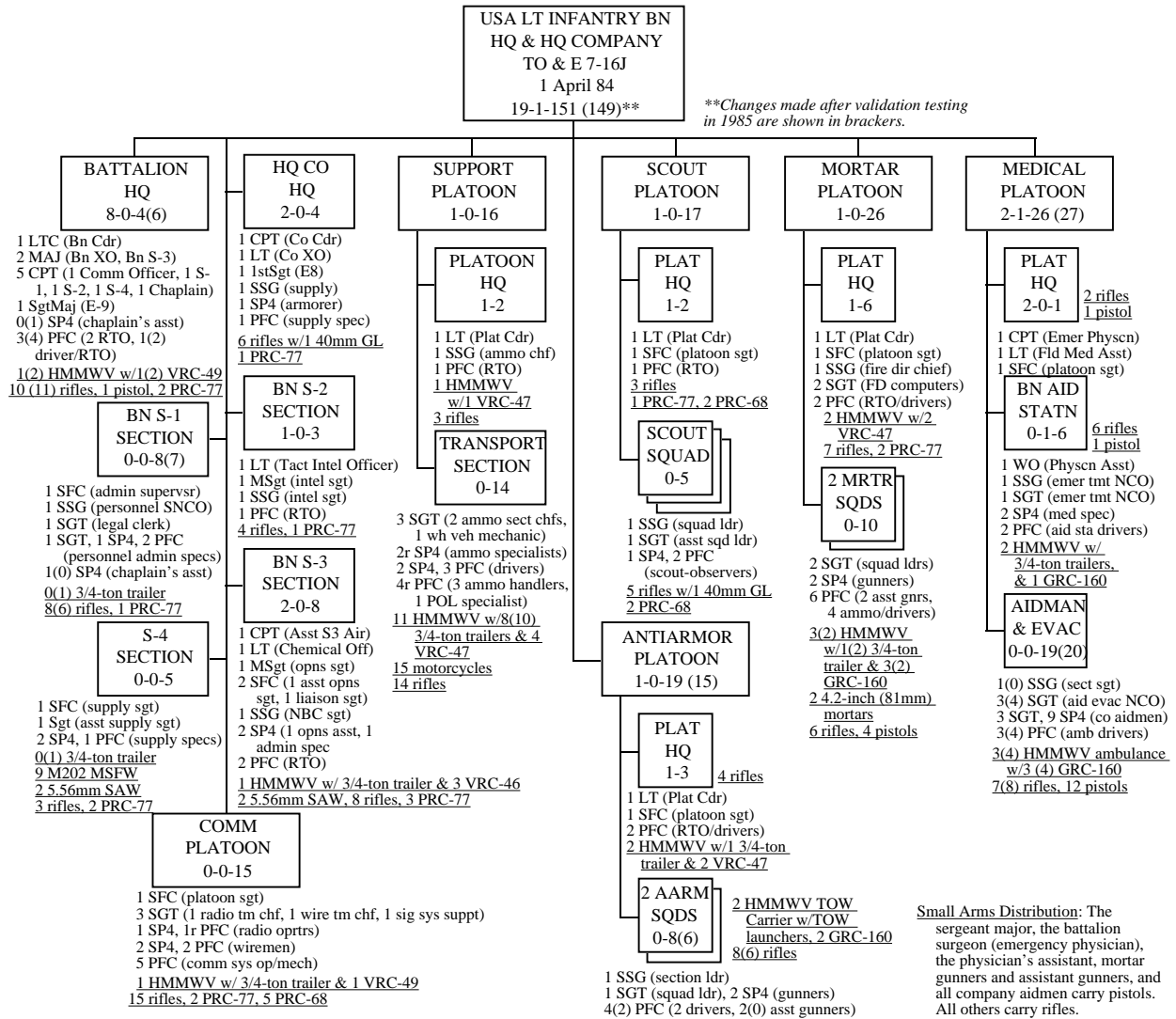

Notes:

Source: Department of the Army Table of Organization 7-16J4 "Headquarters and Headquarters Company, Infantry Battalion, Light Infantry Division (AOE)" (Washington DC 1 April 1984 with changes through 1985)

## Appendix 12.4

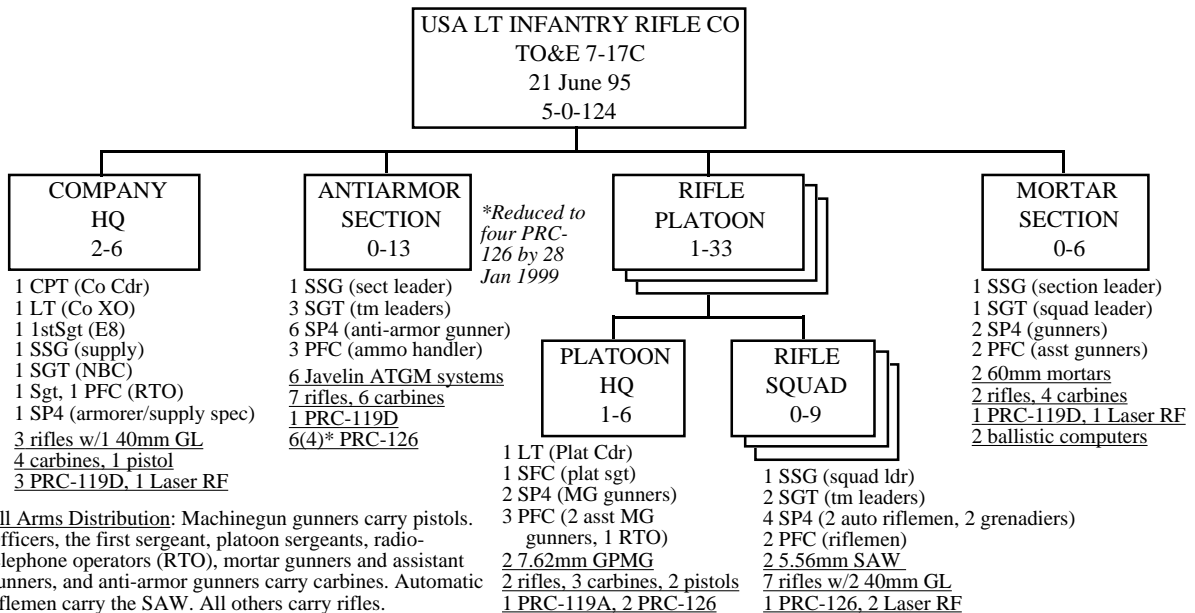
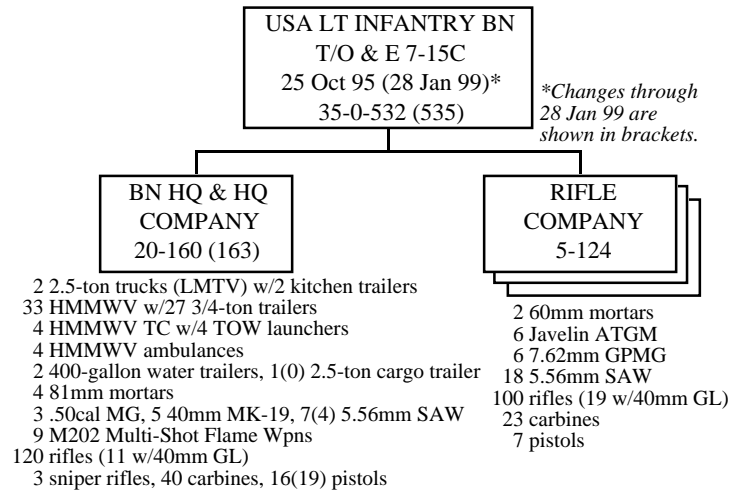

**Small Arms Distribution:** Machinegun gunners carry pistols. Officers, the first sergeant, platoon sergeants, radio-telephone operators (RTO), mortar gunners and assistant gunners, and anti-armor gunners carry carbines. Automatic riflemen carry the SAW. All others carry rifles.

**Notes:**

**Source:** Department of the Army Tables of Organization 7-15C "Light Infantry Battalion" (Washington DC 25 October 1995 with changes through 28 June 1999) and 7-17C "Rifle Company, Infantry Battalion, Light Infantry Division" (Washington DC 21 June 1995 with changes through 6 June 1999).

## Appendix 12.5

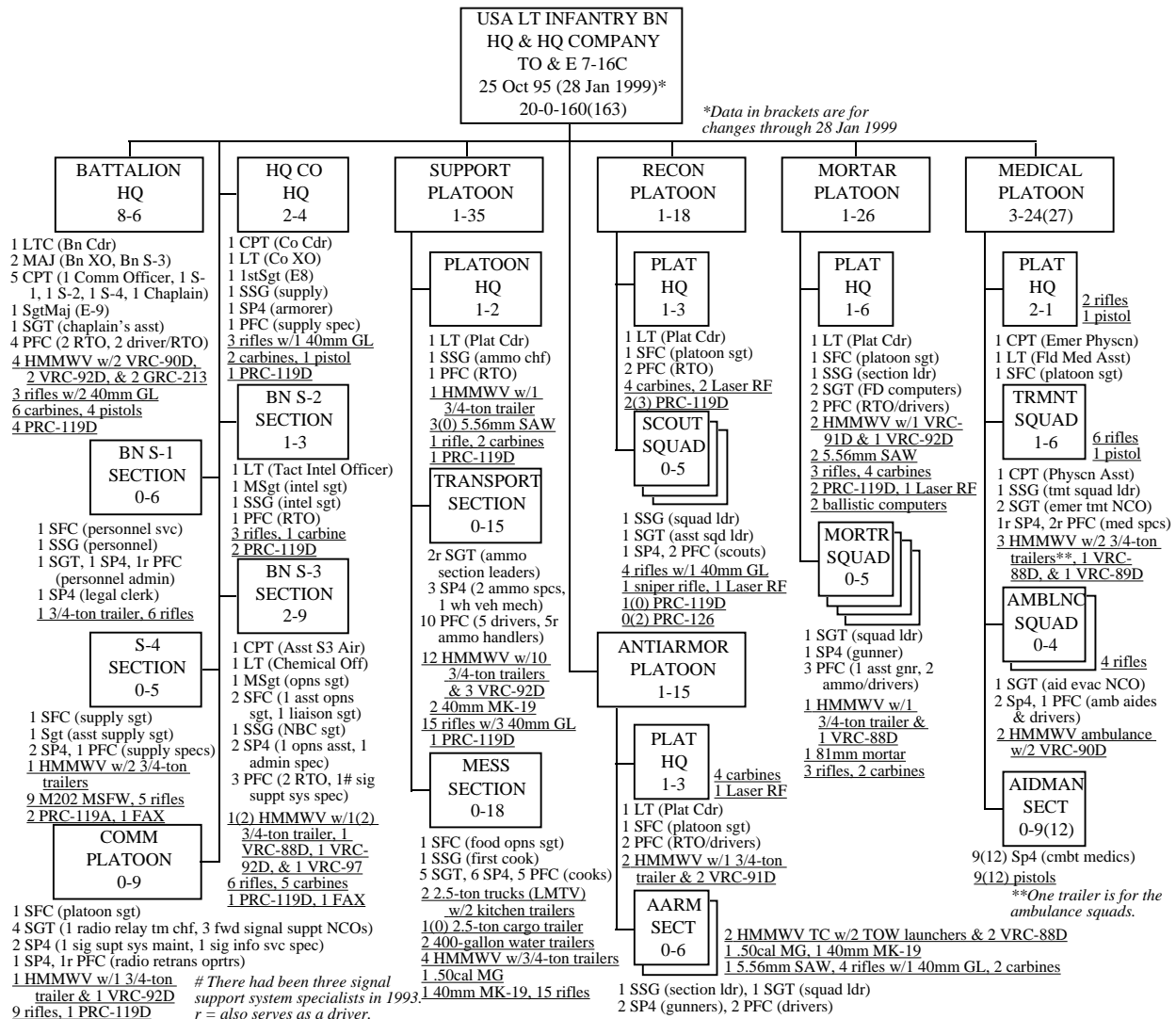

**Small Arms Distribution:** Field grade officers, the company commander, the battalion surgeon, the company commander, the battalion surgeon, the sergeant major and the combat medics all carry pistols. All other officers (except the chaplain who is unarmed and the field medical assistant, who has a rifle), the first sergeant, the operations sergeant, the anti-armor, mortar and recon platoon sergeants, all RTO (except in the S2 section), all anti-armor gunners and all mortar gunners and assistant gunners carry carbines. All others carry rifles (except those assigned to carry a SAW).

**Notes:**

The actual table of organization for the light infantry battalion HHC places the sergeant chaplain's assistant in a separate "unit ministry team" even though the same table also carried the chaplain himself as a member of battalion headquarters. Because the chaplain's assistant was the only member of the unit ministry team and because he naturally would work closely with the chaplain in the battalion headquarters I have omitted the unit ministry team and placed the chaplain's assistant in the battalion headquarters. The headquarters also includes the chaplain's HMMWV and AN/VRC90D radio. The battalion commander and executive officer each have a HMMWV with a driver, a radio operator (RTO), an AN/VRC-92d, an AN/GRC-213 and (for dismounted use) two AN/PRC-119D. The sergeant major has the fourth HMMWV (with AN/VRC-90D).

**Source:** Department of the Army Table of Organization 7-16C "Headquarters and Headquarters Company, Infantry Battalion, Light Infantry Division" (Washington DC 25 October 1995 with changes through 28 January 1999).

**Appendix 12.6**

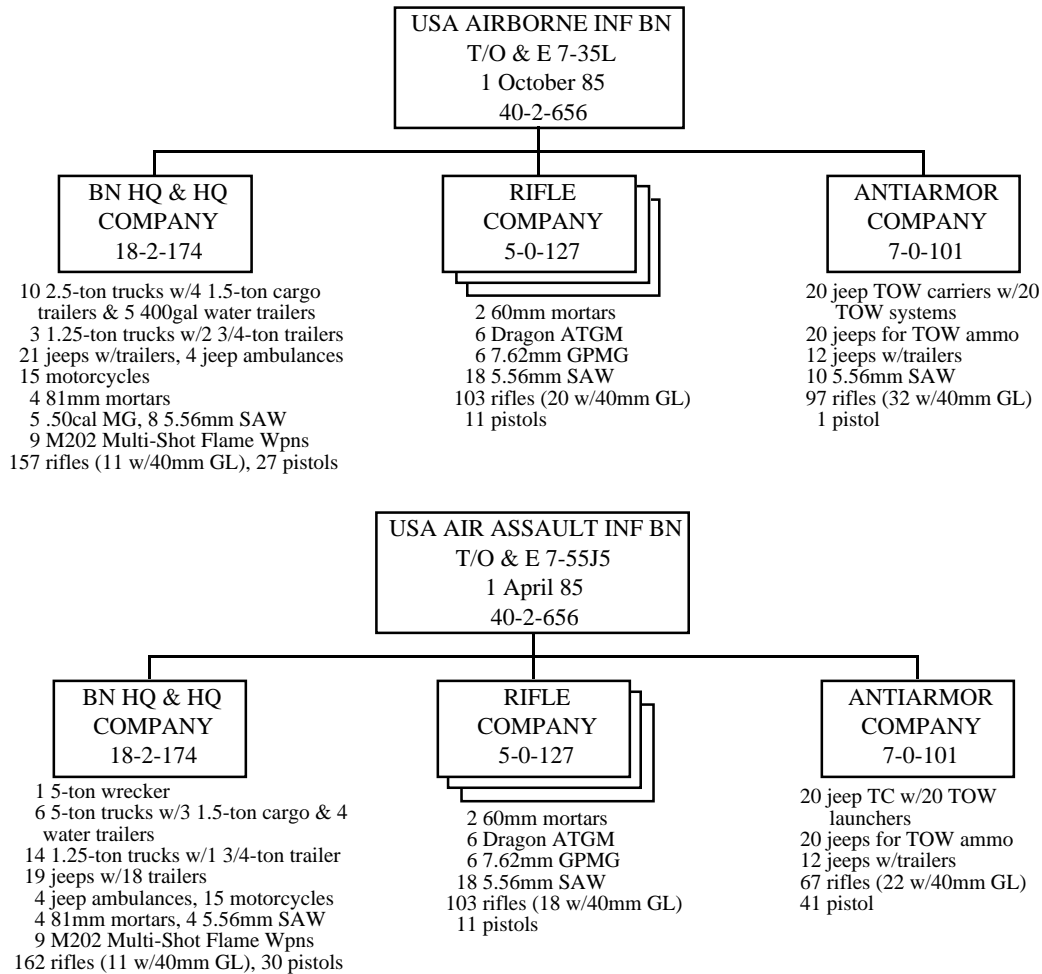

**Notes:**

Readers should note that the light infantry battalions that the Army was organizing at this time had priority for the new HMMWV trucks and that the airborne and air assault battalions would continue to use the existing M151 series jeeps and M561 "Gamma Goats" for several years longer (as the tables above indicate). In addition the Rangers and light infantry would also have priority for the new M249 squad automatic weapon (SAW) and although the airborne and air assault battalions would carry the SAW on their equipment tables the actual delivery of these weapons was delayed by a year or two. An M16 rifle with a bipod was the substitute for the SAW.

Sources: Department of the Army Tables of Organization 7-35L "Infantry Battalion, (Airborne) (AOE)" (Washington DC 1 October 1985) and 7-55J5 "Infantry Battalion (Air Assault) (AOE)" (Washington DC 1 April 1985)

Appendix 12.7

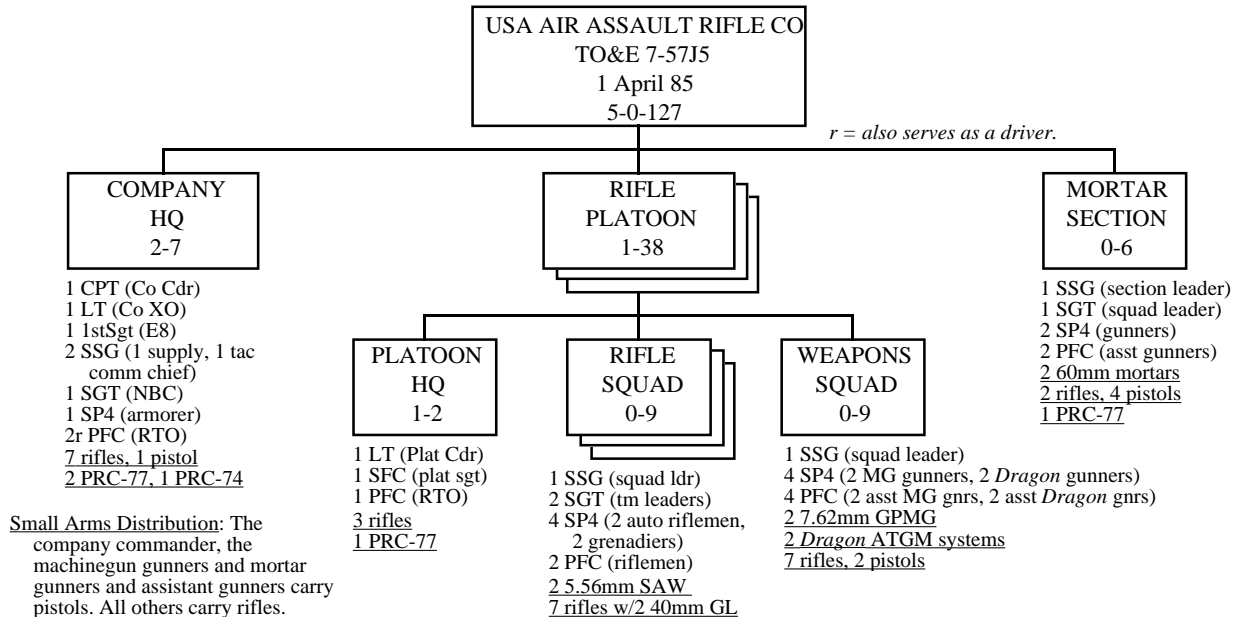
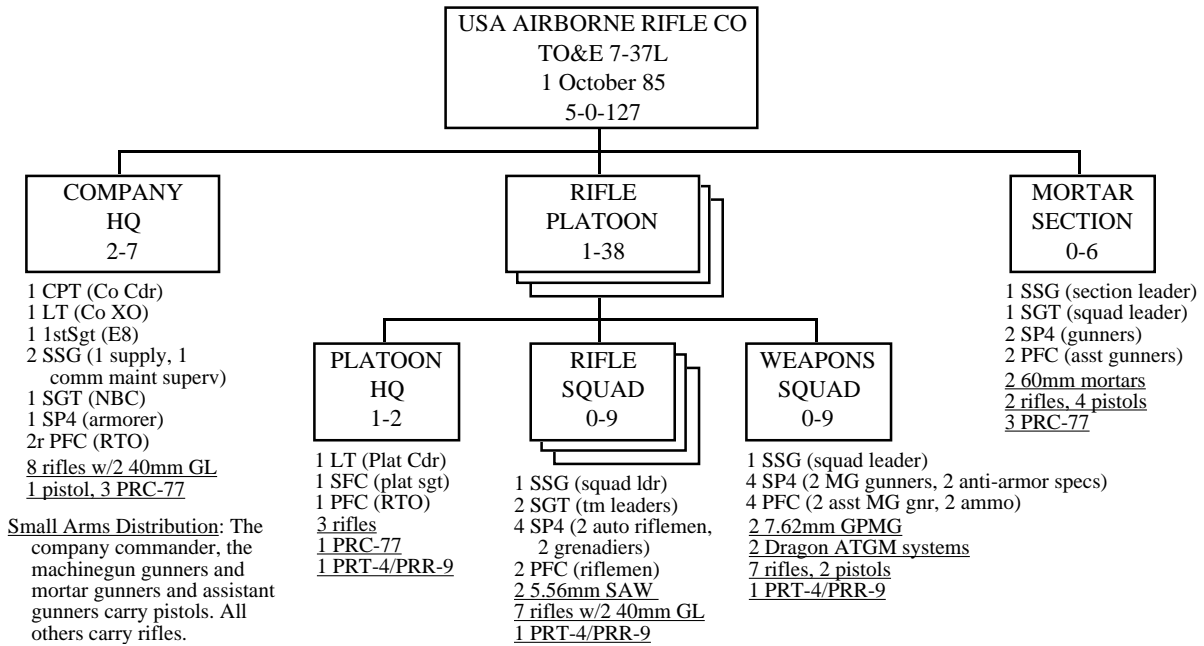

Notes:

**Sources:** Department of the Army Tables of Organization 7-37L “Rifle Company, Infantry Battalion, (Airborne) (AOE)” (Washington DC 1 October 1985) and 7-57J5 “Rifle Company, Infantry Battalion (Air Assault) (AOE)” (Washington DC 1 April 1985)

Appendix 12.8

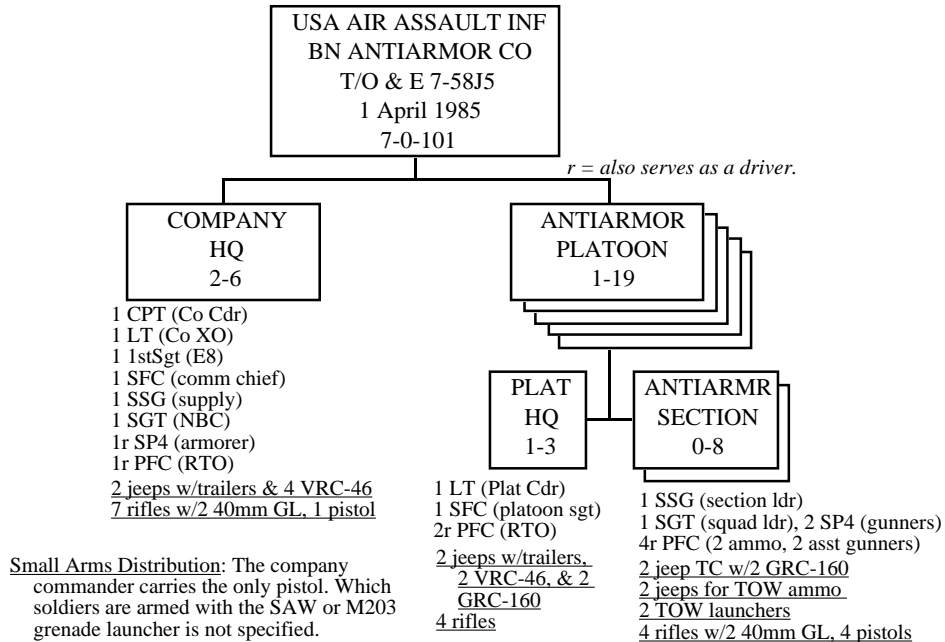
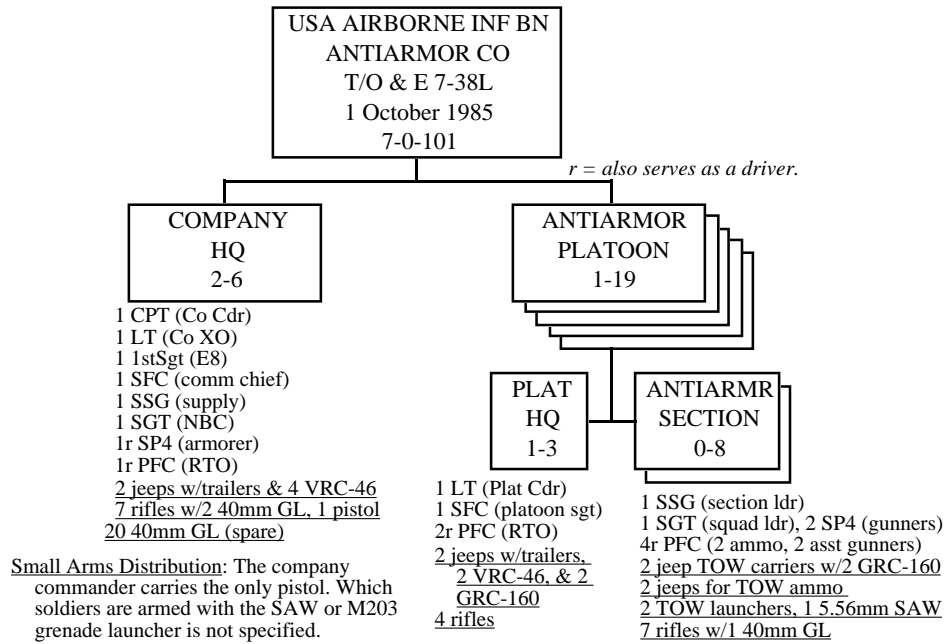

Notes:

**Source:** Department of the Army Tables of Organization 7-38L “Anti-Armor Company, Infantry Battalion, (Airborne) (AOE)” (Washington DC 1 October 1985) and 7-58J5 “Anti-Armor Company, Infantry Battalion (Air Assault)” (Washington DC 1 April 1985) (AOE)



Appendix 12.9

USA AIRBORNE INF BN  
 HQ & HQ COMPANY  
 TO & E 7-36L  
 1 October 85  
 18-2-174

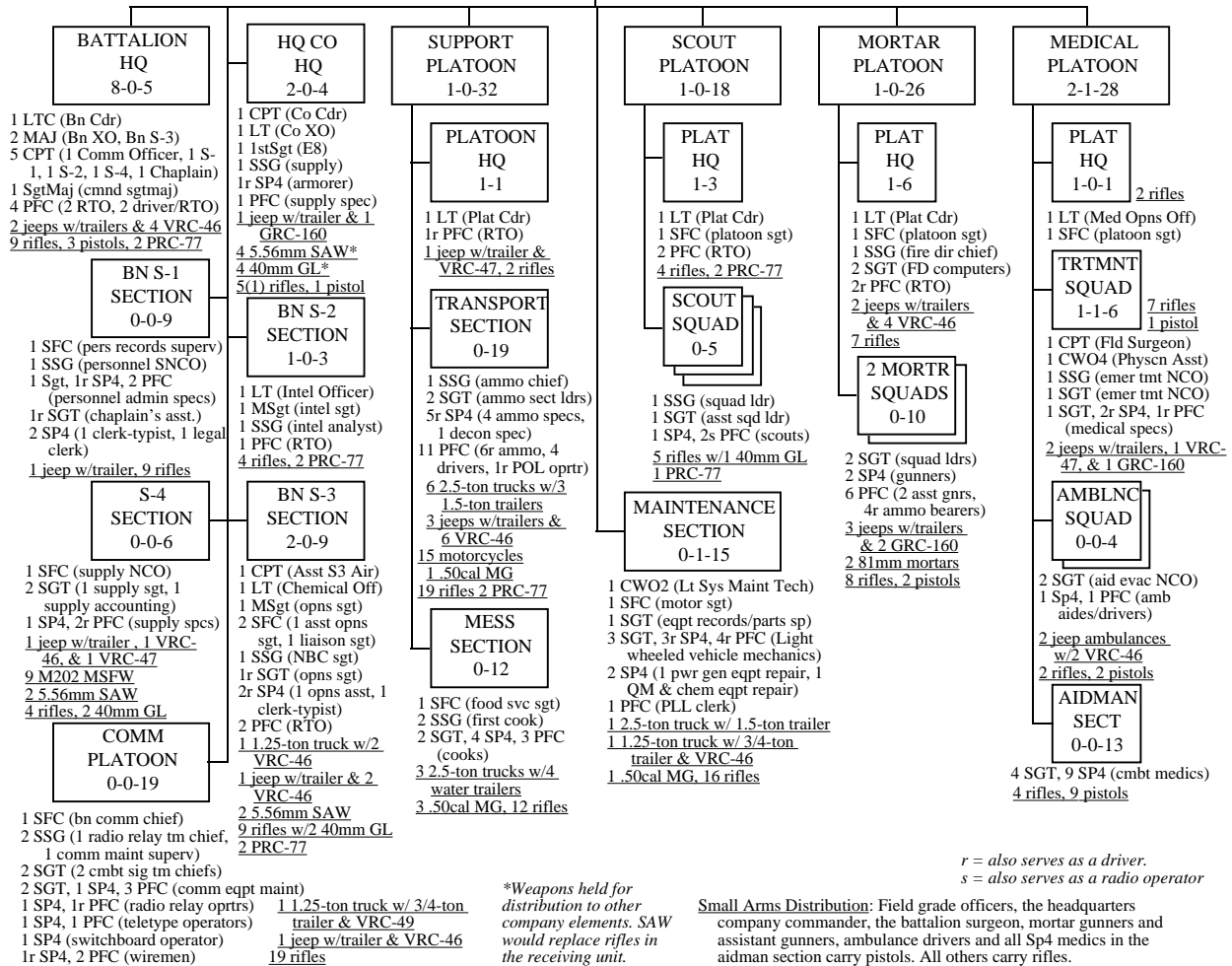

Continued next page

Appendix 12.9 (continued)

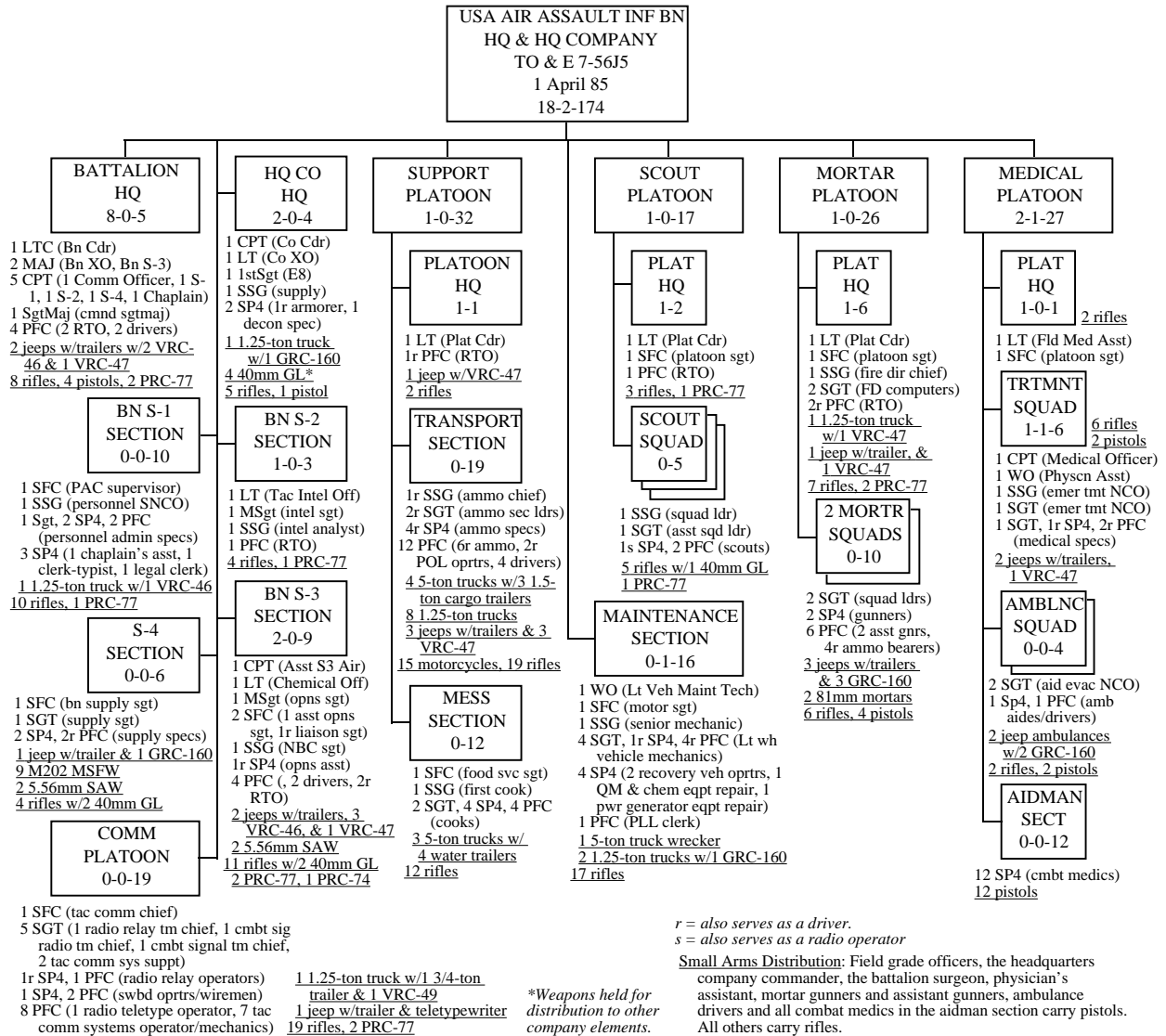

Notes:

**Sources:** Department of the Army Tables of Organization 7-36L "Headquarters and Headquarters Company, Infantry Battalion, (Airborne) (AOE)" (Washington DC 1 October 1985) and 7-56J5 "Headquarters and Headquarters Company, Infantry Battalion (Air Assault) (AOE)" (Washington DC 1 April 1985)

**Appendix 12.10**

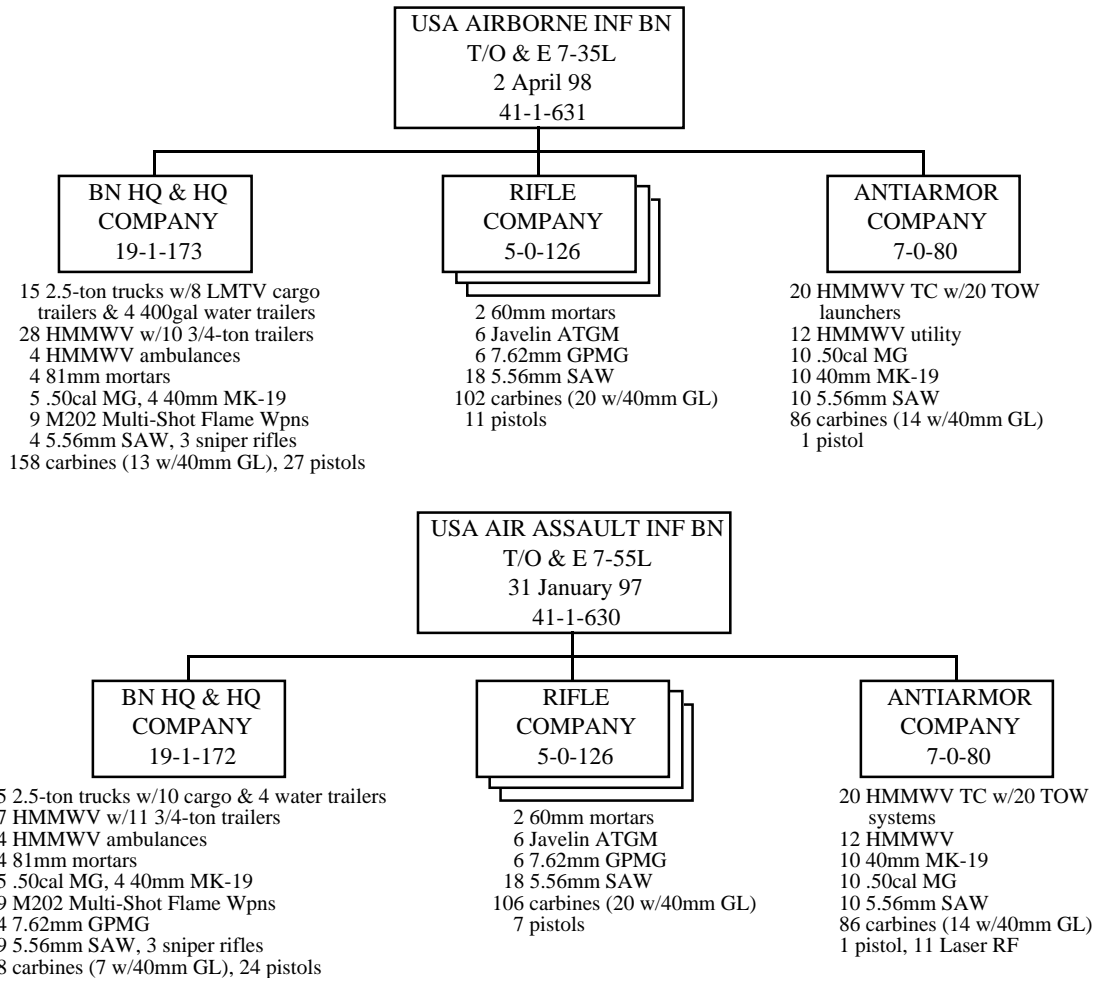

Notes:

Sources: Department of the Army Tables of Organization 7-35L "Infantry Battalion, (Airborne)" (Washington DC 2 April 1998) and 7-55L "Infantry Battalion (Air Assault)" (Washington DC 31 January 1997)

Appendix 12.11

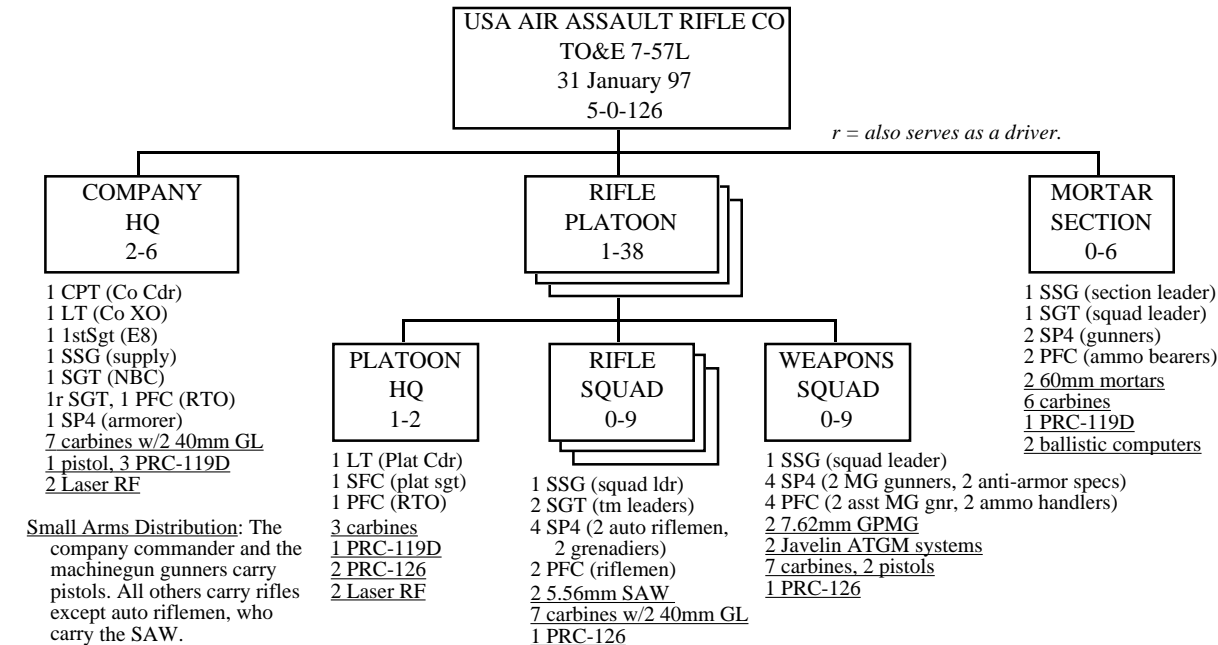
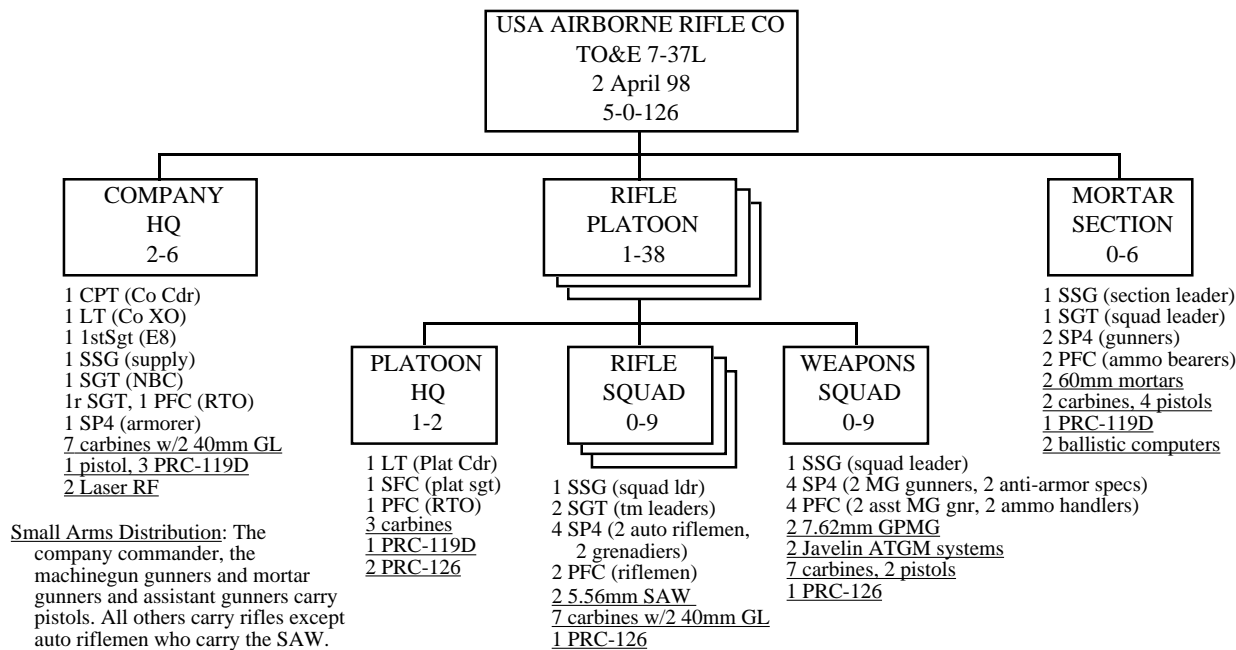

Notes:

Sources: Department of the Army Tables of Organization 7-37L "Rifle Company, Infantry Battalion, (Airborne)" (Washington DC 2 April 1998) and 7-57L "Rifle Company, Infantry Battalion (Air Assault)" (Washington DC 31 January 1997)

Appendix 12.12

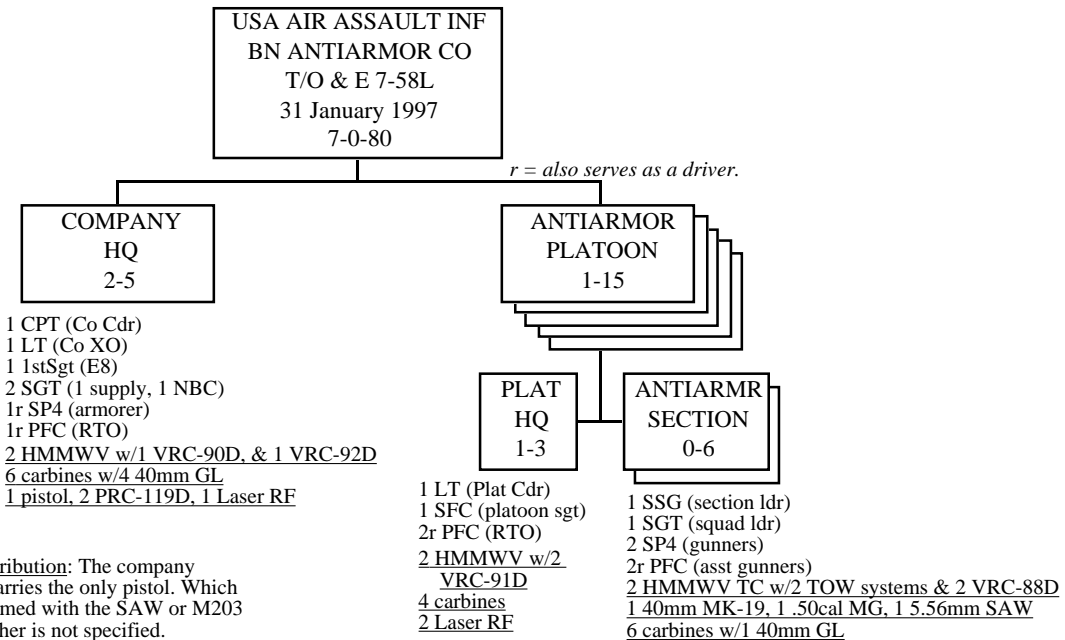
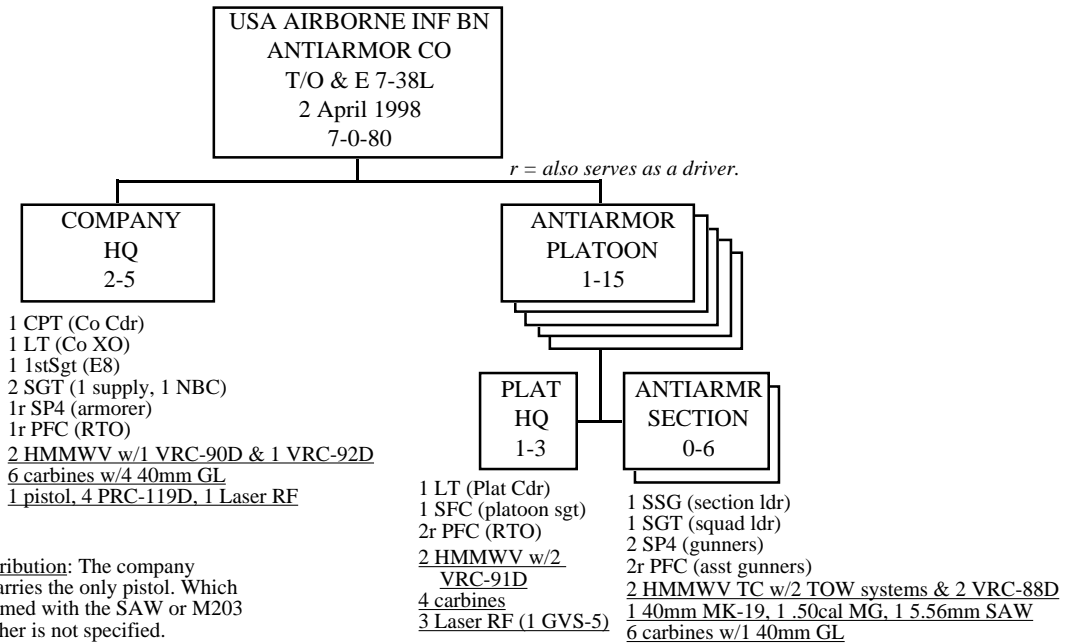

Notes:

Source: Department of the Army Tables of Organization 7-38L "Anti-Armor Company, Infantry Battalion, (Airborne)" (Washington DC 2 April 1998) and 7-58L "Anti-Armor Company, Infantry Battalion (Air Assault)" (Washington DC 31 January 1997)

Appendix 12.13

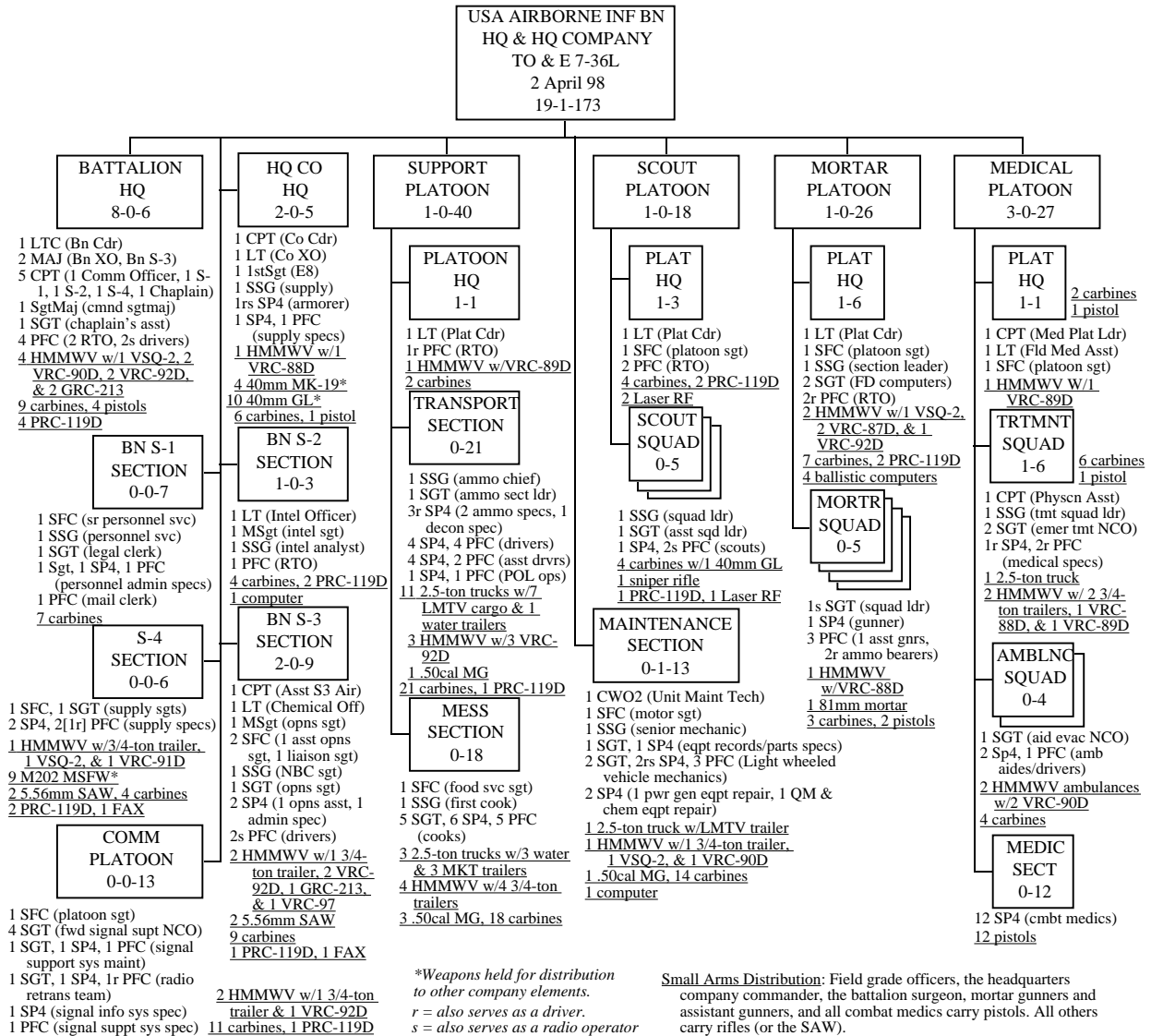

Continued next page

Appendix 12.13 (continued)

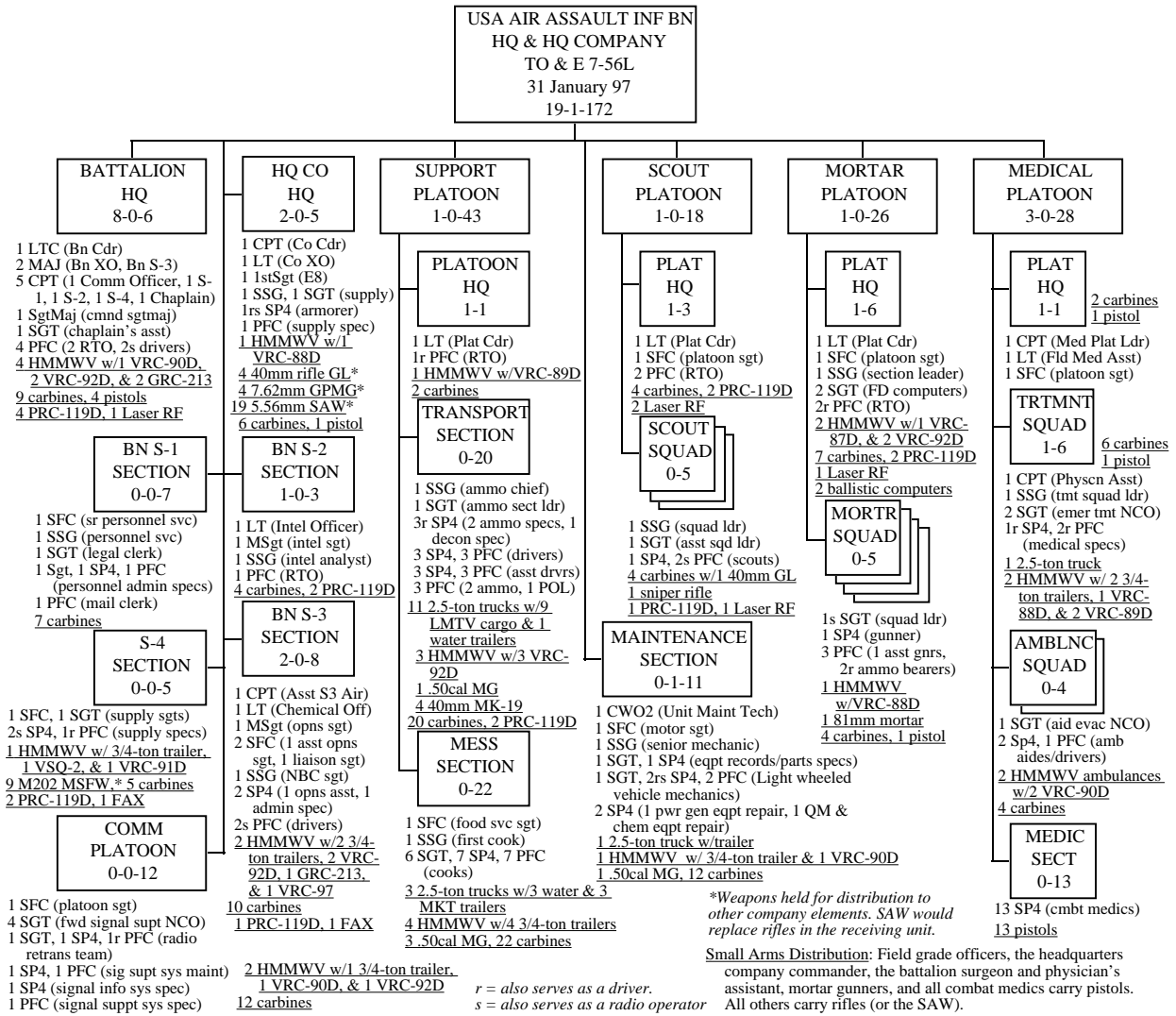

Notes:

Sources: Department of the Army Tables of Organization 7-36L "Headquarters and Headquarters Company, Infantry Battalion, (Airborne)" (Washington DC 2 April 1998) and 7-56L "Headquarters and Headquarters Company, Infantry Battalion (Air Assault)" (Washington DC 31 January 1997)

**Appendix 12.14**

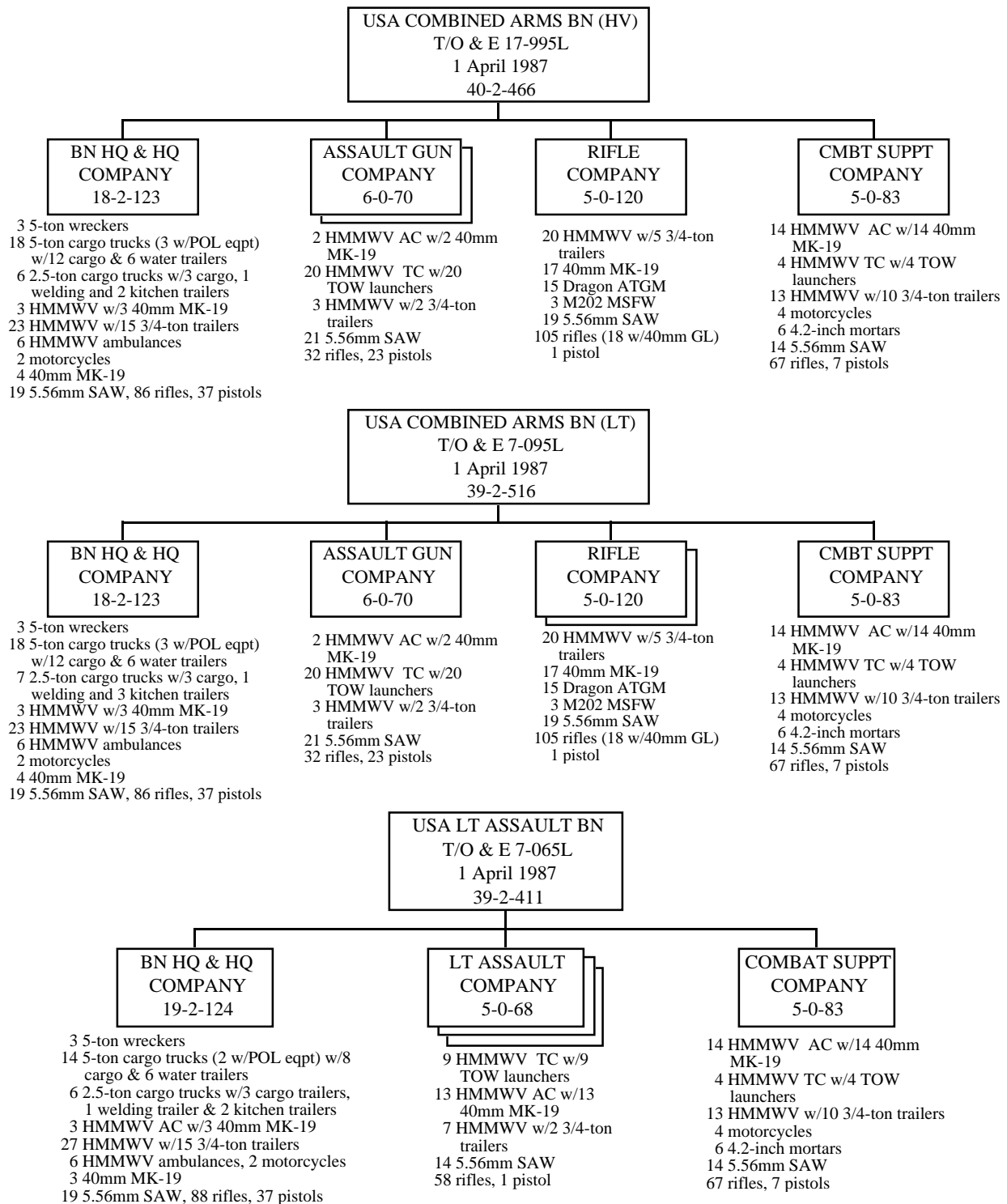

Notes:

Sources: Department of the Army Tables of Organization 17-995L "Combined Arms Battalion (Heavy), Infantry Division (Motorized) (AOE);" 7-095L "Combined Arms Battalion (Light), Infantry Division (Motorized) (AOE)" and 7-065L "Light Assault Battalion, Infantry Division (Motorized) (AOE)" (all Washington DC, 1 April 1987)



Appendix 12.15

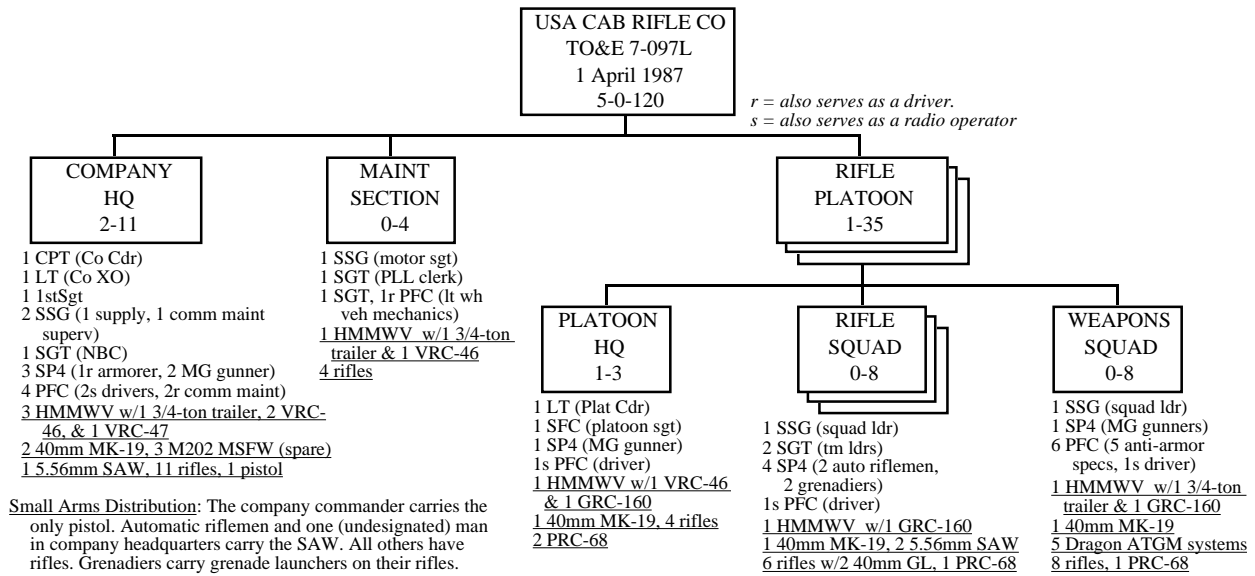
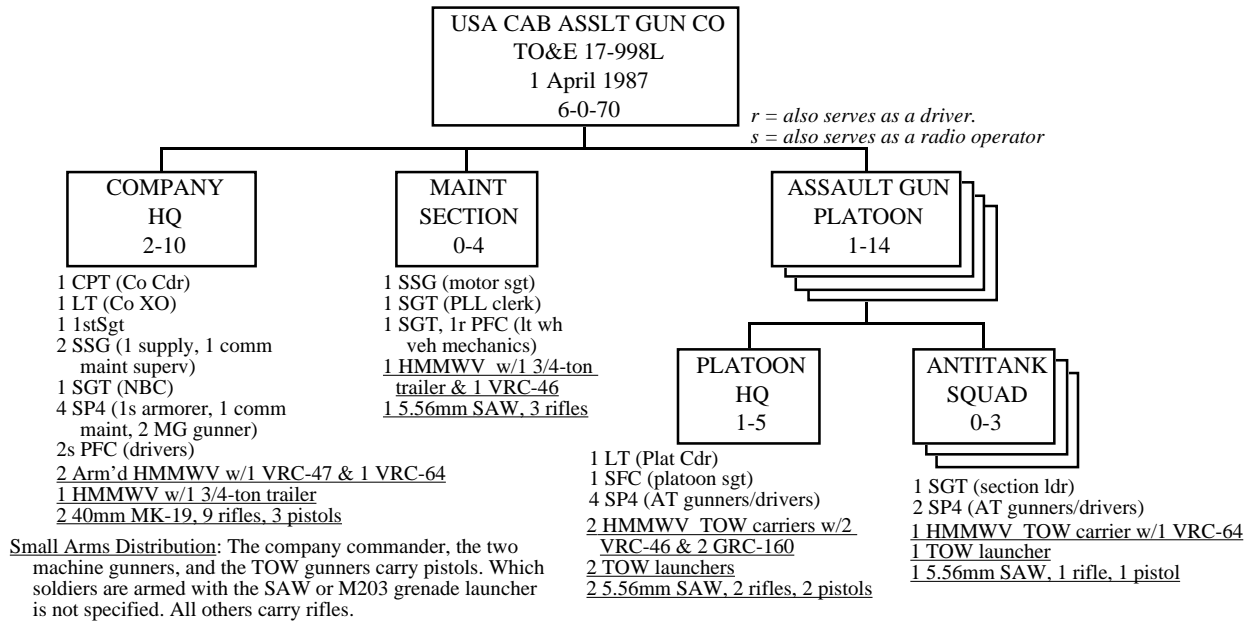

Notes:

**Sources:** Department of the Army Tables of Organization 17-998L "Assault Gun Company, Combined Arms Battalion, Infantry Division (Motorized) (AOE)" and 7-097L "Rifle Company, Combined Arms Battalion, Infantry Division (Motorized) (AOE)" (both Washington DC, 1 April 1987)

Appendix 12.16

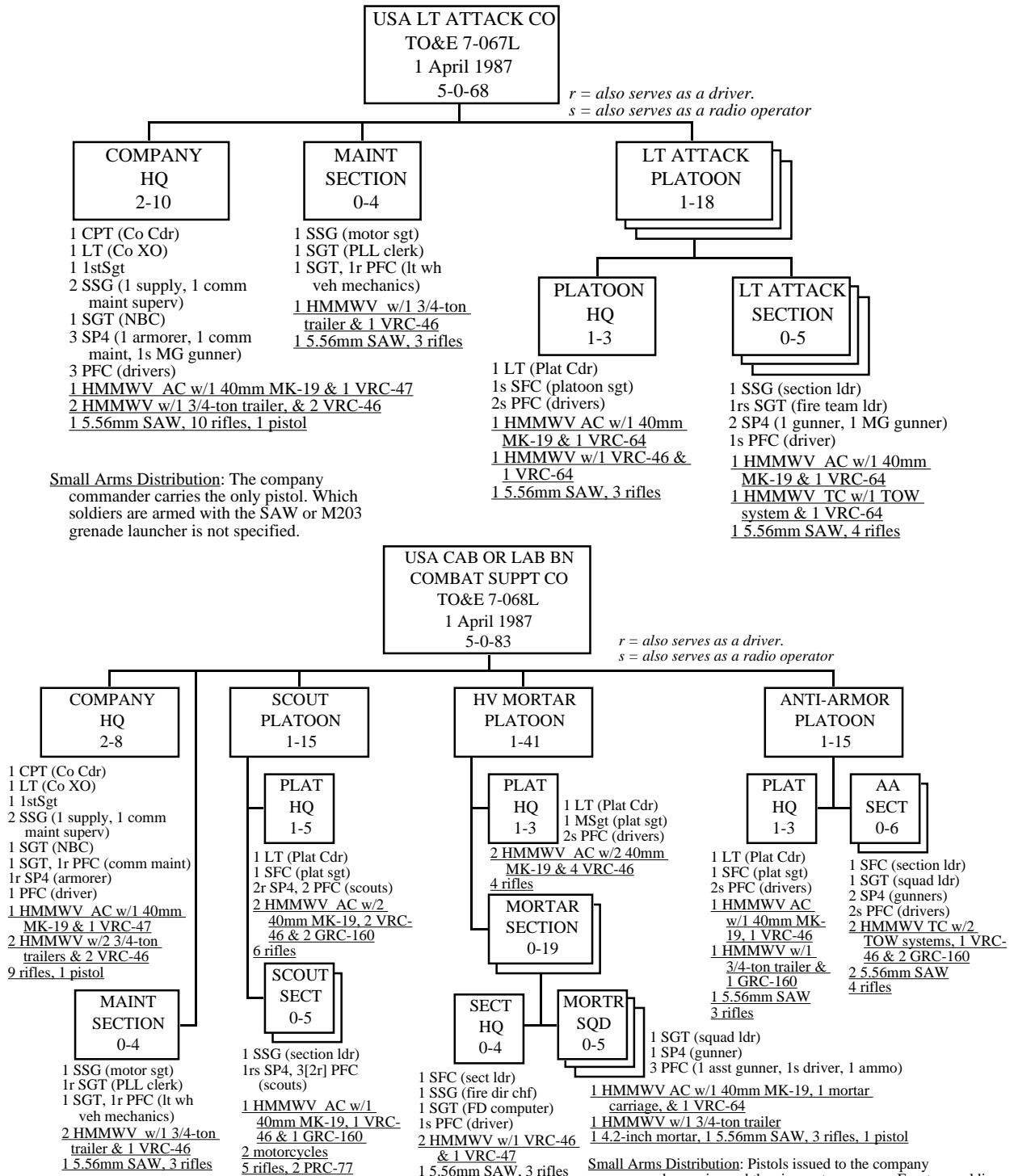

Notes:

**Sources:** Department of the Army Tables of Organization 7-067L "Light Attack Company, Light Attack Battalion, Infantry Division (Motorized) (AOE)" and 7-068L "Combat Support Company. Combined Arms Battalion or Light Attack Battalion, Infantry Division (Motorized) (AOE)" (both Washington DC, 1 April 1987)

**Appendix 12.17**

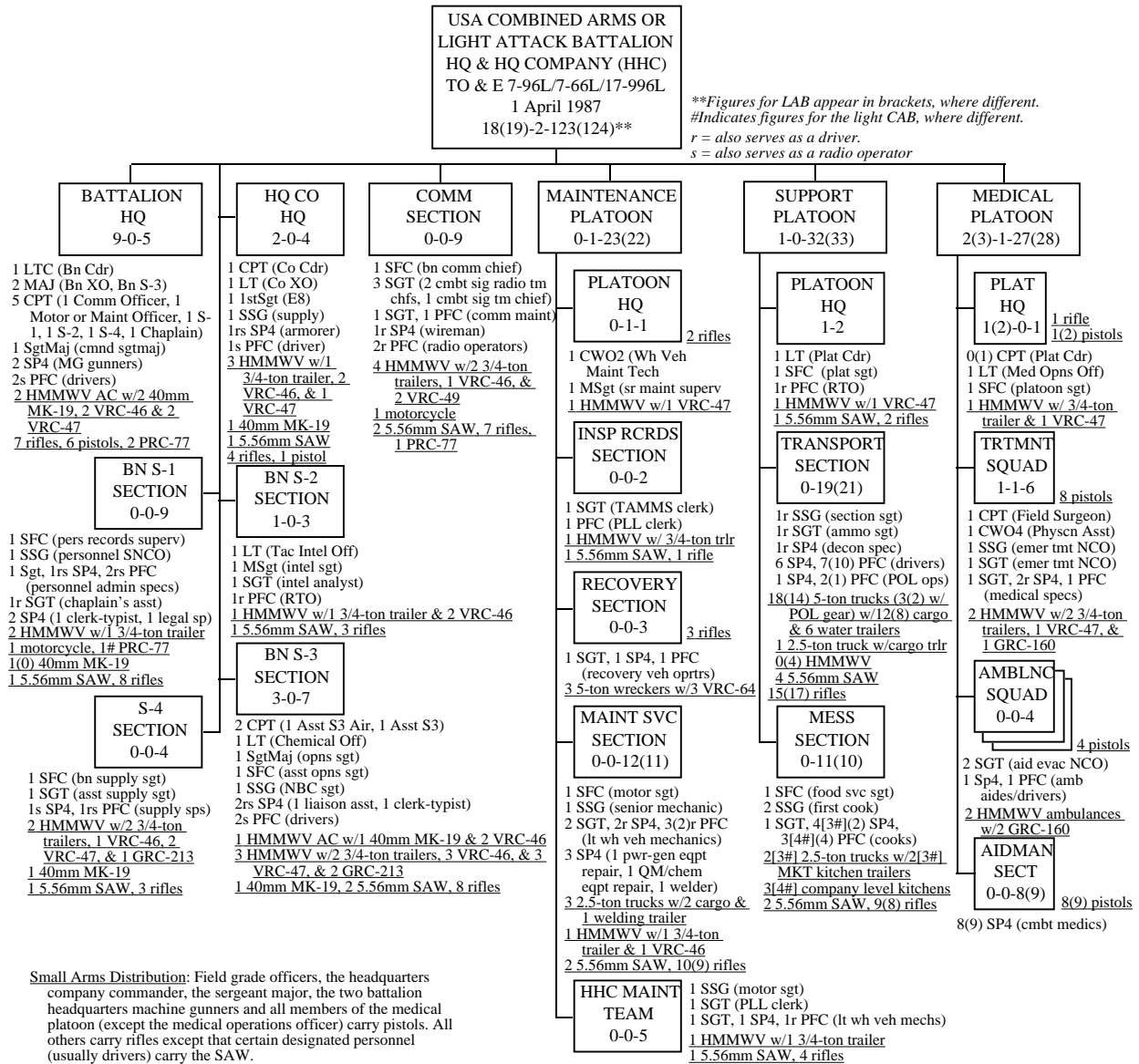

**Notes:**

**Sources:** Department of the Army Tables of Organization 7-066L "Headquarters and Headquarters Company, Light Attack Battalion, Infantry Division (Motorized) (AOE);" 17-996L "Headquarters and Headquarters Company, Combined Arms Battalion (Heavy), Infantry Division (Motorized) (AOE)" and 7-096L "Headquarters and Headquarters Company, Combined Arms Battalion (Light), Infantry Division (Motorized) (AOE)" (all Washington DC, 1 April 1987)

Appendix 12.18

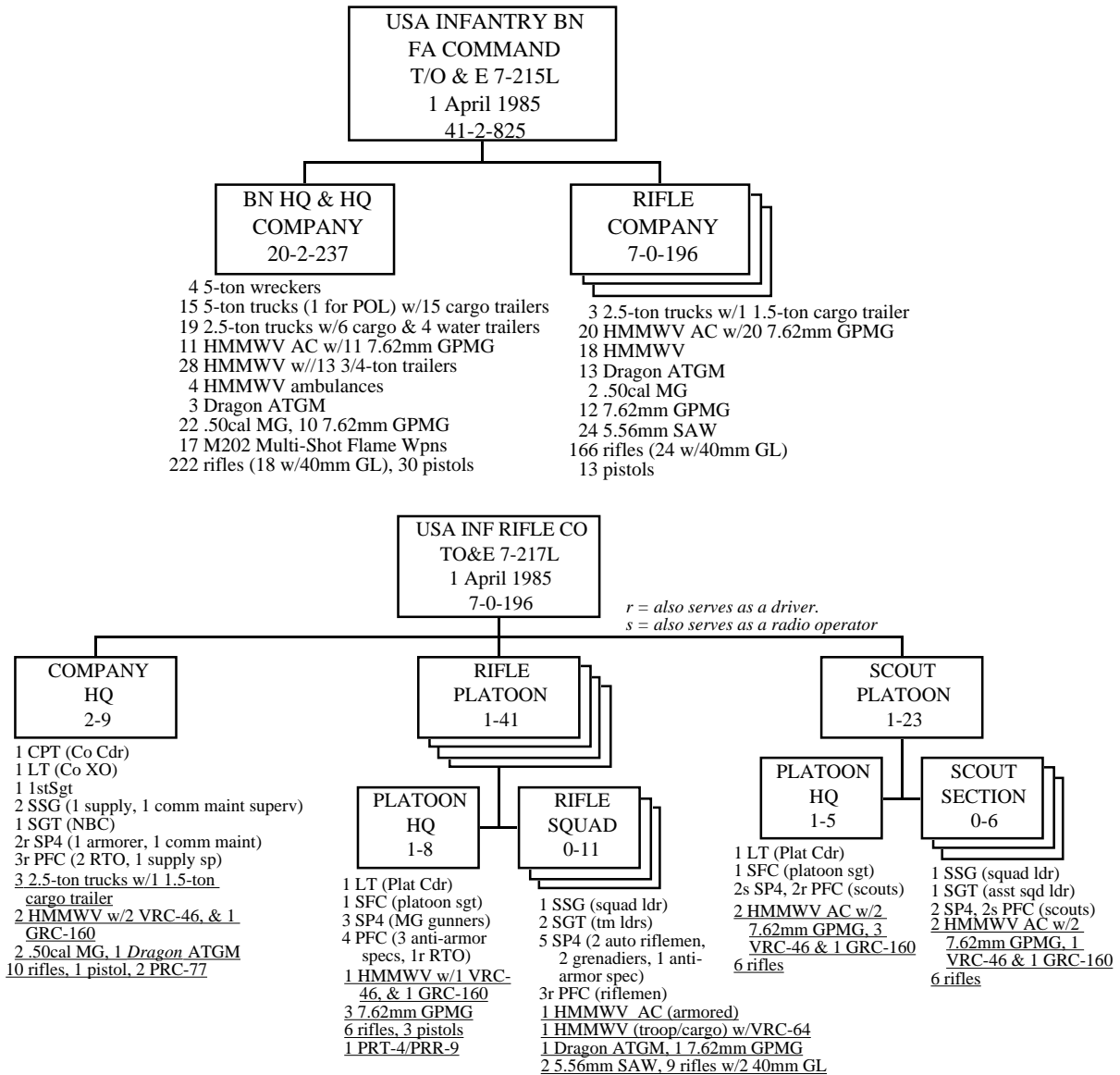

Small Arms Distribution: The company commander and the machine gunners in each rifle platoon headquarters carry pistols. Automatic riflemen carry the SAW. All others have rifles. Grenadiers carry grenade launchers on their rifles.

Notes:

Company headquarters: The armorer, the communication maintenance man and the supply specialist drive the three 2.5-ton trucks. The two RTO drive the two HMMWV. The *Dragon* system in company headquarters was extra equipment for the company commander to issue as needed.

Rifle Platoons: Each platoon headquarters included three machine gunners with 7.62mm machineguns (M60) and three anti-armor specialists with Dragons. One of each of these men would ride with the three rifle squads. This gave each squad a second machinegun to mount in its armored HMMWV armament carrier or to carry in its unarmored HMMWV troop/cargo carrier.

Sources: Department of the Army Tables of Organization 7-215L "Infantry Battalion, Field Artillery Command (Pershing) (AOE)" and 7-217L "Rifle Company, Infantry Battalion, Field Artillery Command (Pershing) (AOE)" (both Washington DC 1 April 1985)

## Appendix 12.19

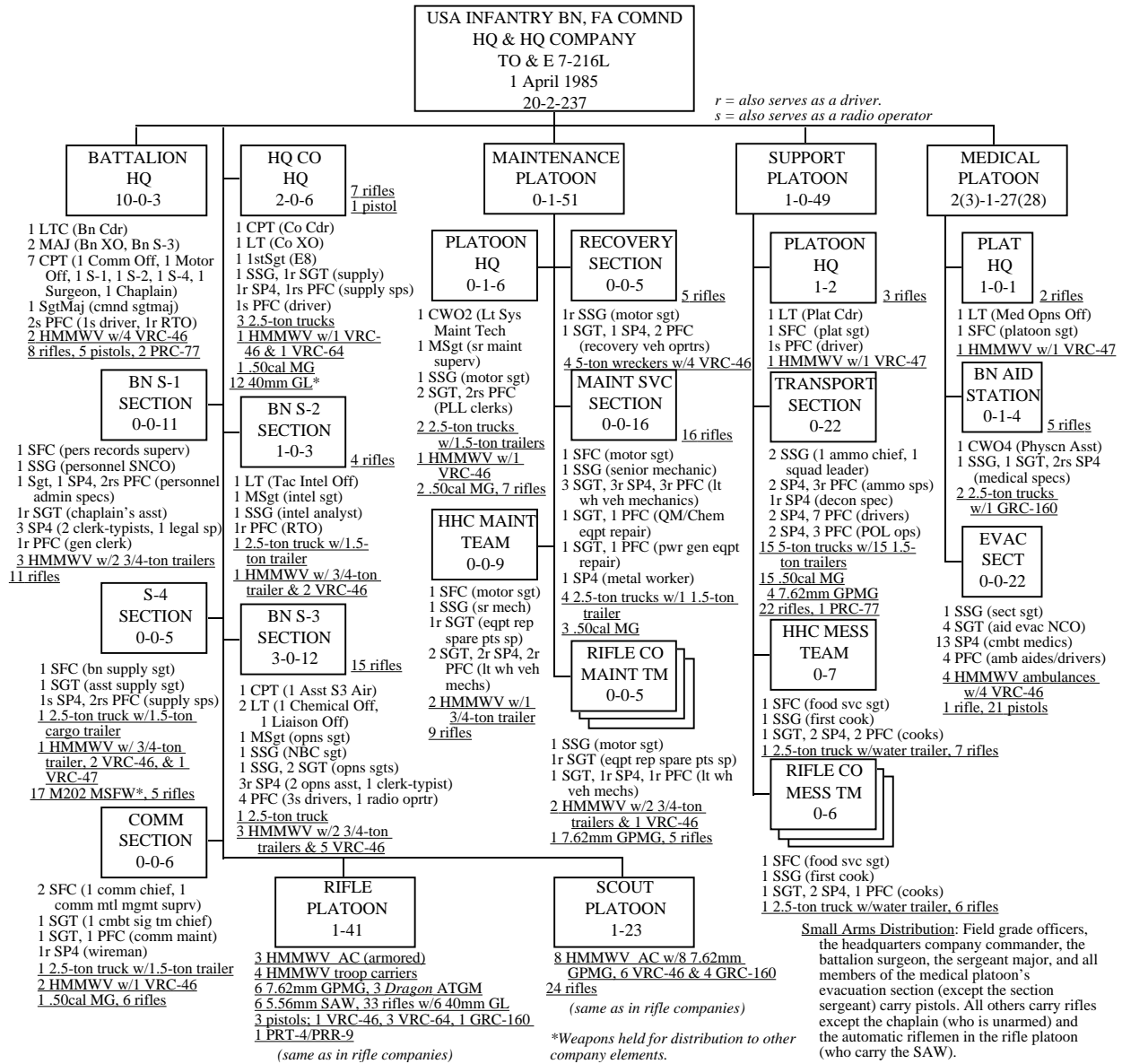

**Notes:**

**Source:** Department of the Army Table of Organization 7-216L "Headquarters and Headquarters Company, Infantry Battalion, Field Artillery Command (Pershing) (AOE)" (Washington DC 1 April 1985)

**Appendix 12.20**

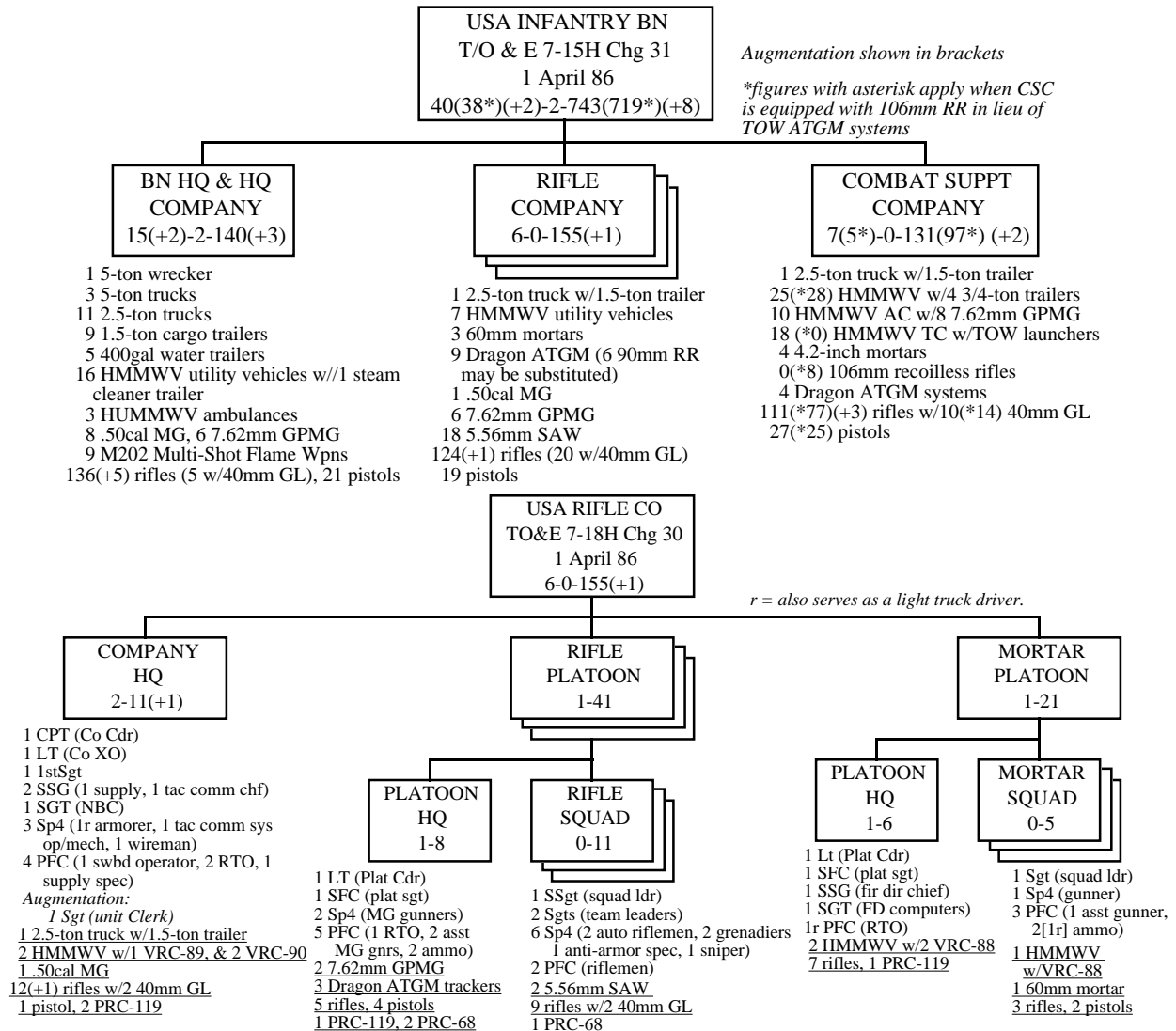

**Small Arms Distribution:** Pistols issued the company commander and all machinegun and mortar gunners and assistant gunners. Automatic riflemen carry the SAW. All other personnel carry rifles but, apart from the grenadiers in the rifle squads, the tables do not specify which ones (apart from the rifle grenadiers) carry M203 40mm grenade launchers on their weapons.

**Notes:**

**New Equipment:** Few if any of these battalions received the HMMWV trucks or the SINCGARS radios that the Army officially prescribed for them and that appear in the above diagrams. Battalions without the more modern equipment would substitute M151 series jeeps with trailers for most HMMWV (on a “one for one” basis). M561 “Gamma Goats” would substitute for the remaining HMMWV (mainly those in the mortar platoon). AN/VRC-12 series radios (including AN/VRC-46, -47 and -49) would substitute for the AN/VRC-89, -90, -91 and -92; the AN/PRC-77 would substitute for the AN/PRC-119 and the AN/GRC-160 for the AN/VRC-88. AN/PRC-68 radios would be available. Apart from the new equipment (non-existent as most of it would be for several more years) the organizations shown above had not changed significantly since 1981.

**Mortars:** Many battalions had not received the M224 60mm mortars by this date and were still using the M29 81mm mortars.

**Sources:** Department of the Army Tables of Organization 7-15H with Change 31 “Infantry Battalion, Infantry Division” and 7-18H with Change 30 “Rifle Company, Infantry Battalion, Infantry Division (both Washington DC and originally published 18 November 1970; Changes 30 and 31 appeared in April 1986).

Appendix 12.21

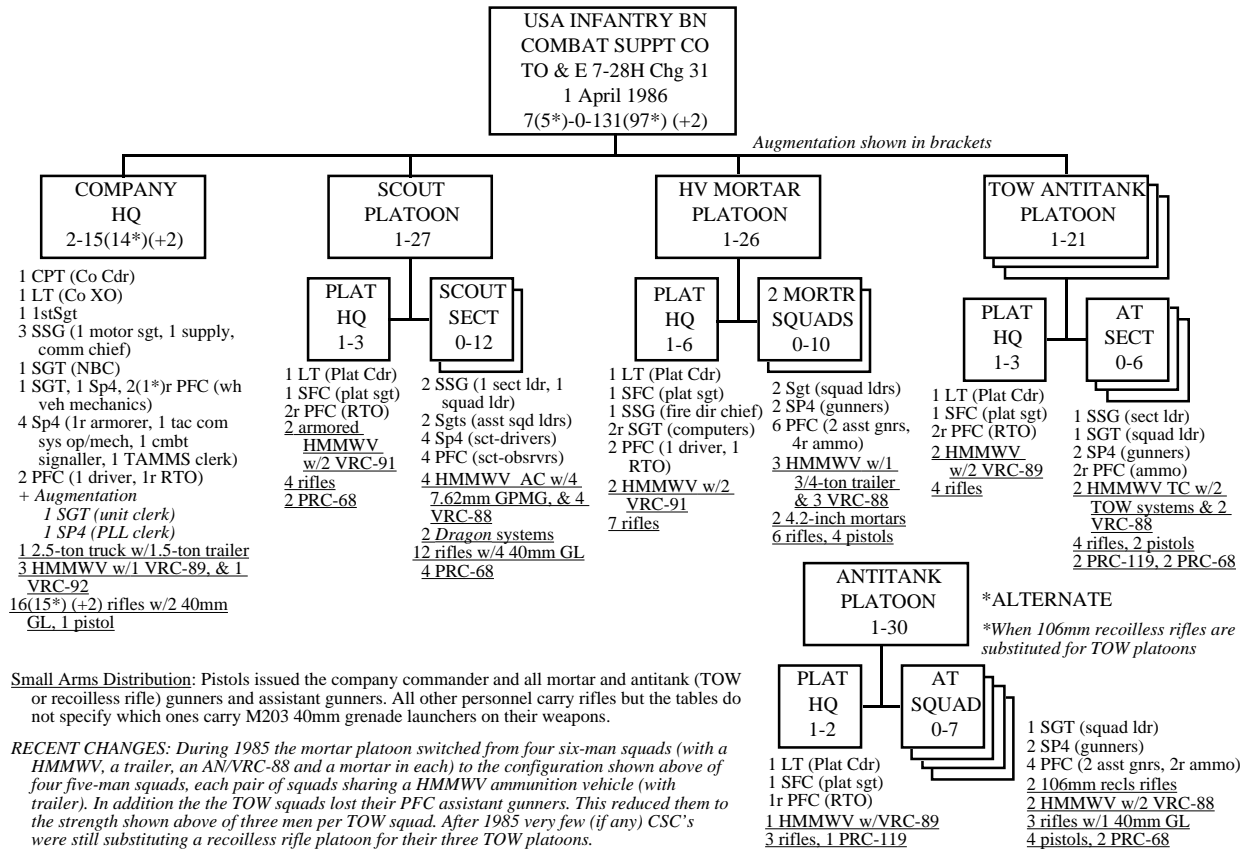

**Small Arms Distribution:** Pistols issued the company commander and all mortar and antitank (TOW or recoilless rifle) gunners and assistant gunners. All other personnel carry rifles but the tables do not specify which ones carry M203 40mm grenade launchers on their weapons.

**RECENT CHANGES:** During 1985 the mortar platoon switched from four six-man squads (with a HMMWV, a trailer, an AN/VRC-88 and a mortar in each) to the configuration shown above of four five-man squads, each pair of squads sharing a HMMWV ammunition vehicle (with trailer). In addition the the TOW squads lost their PFC assistant gunners. This reduced them to the strength shown above of three men per TOW squad. After 1985 very few (if any) CSC's were still substituting a recoilless rifle platoon for their three TOW platoons.

**Notes:** In battalions that were still using the 106mm recoilless rifles, the one antitank platoon shown replaces all three of the TOW platoons. The notes for Appendix 12.20 also apply here.

**Source:** Department of the Army Tables of Organization 7-28H with Change 31 "Combat Support Company, Infantry Battalion, Infantry Division" (Washington DC; originally published 18 November 1970; Change 31 appeared in April 1986).

Appendix 12.22

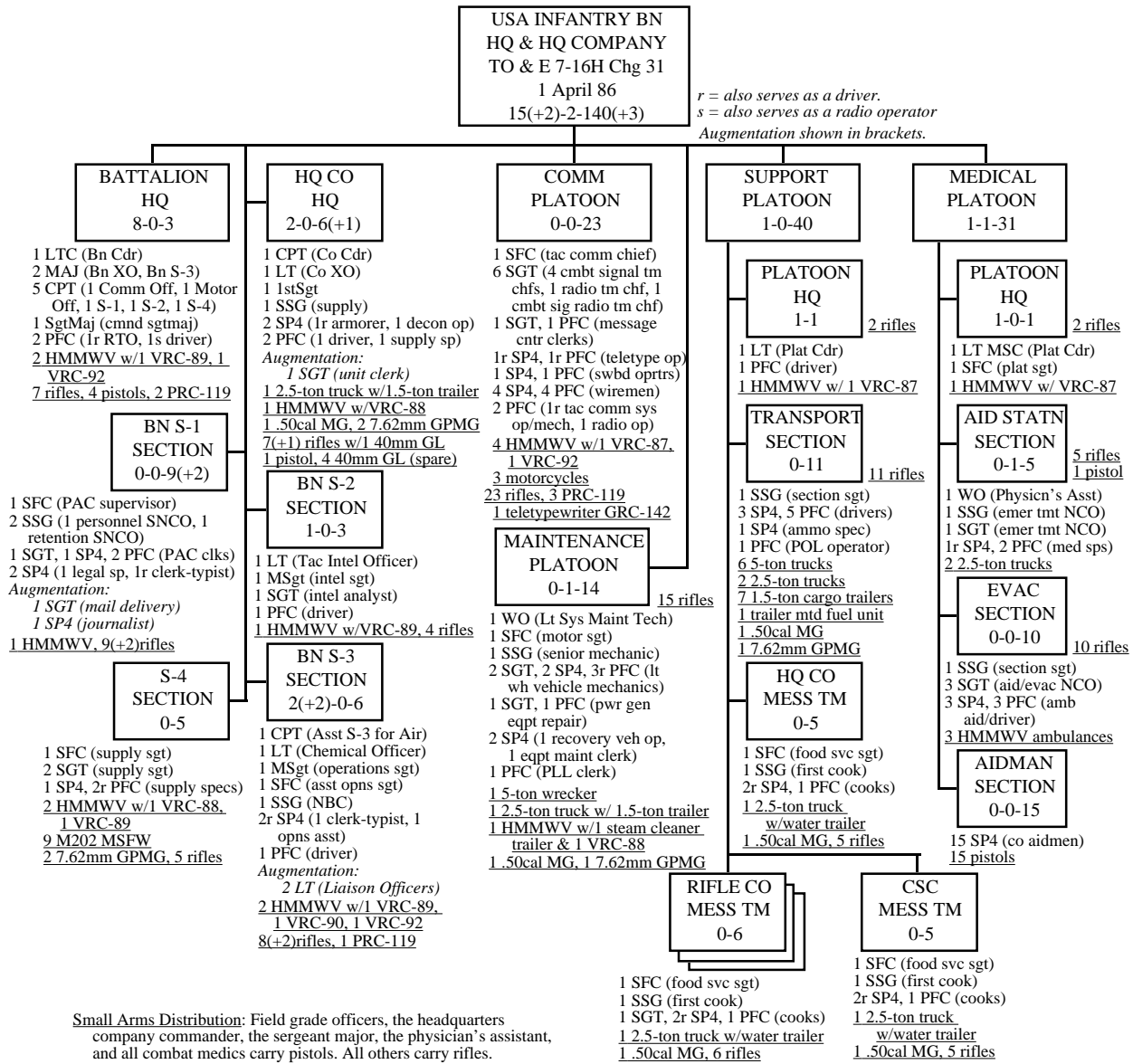

Notes: The notes for Appendix 12.20 also apply here.

Source: Department of the Army Tables of Organization 7-16H with Change 31 "Headquarters and Headquarters Company, Infantry Battalion, Infantry Division" (Washington DC; originally published 18 November 1970; Change 31 appeared in April 1986).



Appendix 12.23

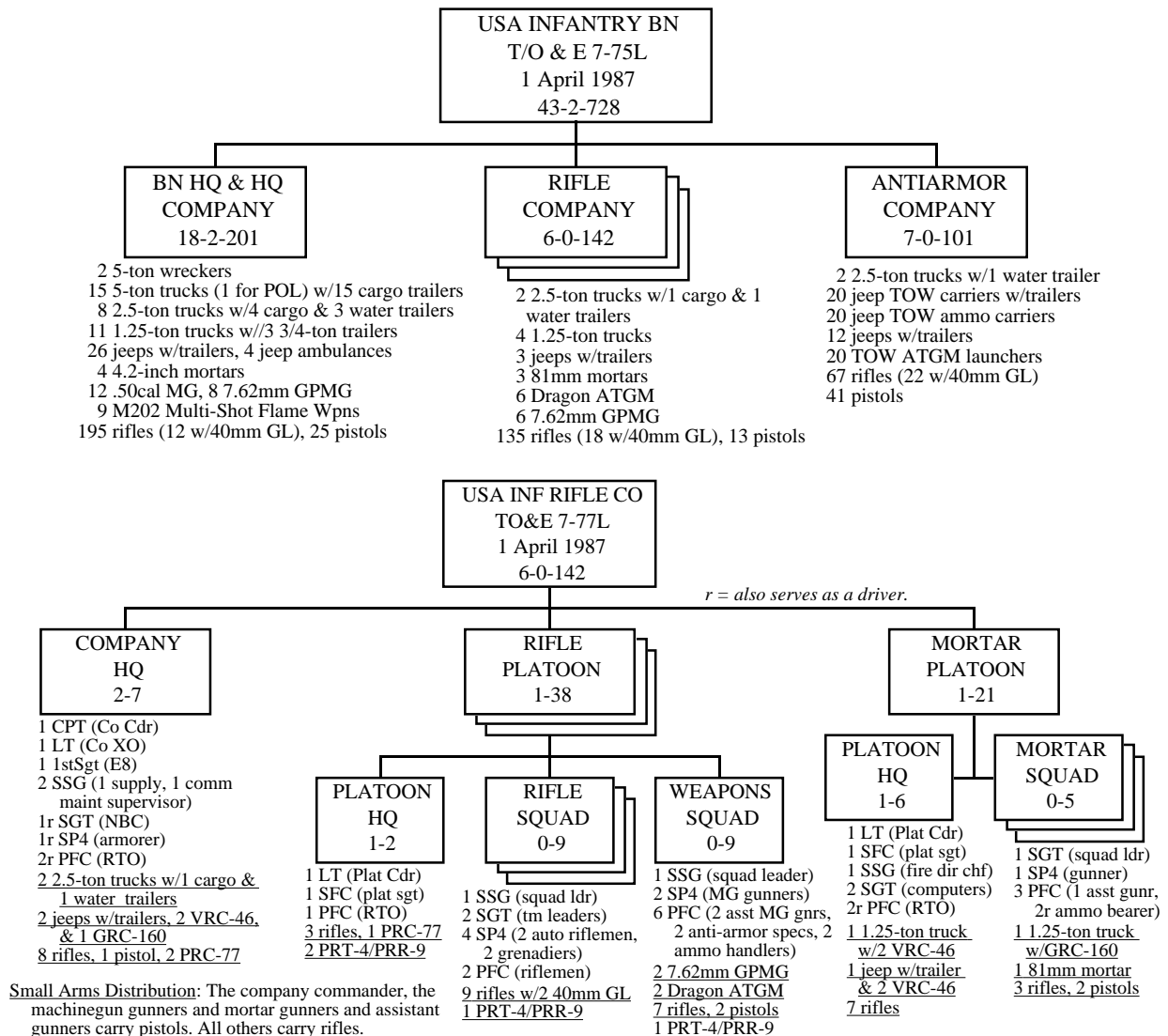

Notes: These tables were more reflective of reality in terms of equipment than the later H-Series.

Sources: Department of the Army Tables of Organization 7-75L "Infantry Battalion, Infantry Division or Separate Infantry Brigade or Theater Defense Brigade" and 7-77L "Rifle Company, Infantry Battalion, Infantry Division or Separate Infantry Brigade or Theater Defense Brigade (AOE)" (both Washington DC 1 April 1987)

Appendix 12.24

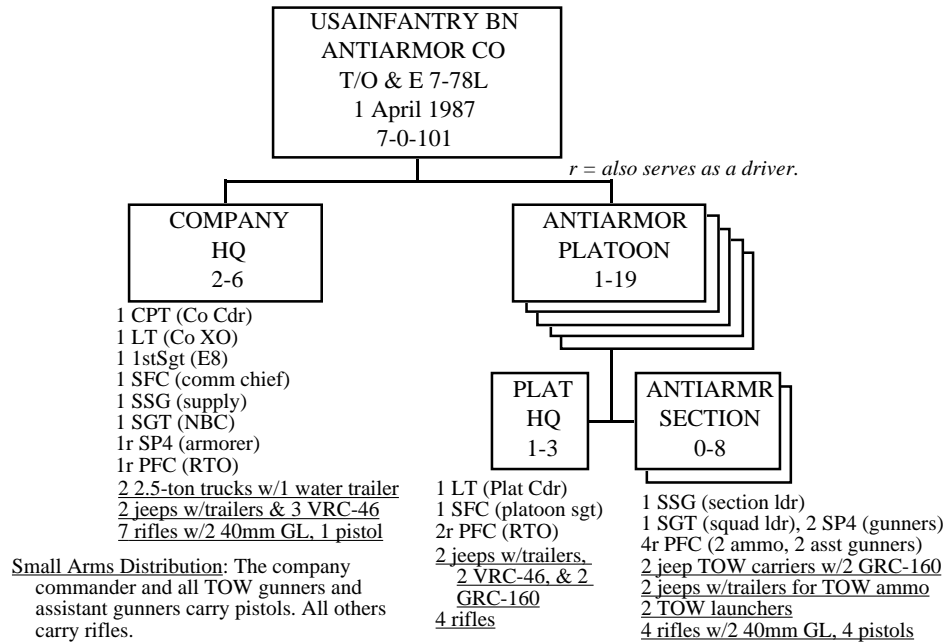

Notes:

Sources: Department of the Army Table of Organization 7-78L "Anti-Armor Company, Infantry Battalion, Infantry Division or Separate Infantry Brigade or Theater Defense Brigade (AOE)" (Washington DC 1 April 1987)

## Appendix 12.25

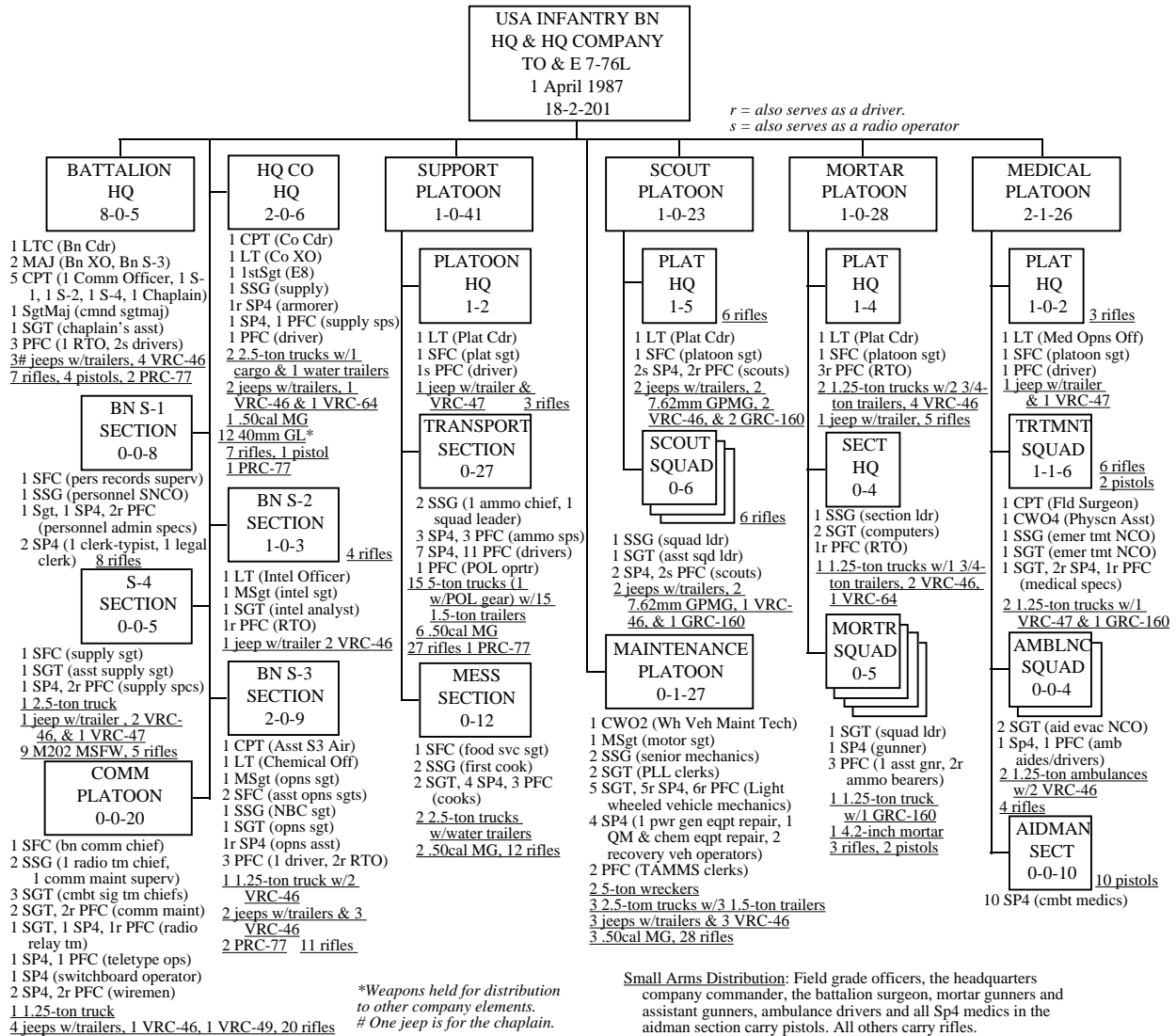

Notes:

Sources: Department of the Army Table of Organization 7-76L "Headquarters and Headquarters Company, Infantry Battalion, Infantry Division or Separate Infantry Brigade or Theater Defense Brigade (AOE)" (Washington DC 1 April 1987)

Appendix 12.26

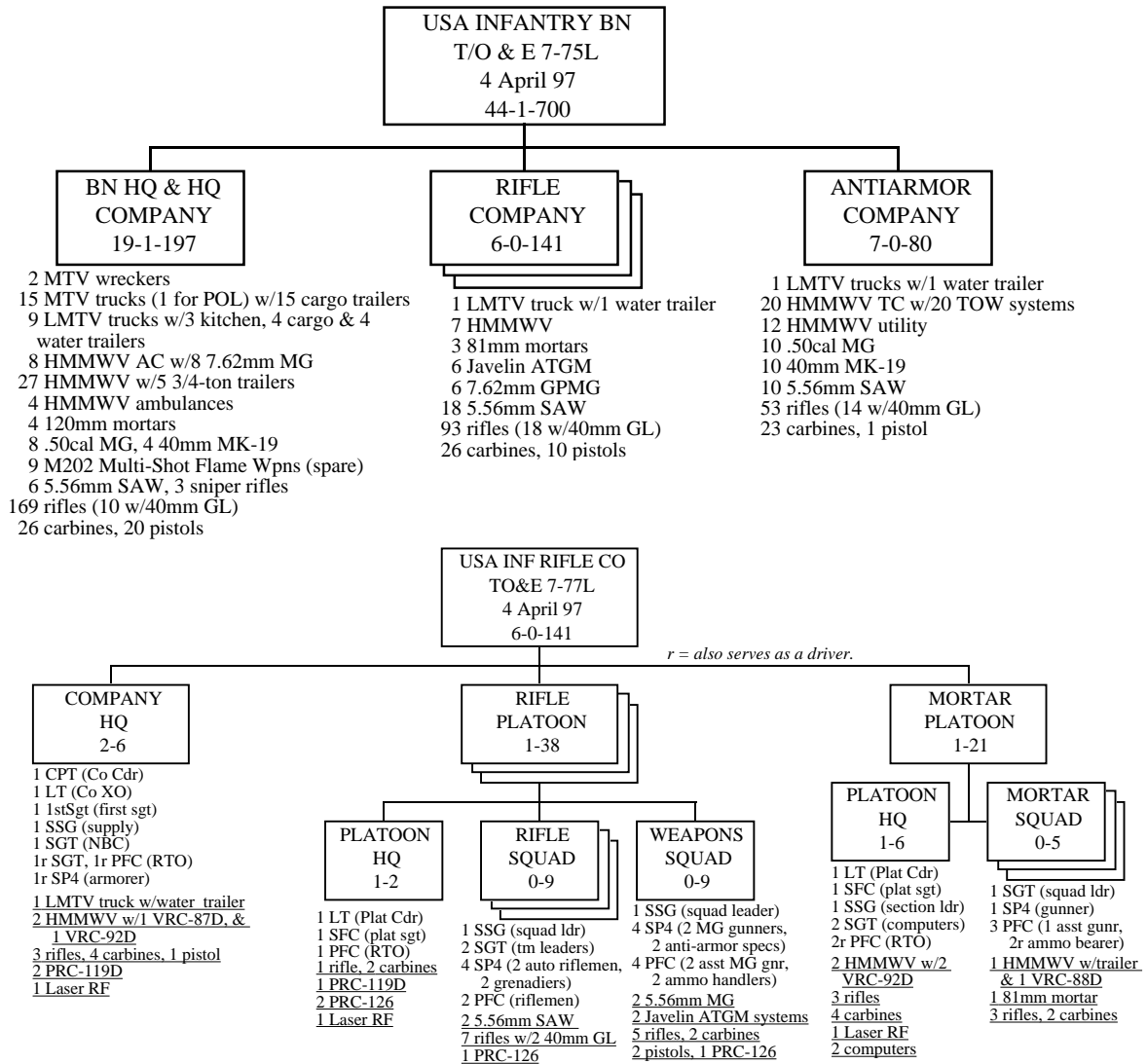

Small Arms Distribution: The company commander and the machinegun gunners carry pistols. The other officers, the first sergeant, the mortar platoon sergeant, all assistant machine gunners, mortar gunners and assistant gunners and all radio operators (RTO) carry carbines. Automatic riflemen carry the SAW. All others carry rifles.

Notes: The new equipment (HMMWV and LMTV trucks and SINCGARS radios) was actually available by this time.

Sources: Department of the Army Tables of Organization 7-75L "Infantry Battalion, Infantry Division or Separate Infantry Brigade or Theater Defense Brigade" and 7-77L "Rifle Company, Infantry Battalion, Infantry Division or Separate Infantry Brigade or Theater Defense Brigade" (both Washington DC 4 April 1997)

Appendix 12.27

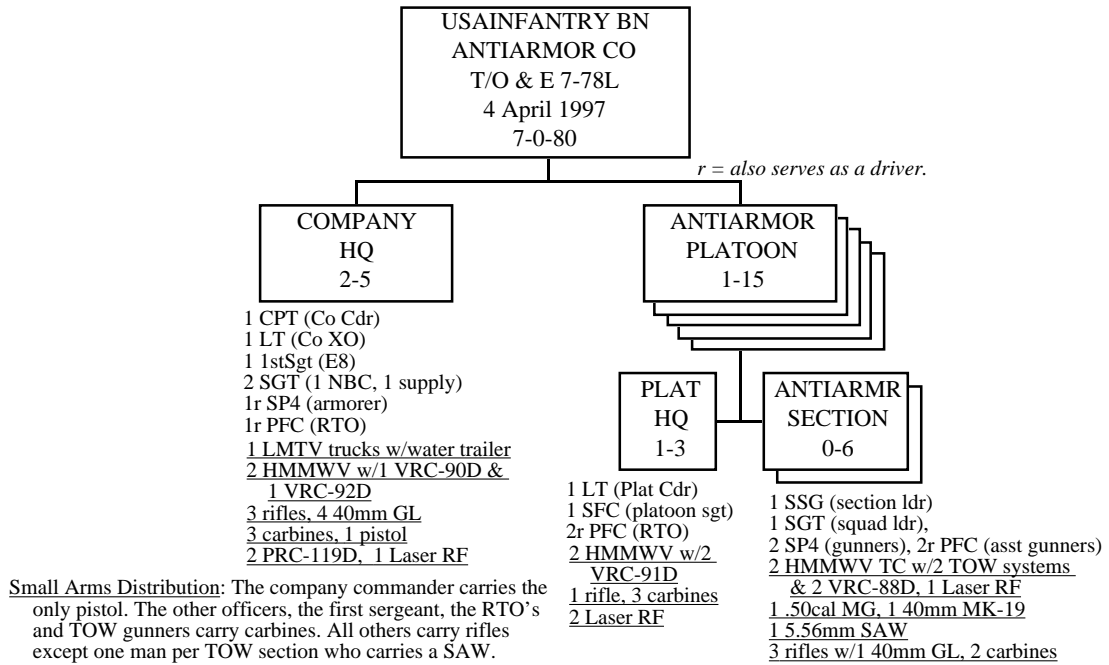

Notes:

Sources: Department of the Army Table of Organization 7-78L "Anti-Armor Company, Infantry Battalion, Infantry Division or Separate Infantry Brigade or Theater Defense Brigade" (Washington DC 4 April 1997)

## Appendix 12.28

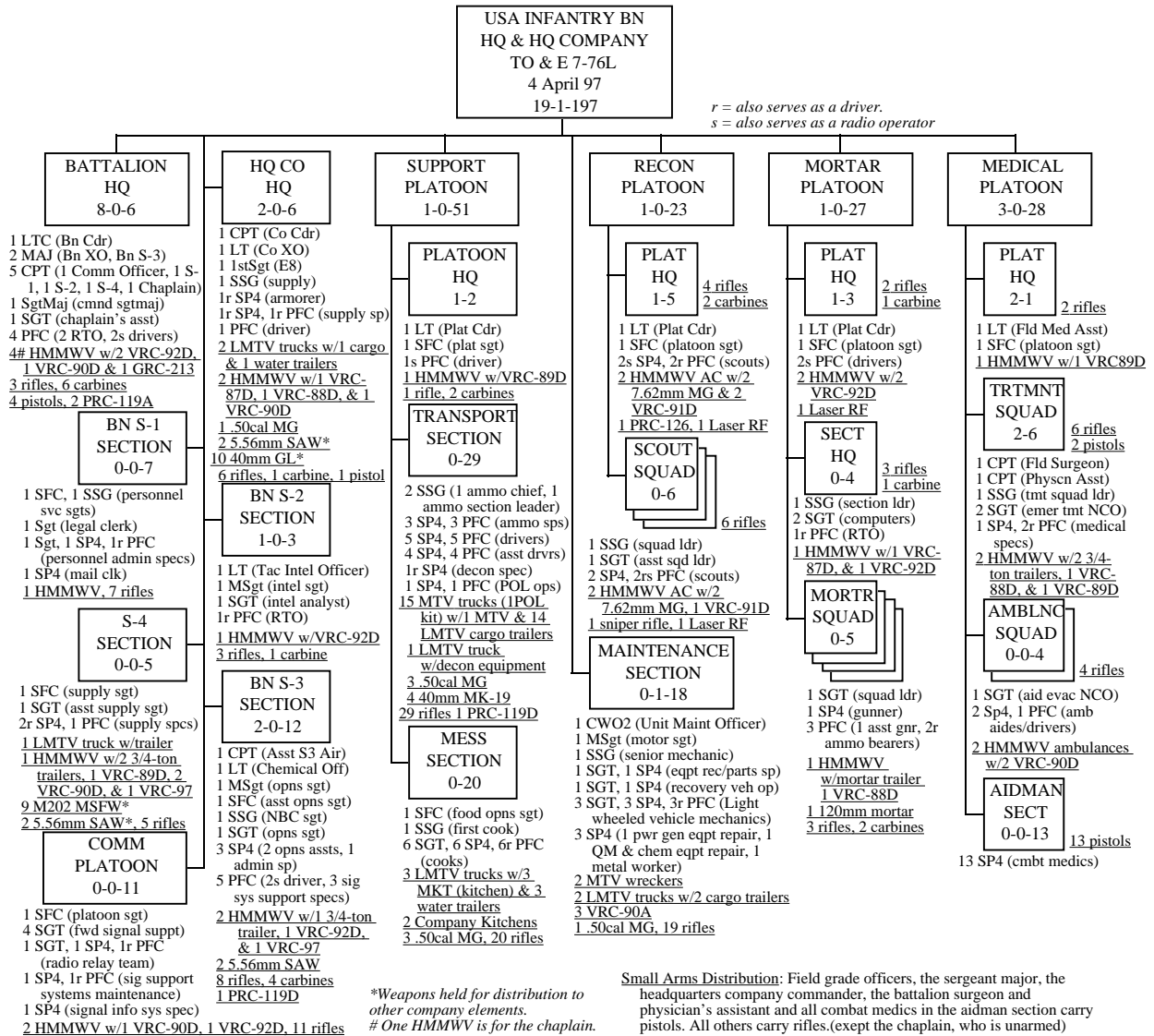

**Appendix 12.29**

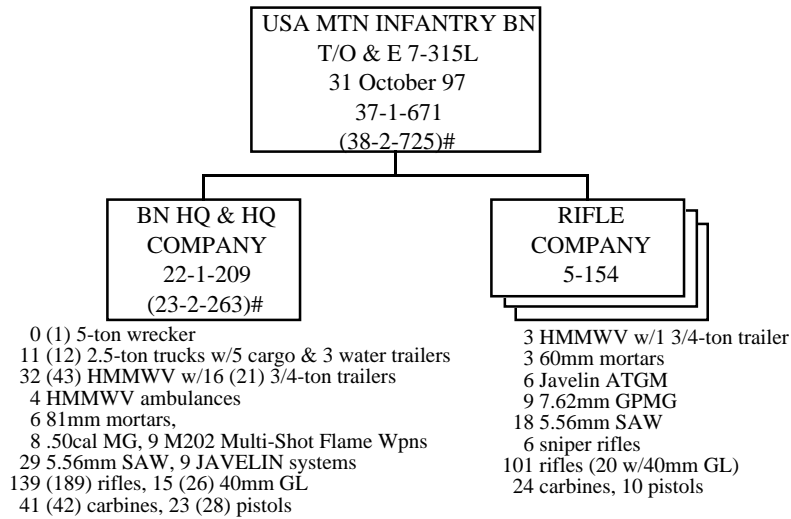

# Information in brackets includes additional units recommended under the Mountain Infantry Battalion Operation and Organization Plan

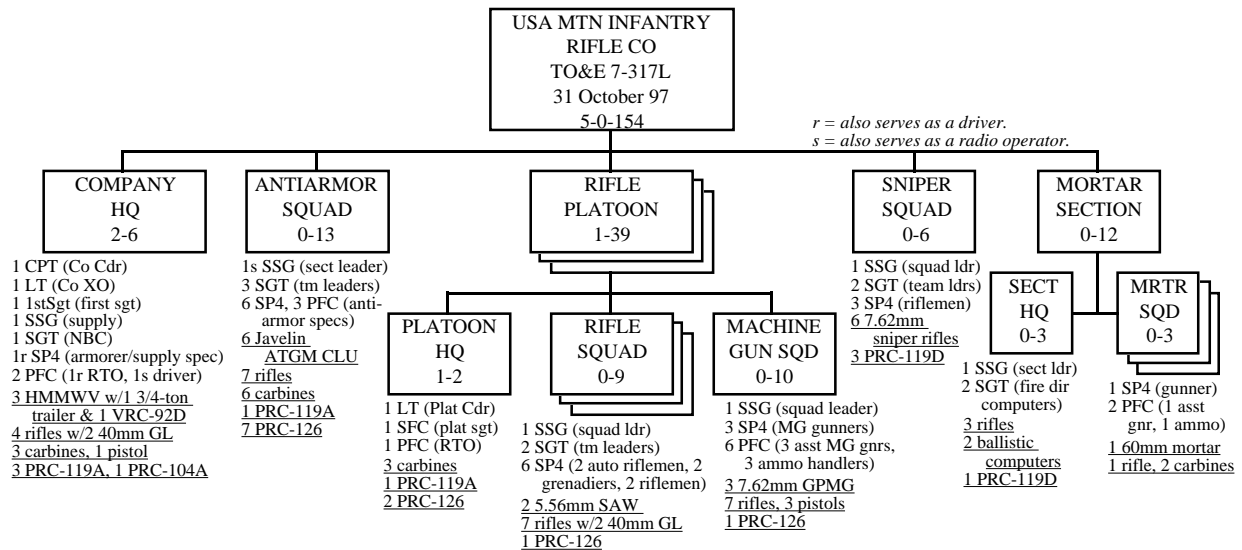

**Small Arms Distribution:** The company commander and all machinegun gunners carry pistols. The other officers, the first sergeant, rifle platoon sergeants, radio-telephone operators (RTO), mortar gunners and assistant gunners, and the six SP4 anti-armor specialists carry carbines. Automatic riflemen carry the SAW. Sniper squad members carry sniper rifles. All others carry rifles.

**Notes:**

**Sources:** Department of the Army Tables of Organization 7-315L "Infantry Battalion, (Mountain) (AOE)" and 7-77L "Rifle Company, Infantry Battalion (Mountain) (AOE)" (both Washington DC 31 October 1997)

## Appendix 12.30

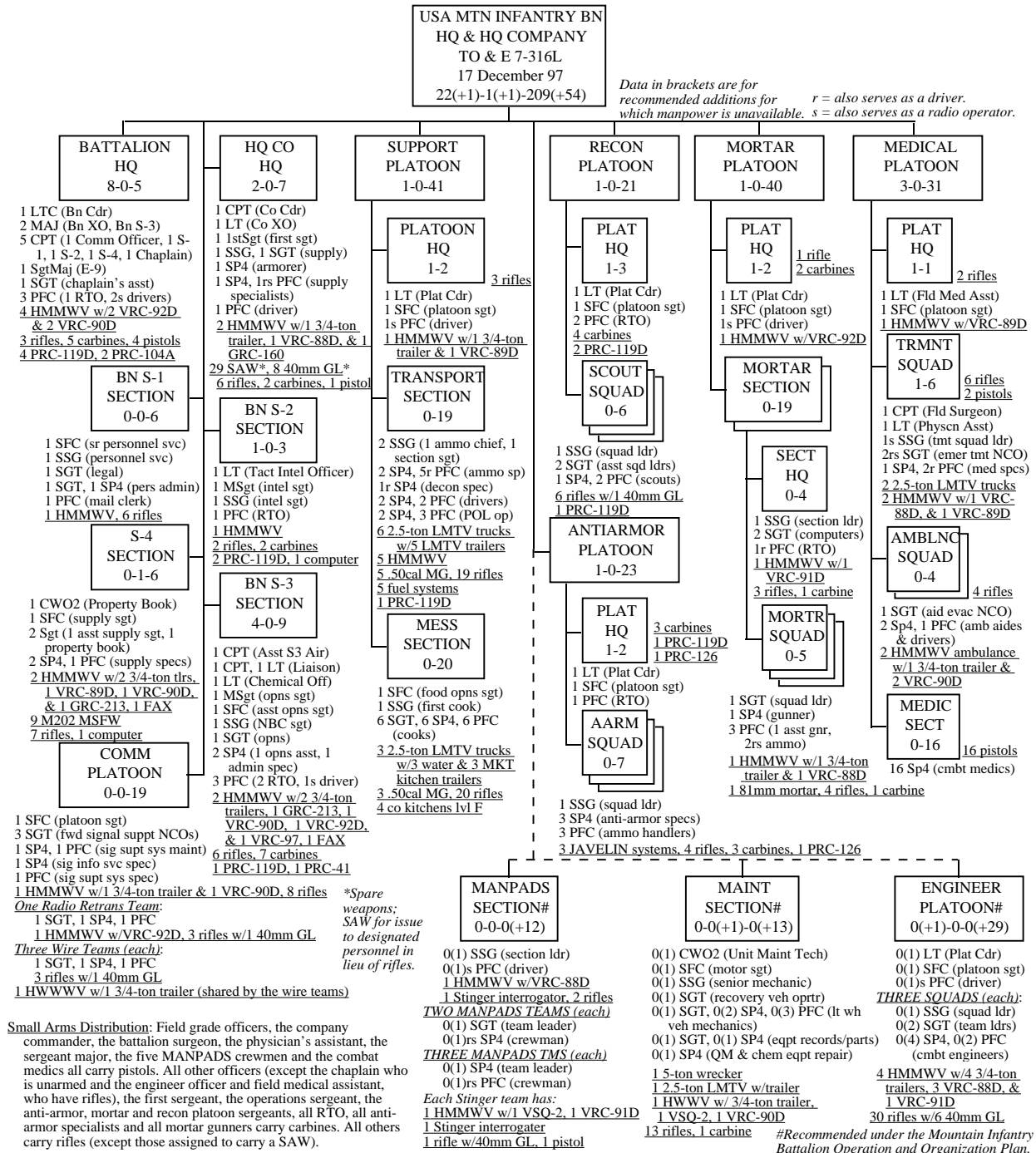

Notes: The communication platoon included a four-man radio Teletype team (with HMMWV and AN/GRC-142) until about 1995 when increased radio capabilities made it unnecessary. As of 1997 manpower with which to staff the engineer platoon and the maintenance and MANPADS (Stinger) sections was still unavailable.

Sources: Department of the Army Table of Organization 7-316L "Headquarters and Headquarters Company, Infantry Battalion, (Mountain) (AOE)" (Washington DC 4 April 1997)